



AIR CONDITIONERS CITY MULTI Series Y, Super Y

Models **PUHY-400YMF-B, 500YMF-B**
PUHY-P400YMF-B, P500YMF-B

PUHY-600YSMF-B, 650YSMF-B, 700YSMF-B, 750YSMF-B
PUHY-P600YSMF-B, P650YSMF-B, P700YSMF-B, P750YSMF-B

Service Handbook

CITY MULTI

Contents

①	PRECAUTIONS FOR DEVICES THAT USE R407C REFRIGERANT	1
	[1] Storage of Piping Material	2
	[2] Piping Machining	3
	[3] Necessary Apparatus and Materials and Notes on Their Handling	4
	[4] Brazing	5
	[5] Airtightness Test.....	6
	[6] Vacuuming	6
	[7] Charging of Refrigerant	7
	[8] Dryer	7
②	COMPONENT OF EQUIPMENT	8
	[1] Appearance of Components	8
	[2] Refrigerant Circuit Diagram and Thermal Sensor	18
	[3] Equipment Composition	22
	[4] Electrical Wiring Diagram	24
	[5] Standard Operation Data	27
	[6] Function of Dip SW and Rotary SW	39
③	TEST RUN	45
	[1] Before Test Run	45
	[2] Test Run Method	52
④	GROUPING REGISTRATION OF INDOOR UNITS WITH REMOTE CONTROLLER	53
⑤	CONTROL.....	59
	[1] Control of Outdoor Unit	59
	[2] Operation Flow Chart	109
	[3] List of Major Component Functions	114
	[4] Resistance of Temperature Sensor	118
⑥	REFRIGERANT AMOUNT ADJUSTMENT	119
	[1] Operating Characteristics and Refrigerant Amount ...	119
	[2] Adjustment and Judgement of Refrigerant Amount ...	119
	[3] Refrigerant Volume Adjustment Mode Operation	122
⑦	TROUBLESHOOTING	129
	[1] Principal Parts	129
	[2] LED monitor display and Countermeasures Depending on the Check Code Displayed	158
	[3] LED Monitor Display	179

Safety precautions

Before installation and electric work

- ▶ **Before installing the unit, make sure you read all the “Safety precautions”.**
- ▶ **The “Safety precautions” provide very important points regarding safety. Make sure you follow them.**
- ▶ **This equipment may not be applicable to EN61000-3-2: 1995 and EN61000-3-3: 1995.**
- ▶ **This equipment may have an adverse effect on equipment on the same electrical supply system.**
- ▶ **Please report to or take consent by the supply authority before connection to the system.**

Symbols used in the text









Warning:

Describes precautions that should be observed to prevent danger of injury or death to the user.

Caution:

Describes precautions that should be observed to prevent damage to the unit.

Symbols used in the illustrations

-  : Indicates an action that must be avoided.
-  : Indicates that important instructions must be followed.
-  : Indicates a part which must be grounded.
-  : Indicates that caution should be taken with rotating parts. (This symbol is displayed on the main unit label.) <Color: Yellow>
-  : Indicates that the main switch must be turned off before servicing. (This symbol is displayed on the main unit label.) <Color: Blue>
-  : Beware of electric shock (This symbol is displayed on the main unit label.) <Color: Yellow>
-  : Beware of hot surface (This symbol is displayed on the main unit label.) <Color: Yellow>
-  **ELV** : Please pay attention to electric shock fully because this is not Safety Extra Low-Voltage (SELV) circuit. And at servicing, please shut down the power supply for both of Indoor Unit and Outdoor Unit.

Warning:

Carefully read the labels affixed to the main unit.

Warning:

- **Ask the dealer or an authorized technician to install the air conditioner.**
 - Improper installation by the user may result in water leakage, electric shock, or fire.
- **Install the air unit at a place that can withstand its weight.**
 - Inadequate strength may cause the unit to fall down, resulting in injuries.
- **Use the specified cables for wiring. Make the connections securely so that the outside force of the cable is not applied to the terminals.**
 - Inadequate connection and fastening may generate heat and cause a fire.

- **Prepare for typhoons and other strong winds and earthquakes and install the unit at the specified place.**
 - Improper installation may cause the unit to topple and result in injury.
- **Always use an air cleaner, humidifier, electric heater, and other accessories specified by Mitsubishi Electric.**
 - Ask an authorized technician to install the accessories. Improper installation by the user may result in water leakage, electric shock, or fire.
- **Never repair the unit. If the air conditioner must be repaired, consult the dealer.**
 - If the unit is repaired improperly, water leakage, electric shock, or fire may result.
- **Do not touch the heat exchanger fins.**
 - Improper handling may result in injury.
- **If refrigerant gas leaks during installation work, ventilate the room.**
 - If the refrigerant gas comes into contact with a flame, poisonous gases will be released.
- **Install the air conditioner according to this Installation Manual.**
 - If the unit is installed improperly, water leakage, electric shock, or fire may result.
- **Have all electric work done by a licensed electrician according to “Electric Facility Engineering Standard” and “Interior Wire Regulations” and the instructions given in this manual and always use a special circuit.**
 - If the power source capacity is inadequate or electric work is performed improperly, electric shock and fire may result.
- **Securely install the cover of control box and the panel.**
 - If the cover and panel are not installed properly, dust or water may enter the outdoor unit and fire or electric shock may result.
- **When installing and moving the air conditioner to another site, do not charge the it with a refrigerant different from the refrigerant (R22/R407C) specified on the unit.**
 - If a different refrigerant or air is mixed with the original refrigerant, the refrigerant cycle may malfunction and the unit may be damaged.
- **If the air conditioner is installed in a small room, measures must be taken to prevent the refrigerant concentration from exceeding the safety limit even if the refrigerant should leak.**
 - Consult the dealer regarding the appropriate measures to prevent the safety limit from being exceeded. Should the refrigerant leak and cause the safety limit to be exceeded, hazards due to lack of oxygen in the room could result.
- **When moving and reinstalling the air conditioner, consult the dealer or an authorized technician.**
 - If the air conditioner is installed improperly, water leakage, electric shock, or fire may result.
- **After completing installation work, make sure that refrigerant gas is not leaking.**
 - If the refrigerant gas leaks and is exposed to a fan heater, stove, oven, or other heat source, it may generate noxious gases.
- **Do not reconstruct or change the settings of the protection devices.**
 - If the pressure switch, thermal switch, or other protection device is shorted and operated forcibly, or parts other than those specified by Mitsubishi Electric are used, fire or explosion may result.

1 PRECAUTIONS FOR DEVICES THAT USE R407C REFRIGERANT

Caution

Do not use the existing refrigerant piping.

- The old refrigerant and refrigerator oil in the existing piping contains a large amount of chlorine which may cause the refrigerator oil of the new unit to deteriorate.

Use refrigerant piping made of C1220 (CU-DHP) phosphorus deoxidized copper as specified in the *JIS H3300 “Copper and copper alloy seamless pipes and tubes”. In addition, be sure that the inner and outer surfaces of the pipes are clean and free of hazardous sulphur, oxides, dust/dirt, shaving particles, oils, moisture, or any other contaminant.

- Contaminants on the inside of the refrigerant piping may cause the refrigerant residual oil to deteriorate.

*JIS: Japanese Industrial Standard

Store the piping to be used during installation indoors and keep both ends of the piping sealed until just before brazing. (Store elbows and other joints in a plastic bag.)

- If dust, dirt, or water enters the refrigerant cycle, deterioration of the oil and compressor trouble may result.

Use ester oil, ether oil or alkylbenzene (small amount) as the refrigerator oil to coat flares and flange connections.

- The refrigerator oil will degrade if it is mixed with a large amount of mineral oil.

Use liquid refrigerant to seal the system.

- If gas refrigerant is used to seal the system, the composition of the refrigerant in the cylinder will change and performance may drop.

Do not use a refrigerant other than R407C.

- If another refrigerant (R22, etc.) is used, the chlorine in the refrigerant may cause the refrigerator oil to deteriorate.

Use a vacuum pump with a reverse flow check valve.

- The vacuum pump oil may flow back into the refrigerant cycle and cause the refrigerator oil to deteriorate.

Do not use the following tools that have been used with conventional refrigerants.

(Gauge manifold, charge hose, gas leak detector, reverse flow check valve, refrigerant charge base, vacuum gauge, refrigerant recovery equipment)

- If the conventional refrigerant and refrigerator oil are mixed in the R407C, the refrigerant may deteriorate.
- If water is mixed in the R407C, the refrigerator oil may deteriorate.
- Since R407C does not contain any chlorine, gas leak detectors for conventional refrigerants will not react to it.

Do not use a charging cylinder.

- Using a charging cylinder may cause the refrigerant to deteriorate.

Be especially careful when managing the tools.

- If dust, dirt, or water gets in the refrigerant cycle, the refrigerant may deteriorate.

If the refrigerant leaks, recover the refrigerant in the refrigerant cycle, then recharge the cycle with the specified amount of the liquid refrigerant indicated on the air conditioner.

- Since R407C is a nonazeotropic refrigerant, if additionally charged when the refrigerant leaked, the composition of the refrigerant in the refrigerant cycle will change and result in a drop in performance or abnormal stopping.

[1] Storage of Piping Material

(1) Storage location

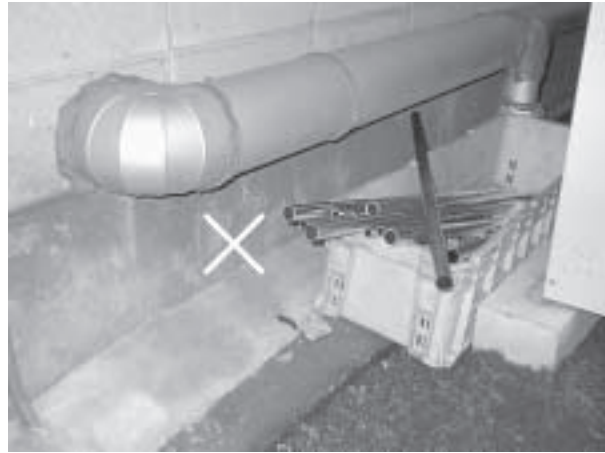
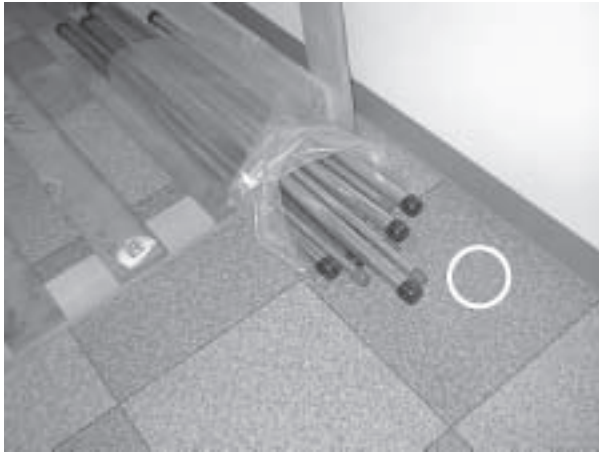

Store the pipes to be used indoors. (Warehouse at site or owner's warehouse)
Storing them outdoors may cause dirt, waste, or water to infiltrate.

(2) Pipe sealing before storage

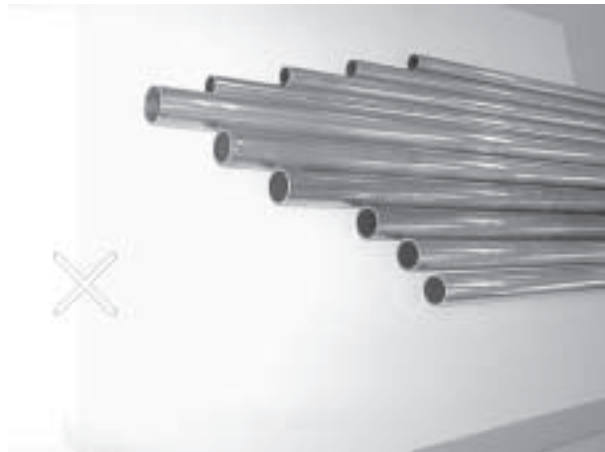
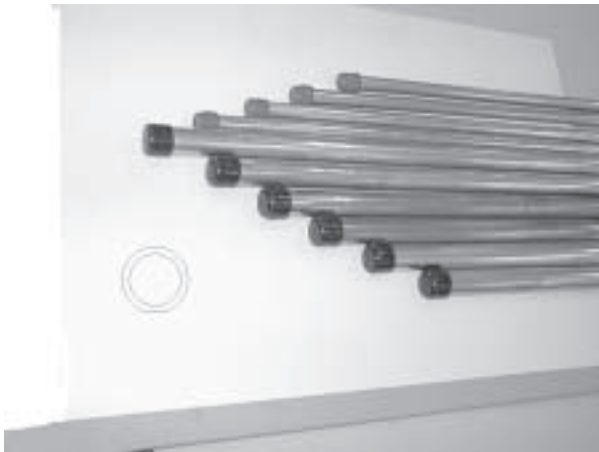

Both ends of the pipes should be sealed until immediately before brazing.
Wrap elbows and T's in plastic bags for storage.

* The new refrigerator oil is 10 times more hygroscopic than the conventional refrigerator oil (such as Suniso). Water infiltration in the refrigerant circuit may deteriorate the oil or cause a compressor failure. Piping materials must be stored with more care than with the conventional refrigerant pipes.

[2] Piping Machining

Use ester oil, ether oil or alkylbenzene (small amount) as the refrigerator oil to coat flares and flange connections.

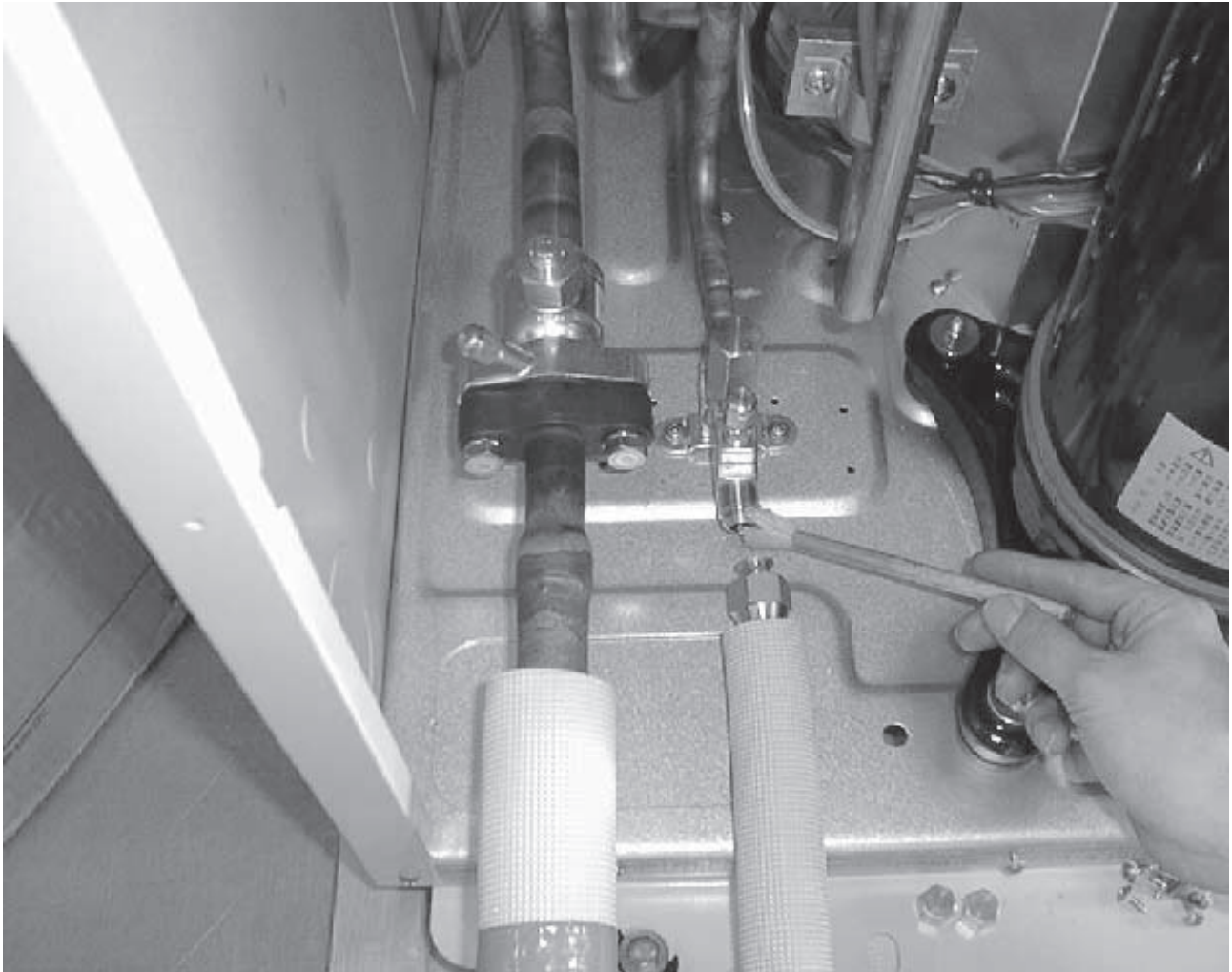

Use only the necessary minimum quantity of oil !

Reason:

1. The refrigerator oil used for the equipment is highly hygroscopic and may introduce water inside.

Notes:

- Introducing a great quantity of mineral oil into the refrigerant circuit may also cause a compressor failure.
- Do not use oils other than ester oil, ether oil or alkylbenzene.

[3] Necessary Apparatus and Materials and Notes on Their Handling

The following tools should be marked as dedicated tools for R407C.

<<Comparison of apparatus and materials used for R407C and for R22>>

Apparatus Used	Use	R22	R407C
Gauge manifold	Evacuating, refrigerant filling	Current product	⊙
Charging hose	Operation check	Current product	⊙
Charging cylinder	Refrigerant charging	Current product	⊙ Do not use.
Gas leakage detector	Gas leakage check	Current product	⊙ Shared with R134a
Refrigerant collector	Refrigerant collection	R22	⊙ For R407C use only
Refrigerant cylinder	Refrigerant filling	R22	⊙ Identification of dedicated use for R407C : Record refrigerant name and put brown belt on upper part of cylinder.
Vacuum pump	Vacuum drying	Current product	△ Can be used by attaching an adapter with a check valve.
Vacuum pump with a check valve		Current product	△
Flare tool	Flaring of pipes	Current product	△
Bender	Bending of pipes	Current product	△
Application oil	Applied to flared parts	Current product	⊙ Ester oil or Ether oil or Alkybenzene (Small amount)
Torque wrench	Tightening of flare nuts	Current product	△
Pipe cutter	Cutting of pipes	Current product	△
Welder and nitrogen cylinder	Welding of pipes	Current product	△
Refrigerant charging meter	Refrigerant charging	Current product	△
Vacuum gauge	Checking the vacuum degree	Current product	△

Symbols: ⊙ To be used for R407C only.

△ Can also be used for conventional refrigerants.

Tools for R407C must be handled with more care than those for conventional refrigerants. They must not come into contact with any water or dirt.

[4] Brazing

No changes from the conventional method, but special care is required so that foreign matter (ie. oxide scale, water, dirt, etc.) does not enter the refrigerant circuit.

Example: Inner state of brazed section

When non-oxide brazing was not used

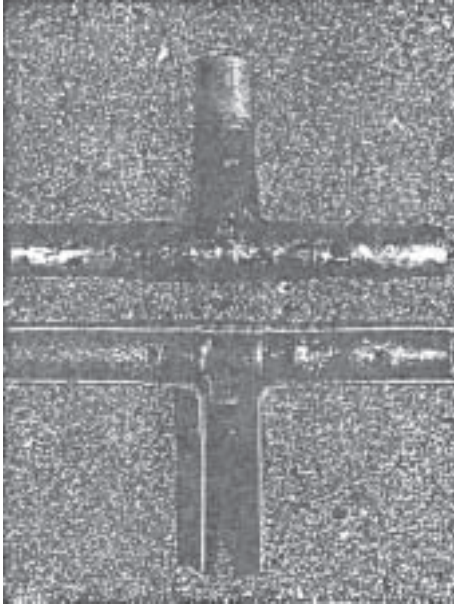

When non-oxide brazing was used

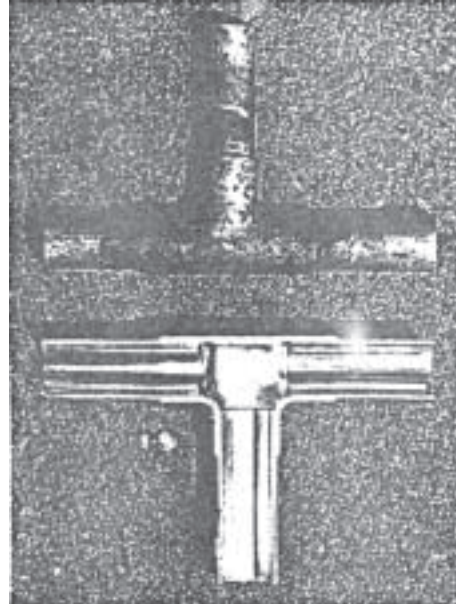

Items to be strictly observed:

1. Do not conduct refrigerant piping work outdoors on a rainy day.
2. Apply non-oxide brazing.
3. Use a brazing material (Bcup-3) which requires no flux when brazing between copper pipes or between a copper pipe and copper coupling.
4. If installed refrigerant pipes are not immediately connected to the equipment, then braze and seal both ends of them.

Reasons:

1. The new refrigerant oil is 10 times more hygroscopic than the conventional oil. The probability of a machine failure if water infiltrates is higher than with conventional refrigerant oil.
2. A flux generally contains chlorine. A residual flux in the refrigerant circuit may generate sludge.

Note:

- Commercially available antioxidants may have adverse effects on the equipment due to its residue, etc. When applying non-oxide brazing, use nitrogen.

[5] Airtightness Test

No changes from the conventional method. Note that a refrigerant leakage detector for R22 cannot detect R407C leakage.

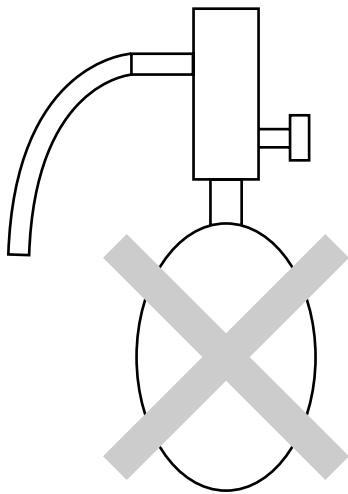

Halide torch

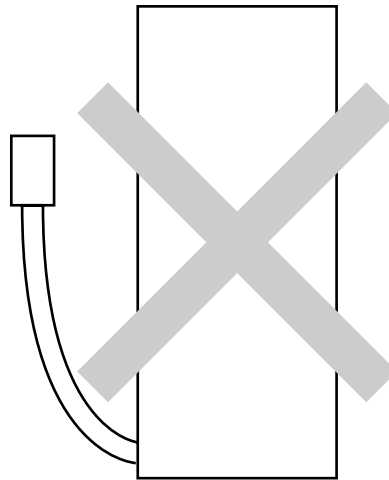

R22 leakage detector

Items to be strictly observed:

1. Pressurize the equipment with nitrogen up to the design pressure and then judge the equipment's airtightness, taking temperature variations into account.
2. When investigating leakage locations using a refrigerant, be sure to use R407C.
3. Ensure that R407C is in a liquid state when charging.

Reasons:

1. Use of oxygen as the pressurized gas may cause an explosion.
2. Charging with R407C gas will lead the composition of the remaining refrigerant in the cylinder to change and this refrigerant can then not be used.

Note:

- A leakage detector for R407C is sold commercially and it should be purchased.

[6] Vacuuming

1. Vacuum pump with check valve

A vacuum pump with a check valve is required to prevent the vacuum pump oil from flowing back into the refrigerant circuit when the vacuum pump power is turned off (power failure).

It is also possible to attach a check valve to the actual vacuum pump afterwards.

2. Standard degree of vacuum for the vacuum pump

Use a pump which reaches 0.5 Torr (500 MICRON) or below after 5 minutes of operation.

In addition, be sure to use a vacuum pump that has been properly maintained and oiled using the specified oil. If the vacuum pump is not properly maintained, the degree of vacuum may be too low.

3. Required accuracy of the vacuum gauge

Use a vacuum gauge that can measure up to 5 Torr. Do not use a general gauge manifold since it cannot measure a vacuum of 5 Torr.

4. Evacuating time

- Evacuate the equipment for 1 hour after – 755 mmHg (5 Torr) has been reached.
- After envacuating, leave the equipment for 1 hour and make sure the that vacuum is not lost.

5. Operating procedure when the vacuum pump is stopped

In order to prevent a backflow of the vacuum pump oil, open the relief valve on the vacuum pump side or loosen the charge hose to drawn in air before stopping operation.

The same operating procedure should be used when using a vacuum pump with a check valve.

[7] Charging of Refrigerant

R407C must be in a liquid state when charging, because it is a non-azeotropic refrigerant.

For a cylinder with a syphon attached

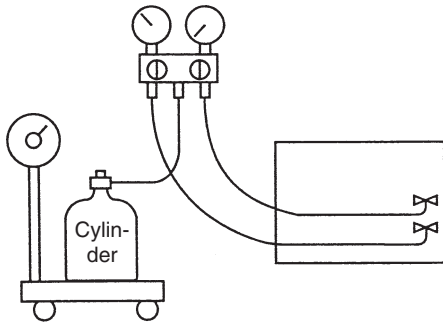

For a cylinder without a syphon attached

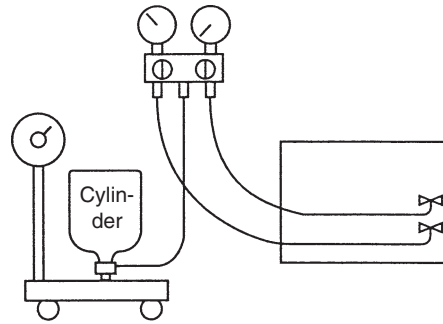

Cylinder color identification
R407C-Gray
R410A-Pink

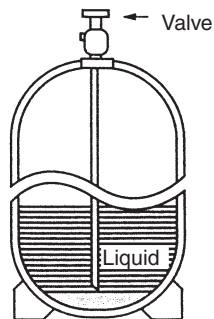

Charged with liquid refrigerant

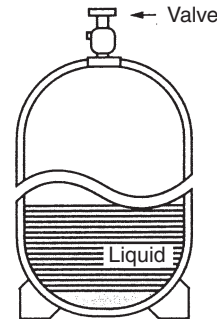

Reasons:

1. R407C is a mixture of 3 refrigerants, each with a different evaporation temperature. Therefore, if the equipment is charged with R407C gas, then the refrigerant whose evaporation temperature is closest to the outside temperature is charged first while the rest of refrigerants remain in the cylinder.

Note:

- In the case of a cylinder with a syphon, liquid R407C is charged without turning the cylinder up side down. Check the type of cylinder before charging.

[8] Dryer

1. Replace the dryer when the refrigerant circuit is opened (Ex. Change the compressor, full gas leakage). Be sure to replace the dryer with a CITY MULTI Series Y, Super Y (For use with R407C).

If any other product is used, the unit will be damaged.

2. Opening the refrigerant circuit after changing to a new dryer is less than 1 hour. The replacement of the dryer should be the last operation performed.

2 COMPONENT OF EQUIPMENT

[1] Appearance of Components

① Variable capacity unit

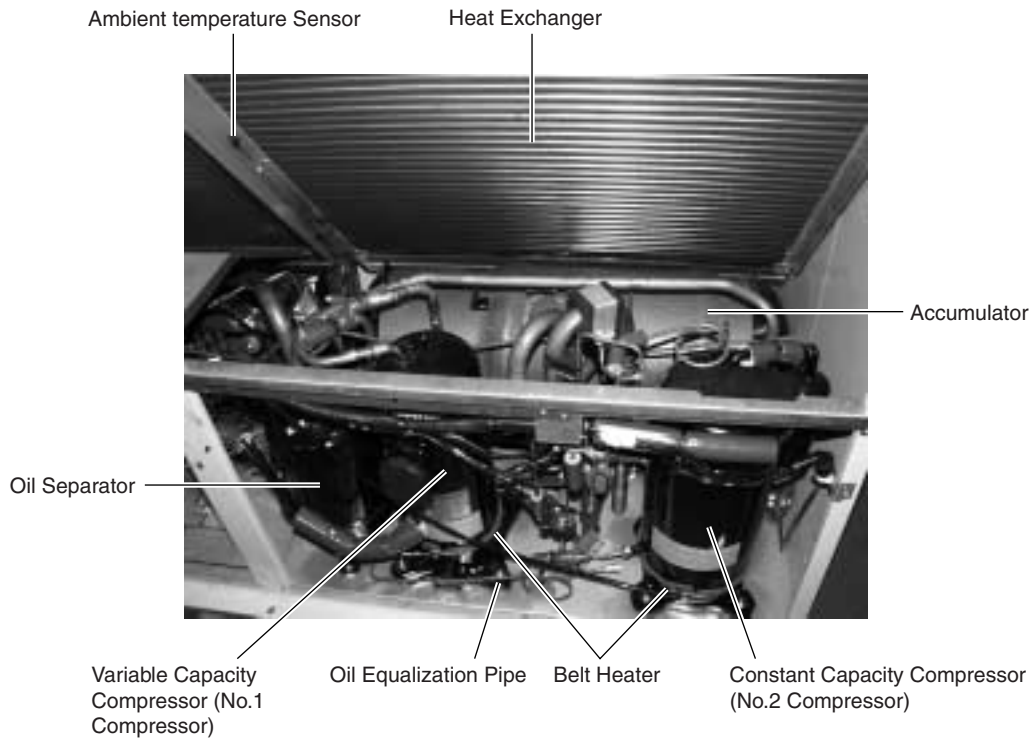

Rear

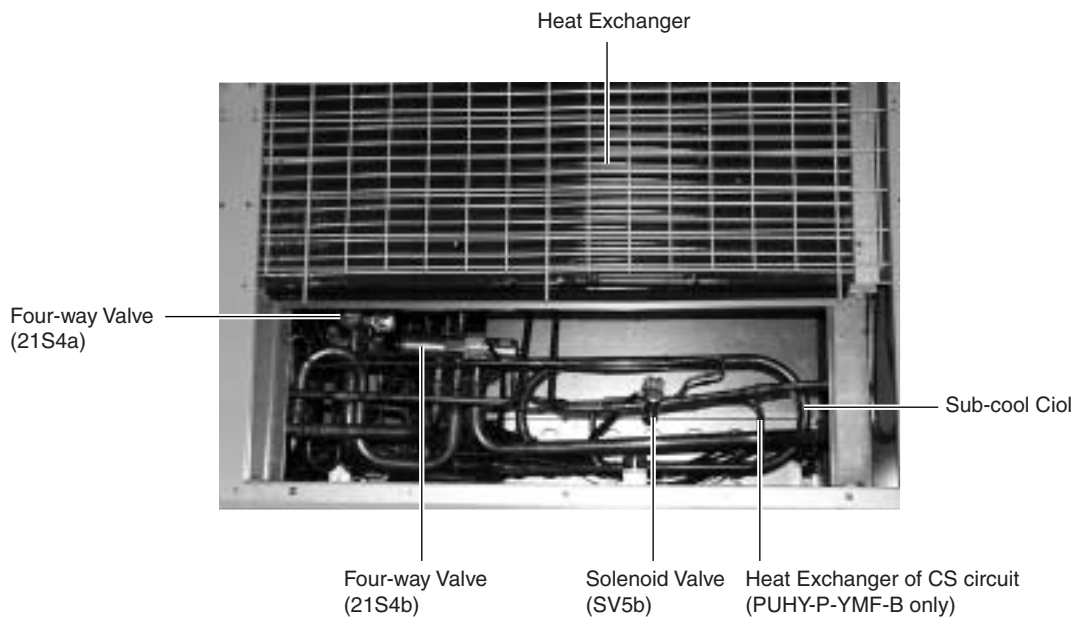

Controller Box

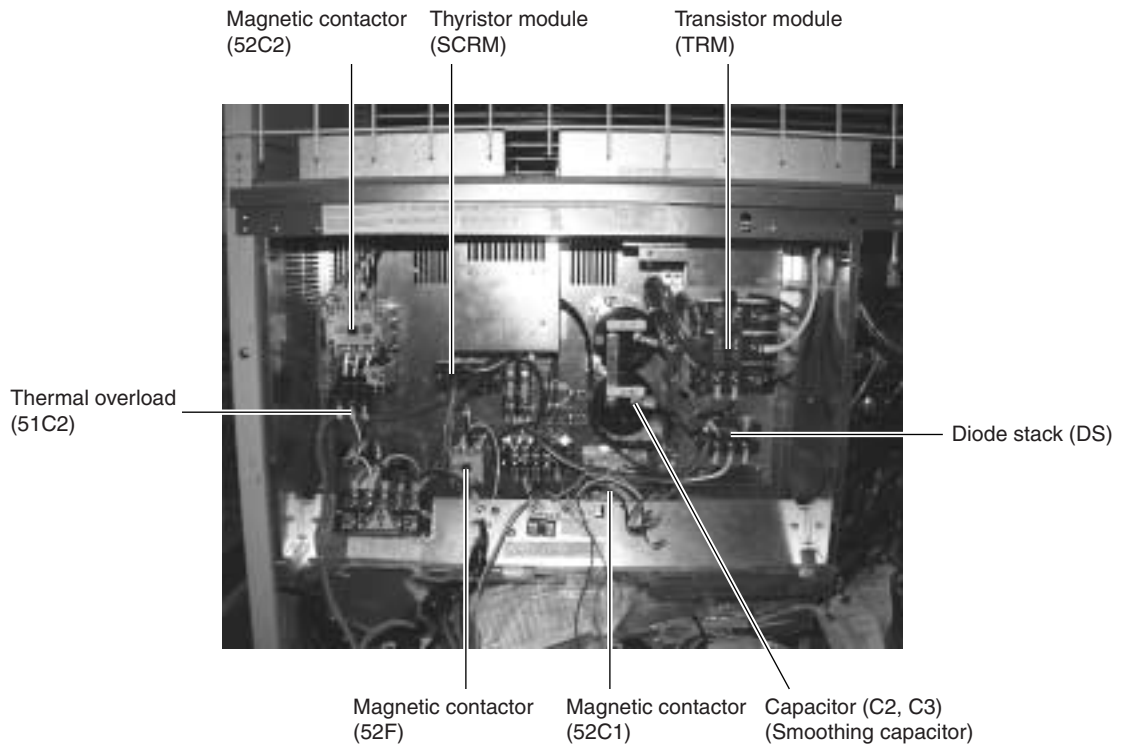
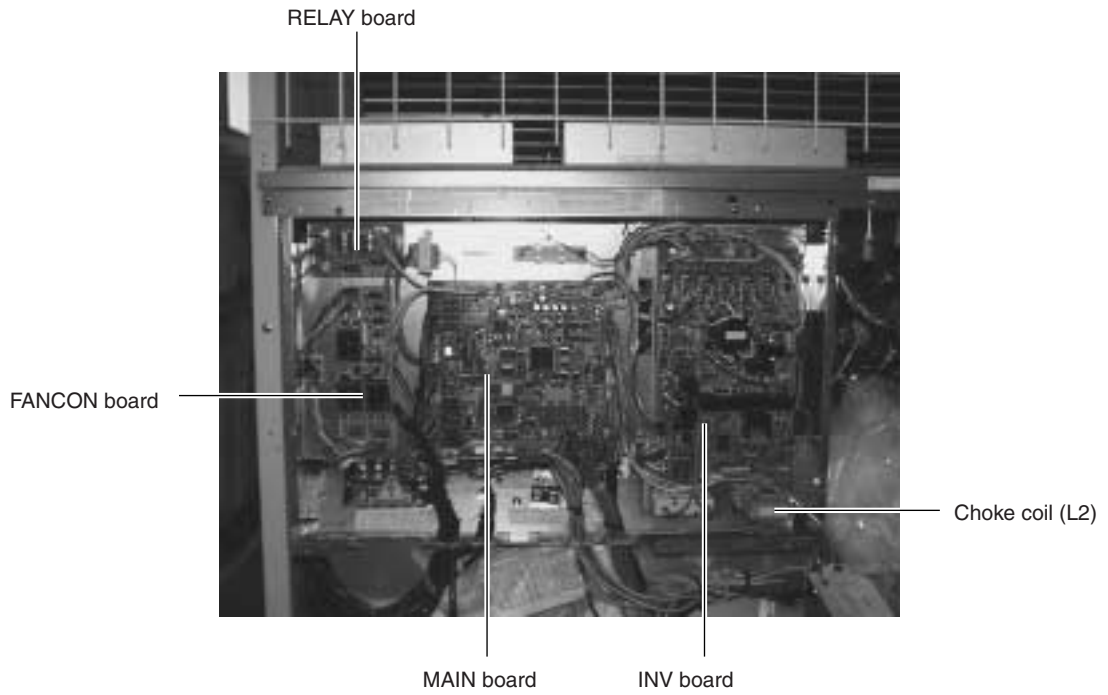

Noise Filter Box

(Rear of the controller box)

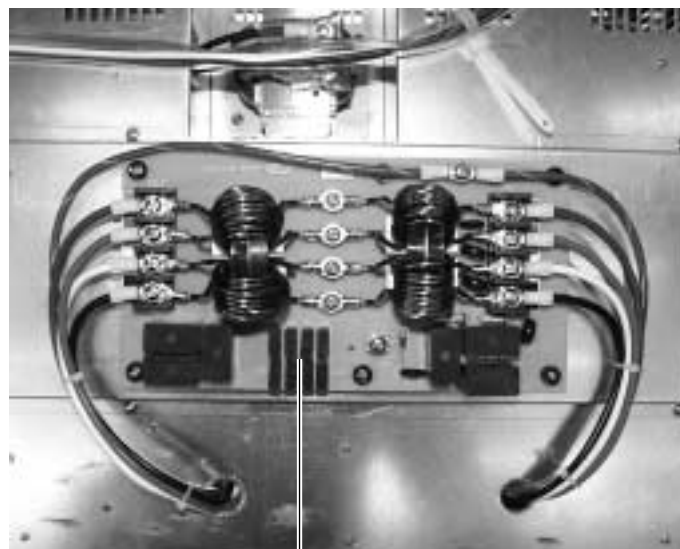
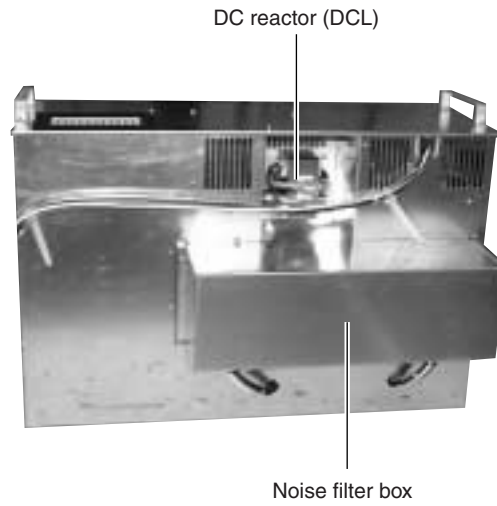

MAIN board

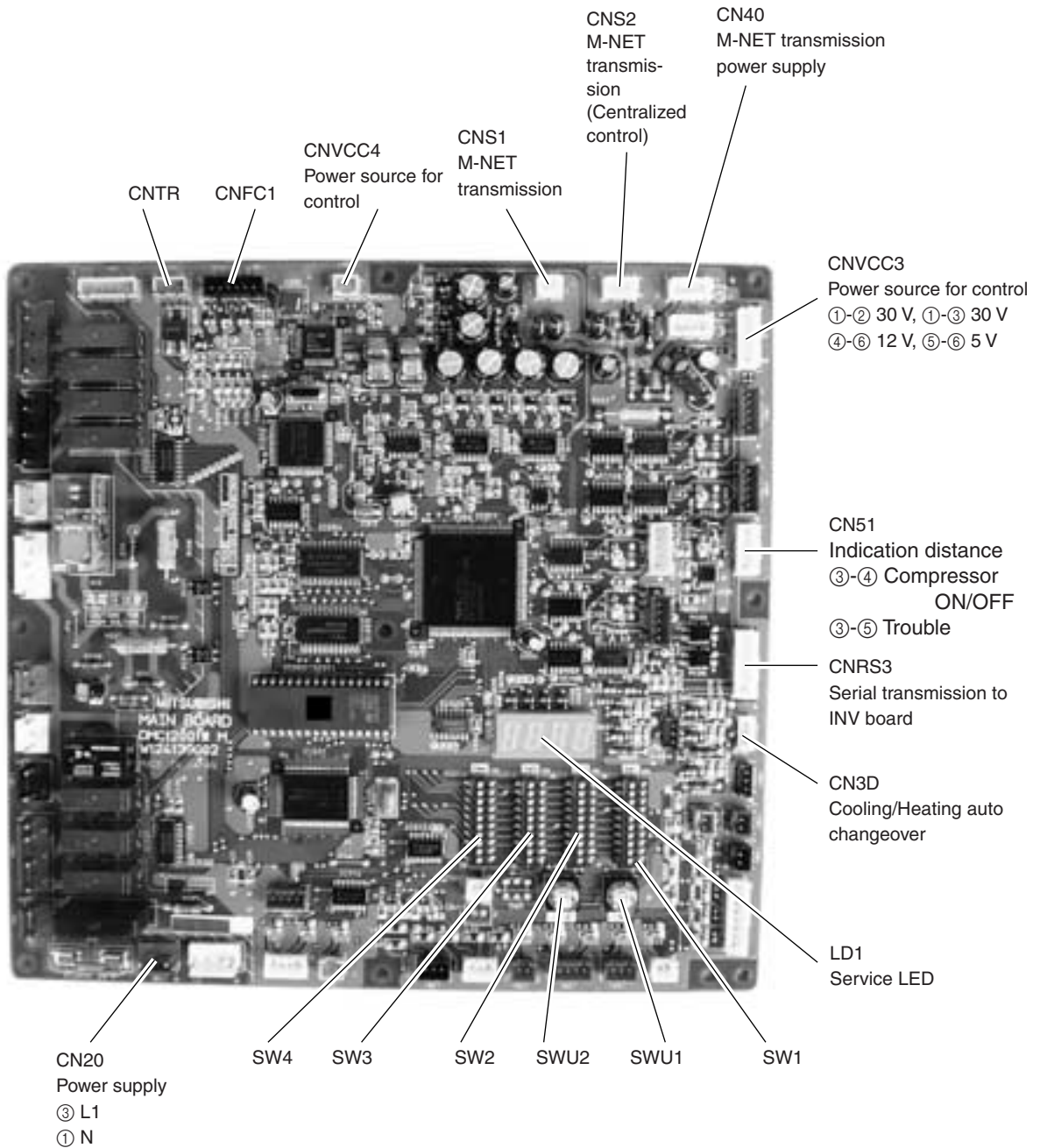

INV board

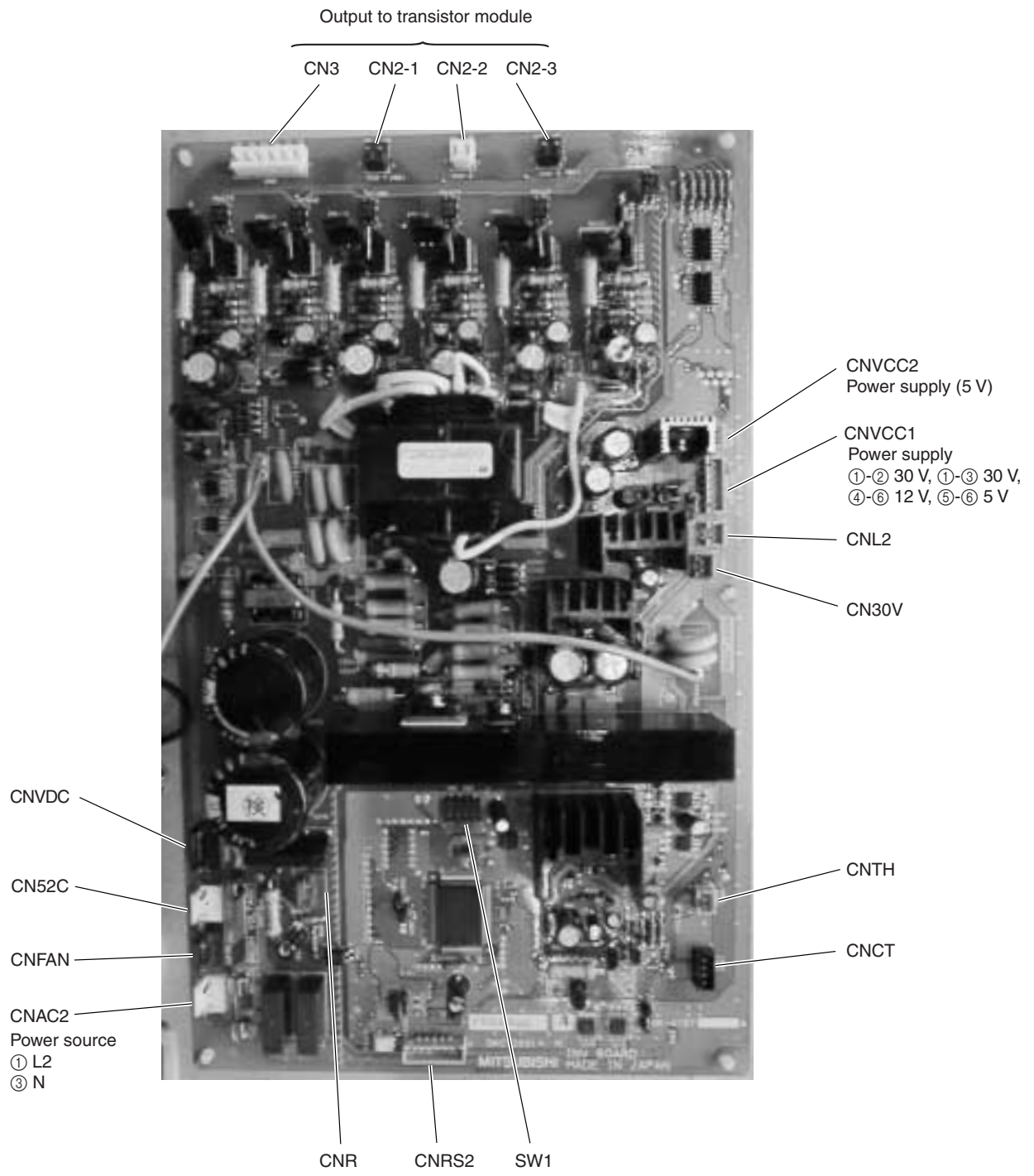

FANCON board

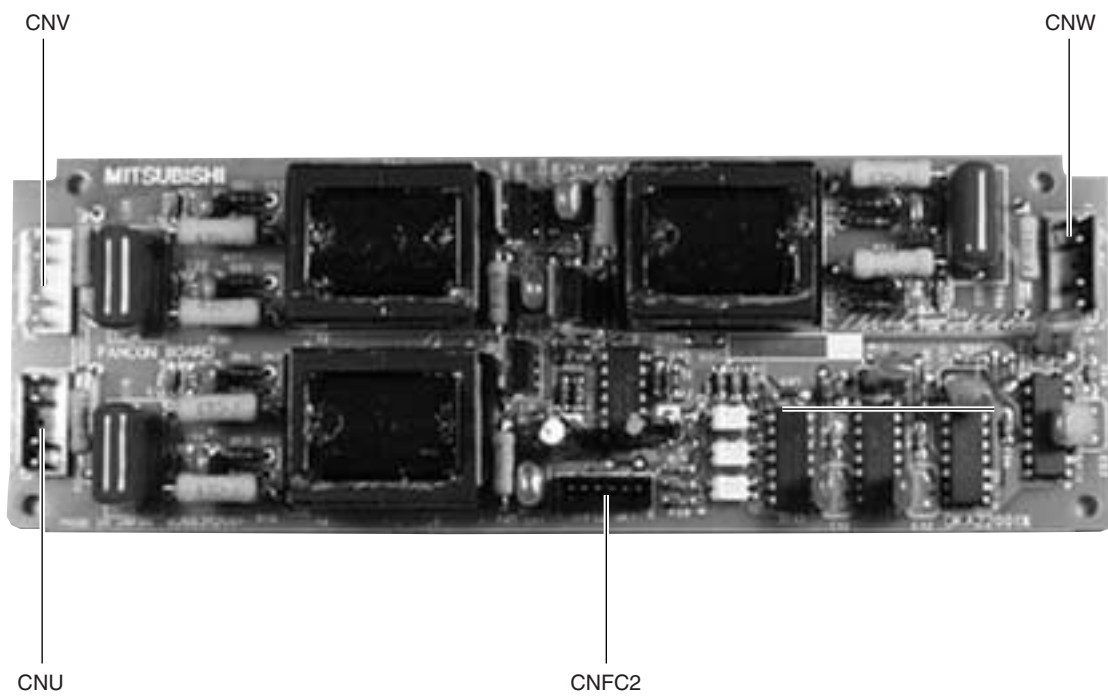

RELAY board

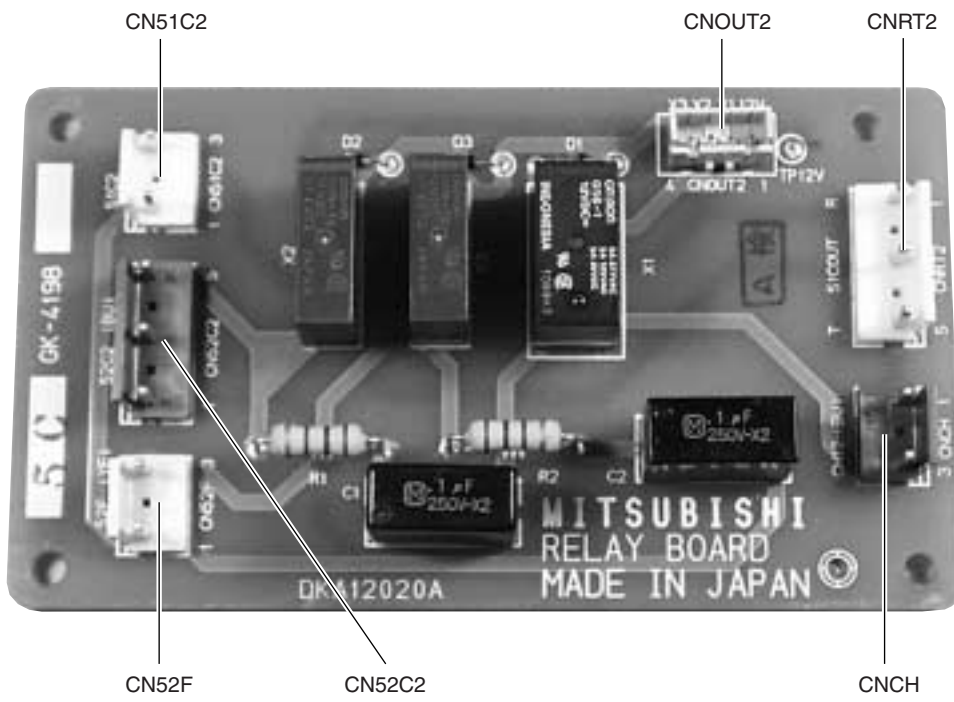

② Constant capacity unit

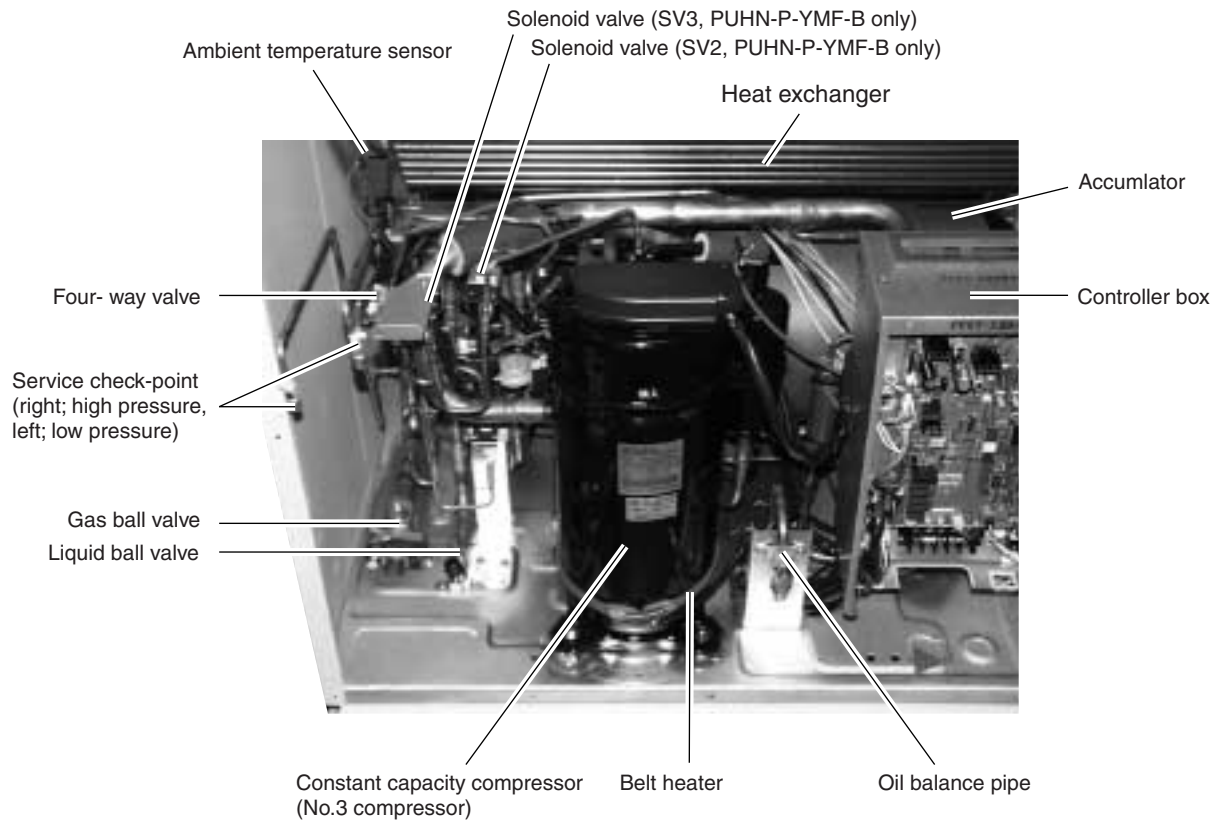

Rear

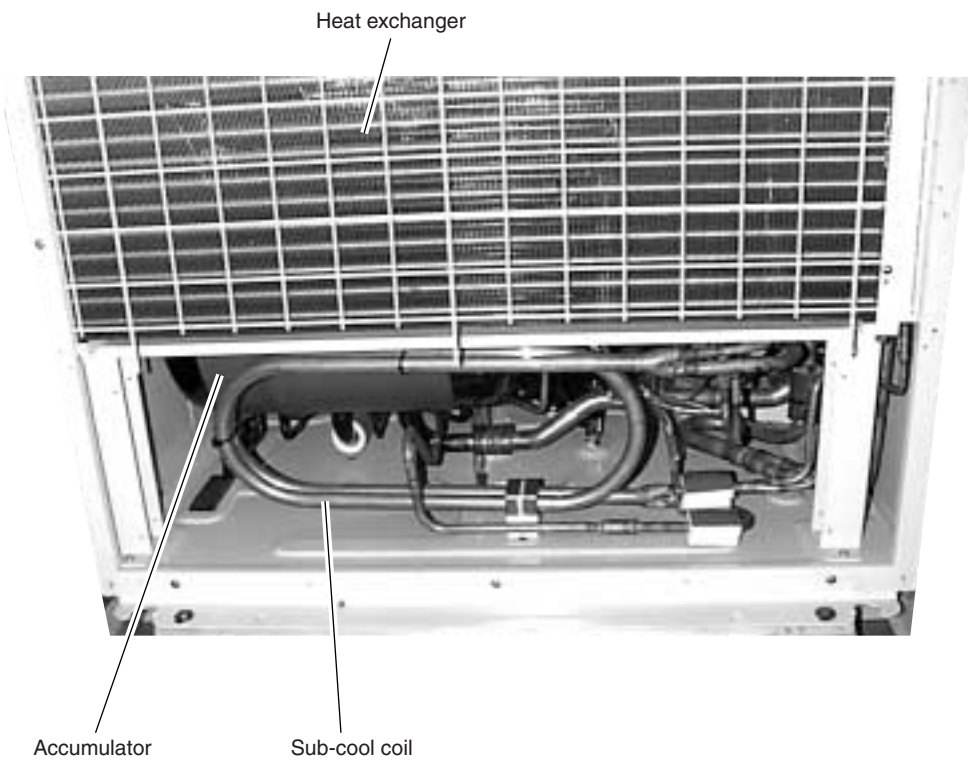

Controller Box

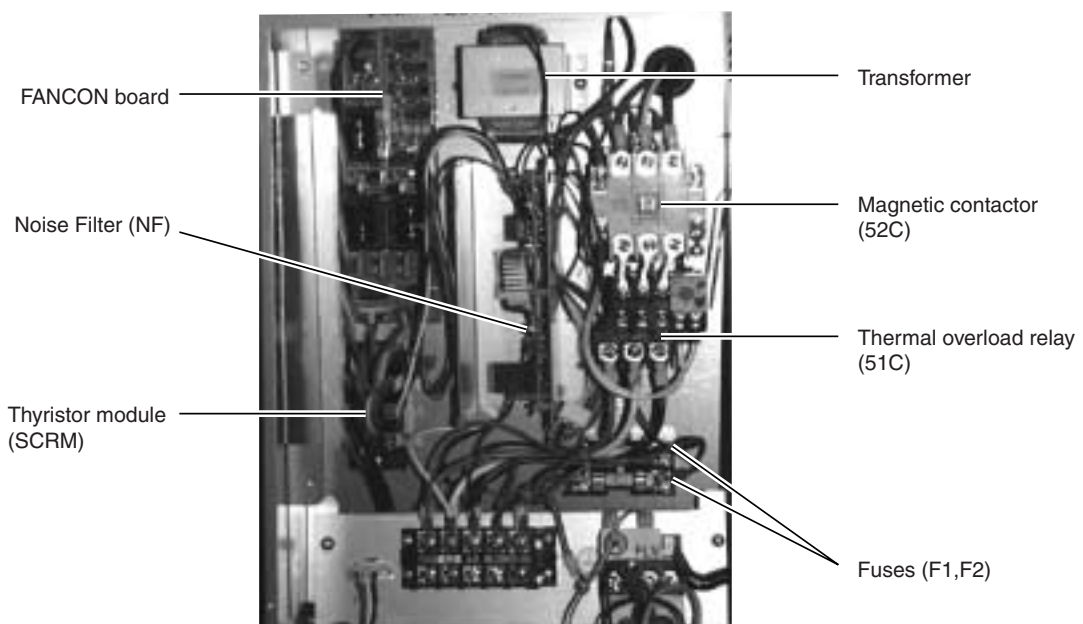
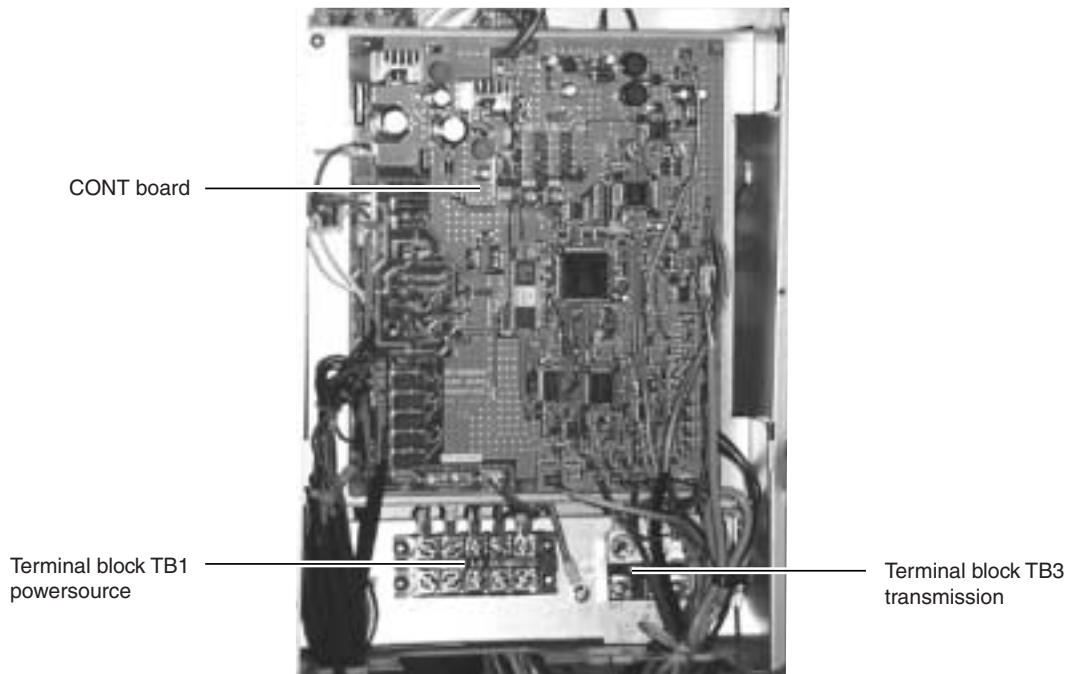

CONT board

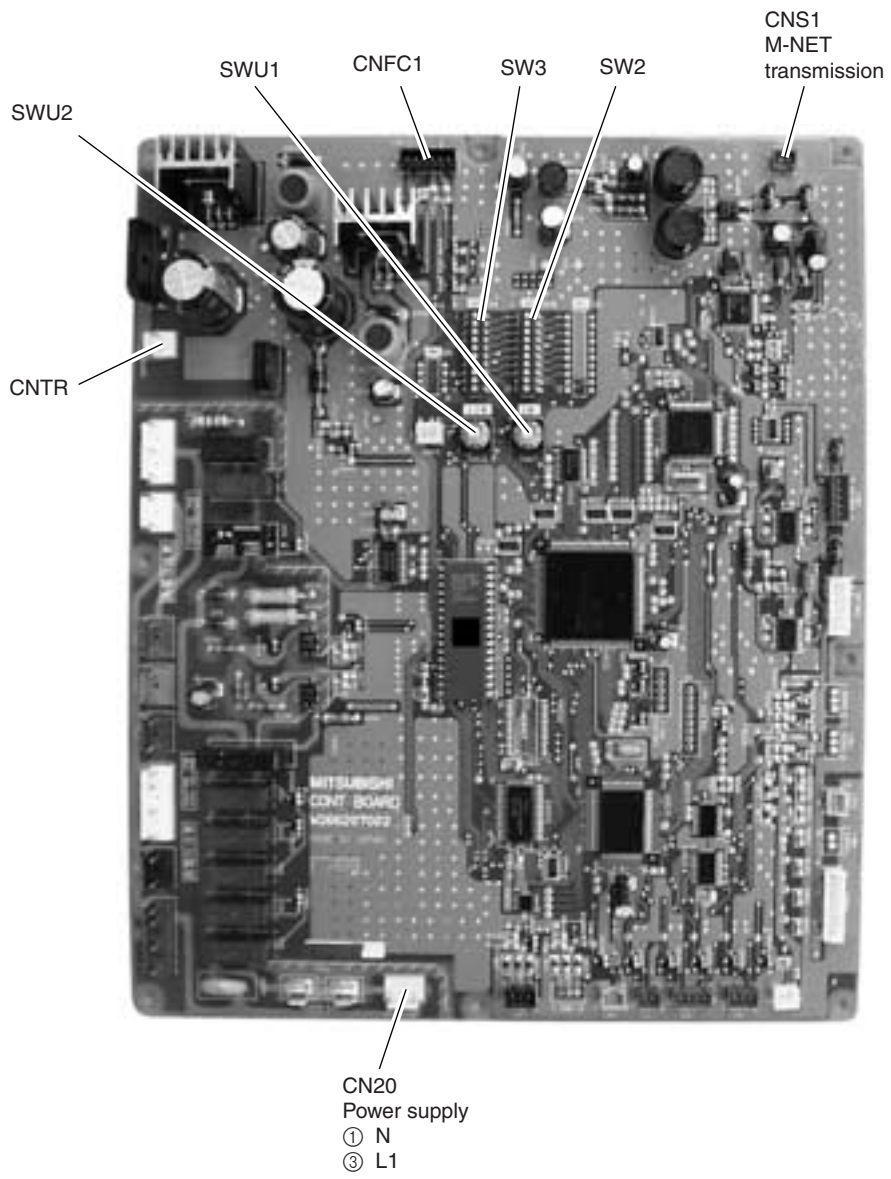

[2] Refrigerant Circuit Diagram and Thermal Sensor

① PUHY-P400-500YMF-B

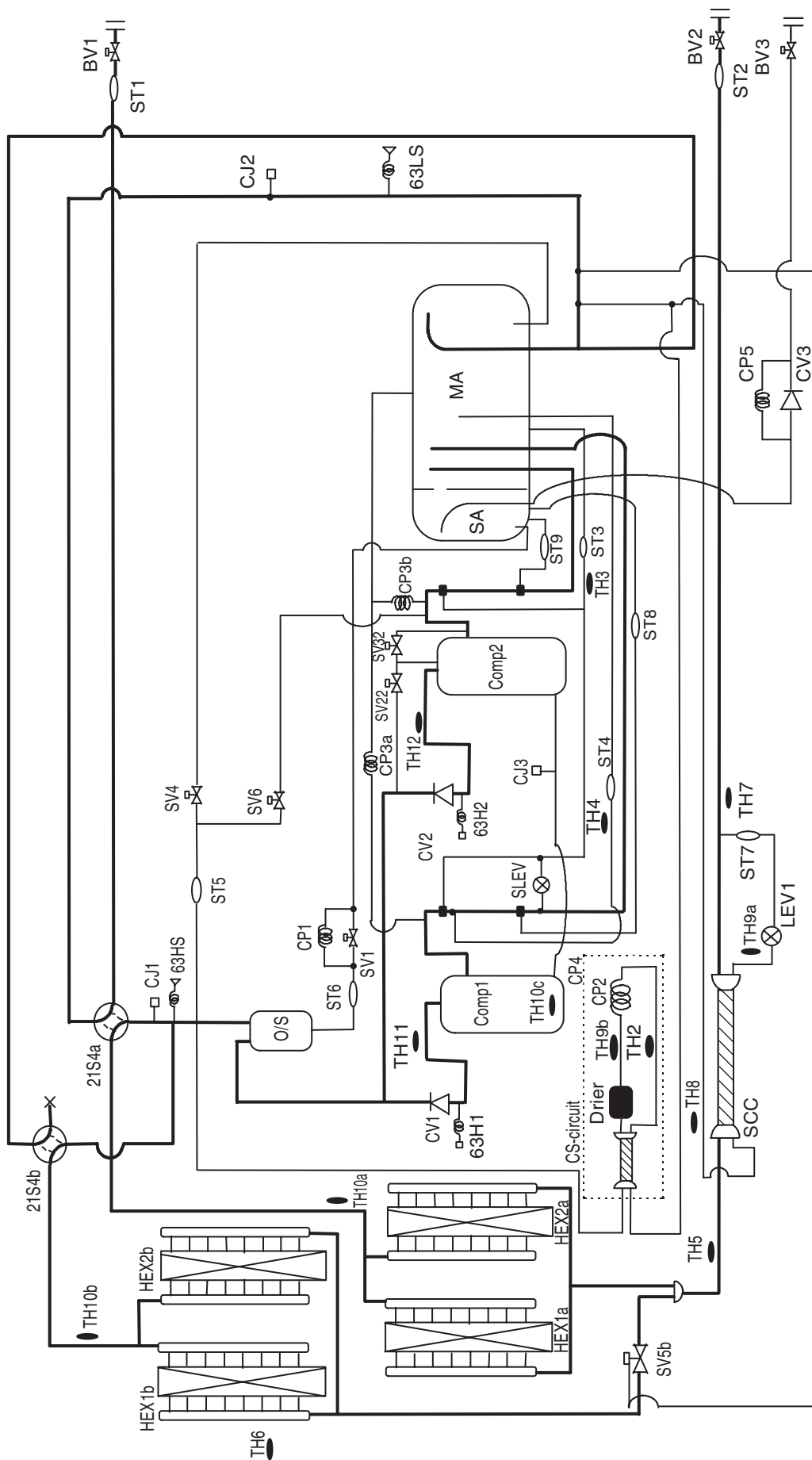

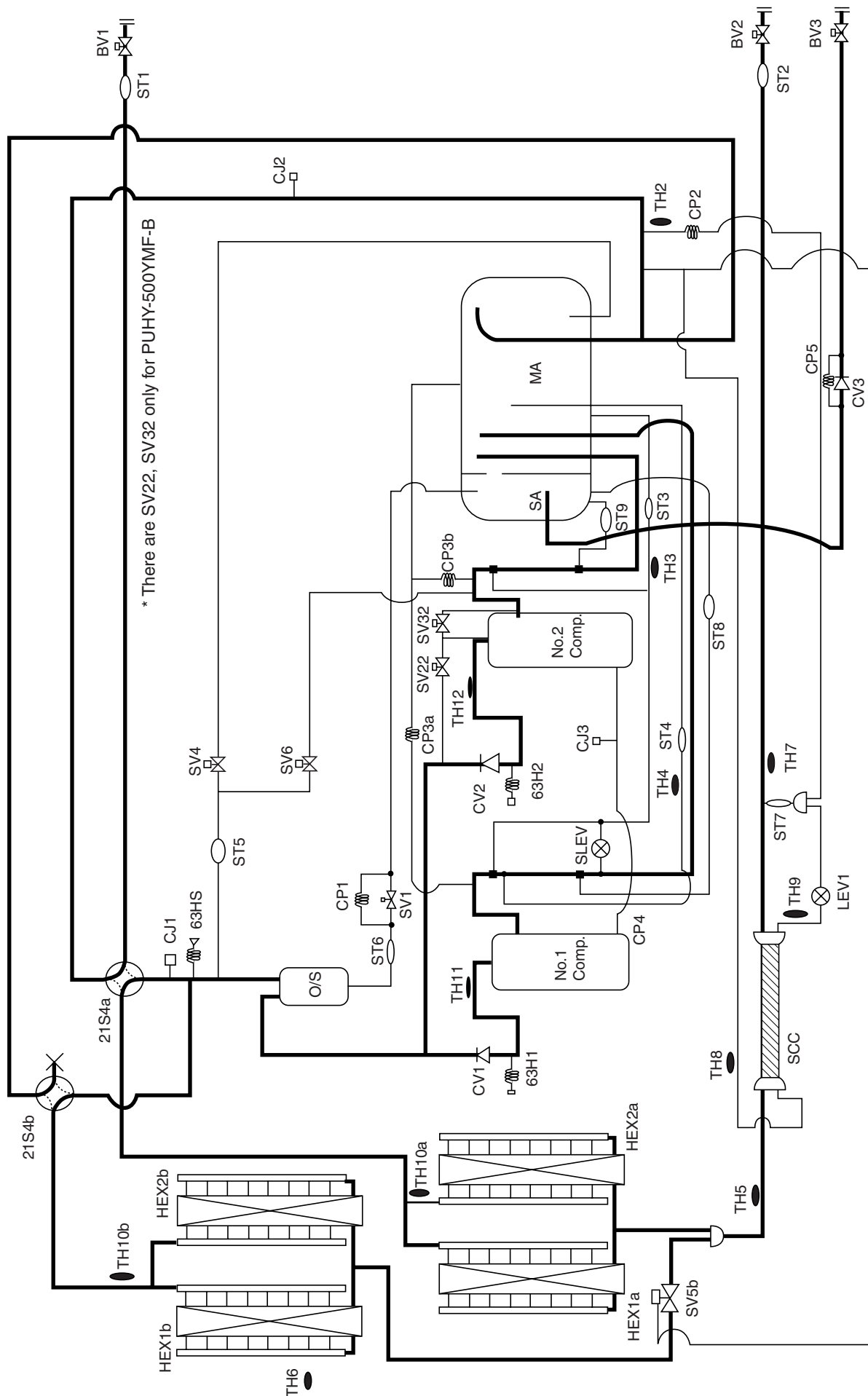

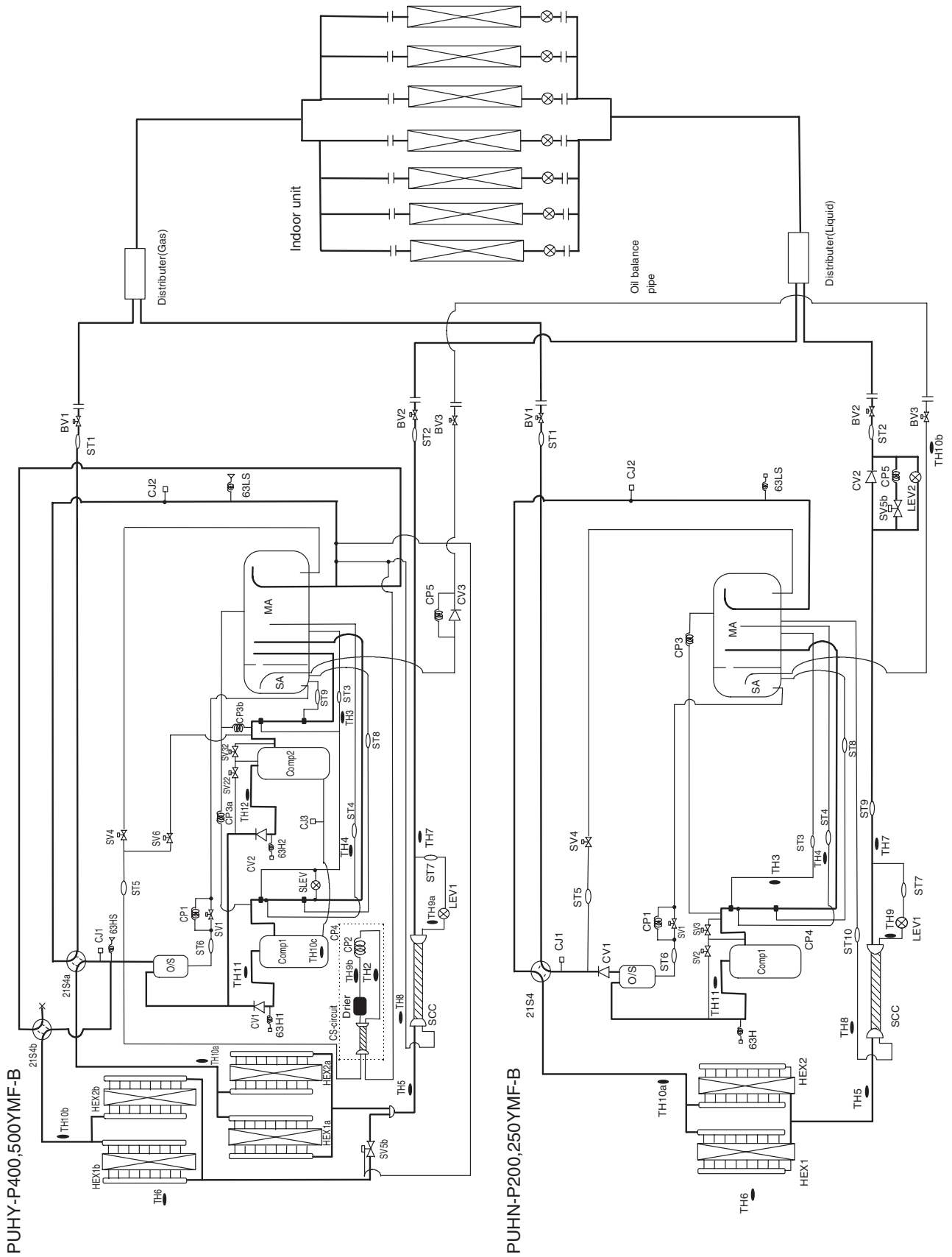

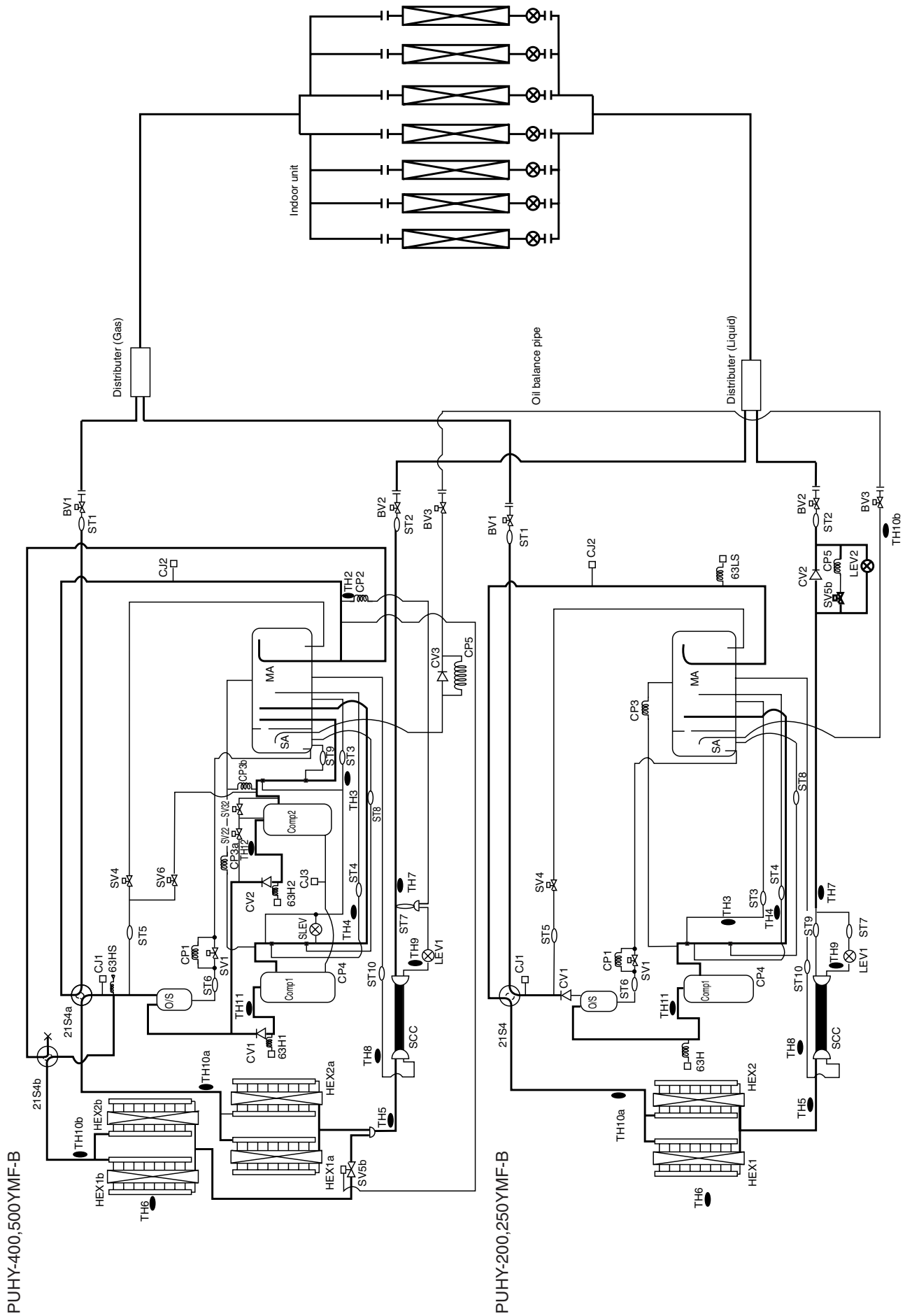

[3] Equipment Composition

A. Outdoor Unit

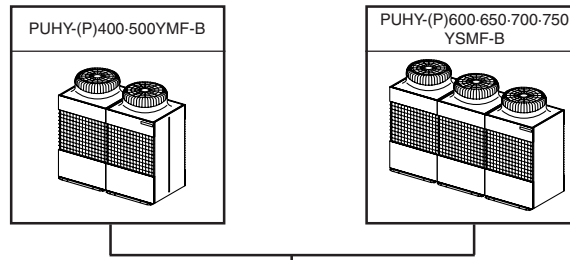

B. Branch Pipe Kit

	Branch joint	Branch header		
		4-connection	7-connection	10-connection
	 CMY-Y102S-F CMY-Y102L-F CMY-Y202-F CMY-Y302-F	 CMY-Y104-E	 CMY-Y107-E	 CMY-Y1010-E

In the case of the PUHY-(P)YSMF-B, the CMC-30A is necessary.

D. Indoor unit

Model	Cassette ceiling			Ceiling concealed	Ceiling mounted built-in	Wall mounted	Ceiling suspended	Floor standing	
	1-way flow	2-way flow	4-way flow					Exposed	Concealed
Capacity	PMFY-P	PLFY-P	PLFY-P	PEFY-P	PDFY-P	PKFY-P	PCFY-P	PFFY-P	PFFY-P
20	20VMB	20VLM	-	20VML	20VM	20VAM	-	20VLEM	20VLRM
25	25VBM	25VLM	-	25VML	25VM	25VAM	-	25VLEM	25VLRM
32	32VBM	32VLM	32VKM	32VML	32VM	32VGM	-	32VLEM	32VLRM
40	40VBM	40VLM	40VKM	40VMH	40VM	40VGM	40VGM	40VLEM	40VLRM
50	-	50VLM	50VKM	50VMH	50VM	50VGM	-	50VLEM	50VLRM
63	-	63VLM	63VKM	63VMH	63VM	-	63VGM	63VLEM	63VLRM
71	-	-	-	71VMH	71VM	-	-	-	-
80	-	80VLM	80VKM	80VMH	80VM	-	-	-	-
100	-	100VLM	100VKM	100VMH	100VM	-	100VGM	-	-
125	-	125VLM	125VKM	125VMH	125VM	-	125VGM	-	-
140	-	-	-	140VMH	-	-	-	-	-
200	-	-	-	200VMH	-	-	-	-	-
250	-	-	-	250VMH	-	-	-	-	-

E. Option (panel)

Model	Decoration panel		
	PMP-	CMP-	PLP-
Capacity			
20	40MB	32LW-F	3GB
25			
32			
40			
50	-	40LW-F	6GB
63		63LW-F	
80		125LW-F	
100, 125			

F. Remote controller

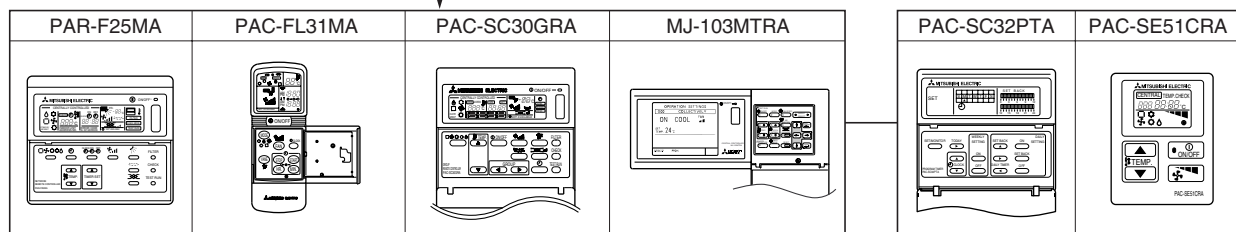

[4] Electrical Wiring Diagram

① PUHY-(P)400-500YMF-B

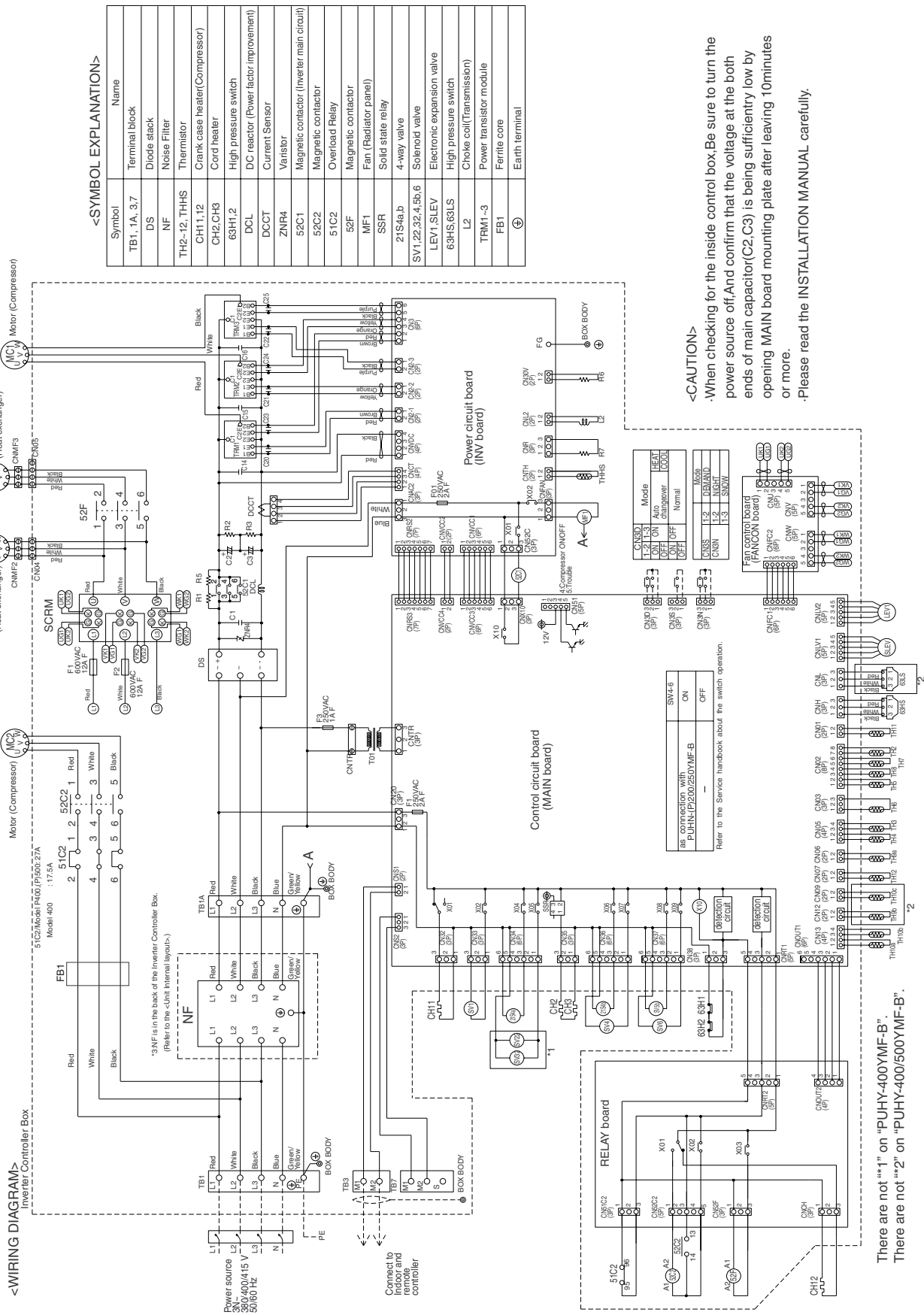

<SYMBOL EXPLANATION>

Symbol	Name
TB1, 1A, 3, 7	Terminal block
DS	Diode stack
NF	Noise Filter
TH2-12, THHS	Thermistor
CH1, 1, 2	Crank case heater(Compressor)
CH2, CH3	Cord heater
63H1, 2	High pressure switch
DCL	DC reactor (Power factor improvement)
DCCT	Current Sensor
ZNR4	Varistor
52C1	Magnetic contactor (Inverter main circuit)
52C2	Magnetic contactor
52F	Magnetic contactor
MF1	Fan (Radiator panel)
SSR	Solid state relay
21S4a, b	4-way valve
SV1, 22, 32, 4, 5b, 6	Solenoid valve
LEV1, 1SLEV	Electronic expansion valve
63HS, 63LS	High pressure switch
L2	Choke coil(Transmission)
TRM1-3	Power transistor module
FB1	Ferrite core
⊕	Earth terminal

<CAUTION>
 -When checking for the inside control box, Be sure to turn the power source off. And confirm that the voltage at the both ends of main capacitor(C2, C3) is being sufficiently low by opening MAIN board mounting plate after leaving 10minutes or more.
 -Please read the INSTALLATION MANUAL carefully.

There are not "1" on "PUHY-400YMF-B".
 There are not "2" on "PUHY-400YMF-B".

<Internal layout>

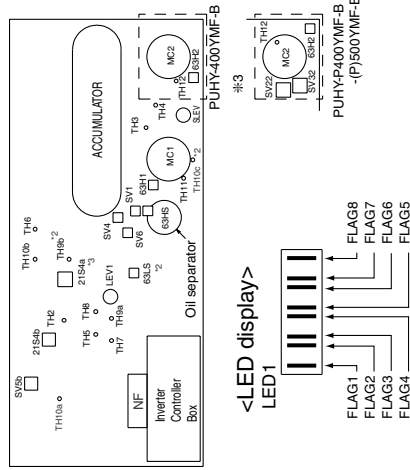

<Operation of self-diagnosis switch (SW1) and LED display>

SW1 operation	Display at LED lighting (blinking)								Remarks
	FLAG1	FLAG2	FLAG3	FLAG4	FLAG5	FLAG6	FLAG7	FLAG8	
 ON: 1 2 3 4 5 6 7 8 9 10 OFF: 0 (at factory shipment)	During compressor run	52C1	52C2	21S4a	SV11	SV22/32	#	Always lighting	FLAG8 always lights at microcomputer power ON #Only for PUHY-P400, (P)500YMF-B
 ON: 1 2 3 4 5 6 7 8 9 10 OFF: 0	Display the address and error code by turns. 51 ← → 1102								SV5B is closed when FLAG3 is turned ON.

* Please refer to the service handbook about other switch settings of LED display.

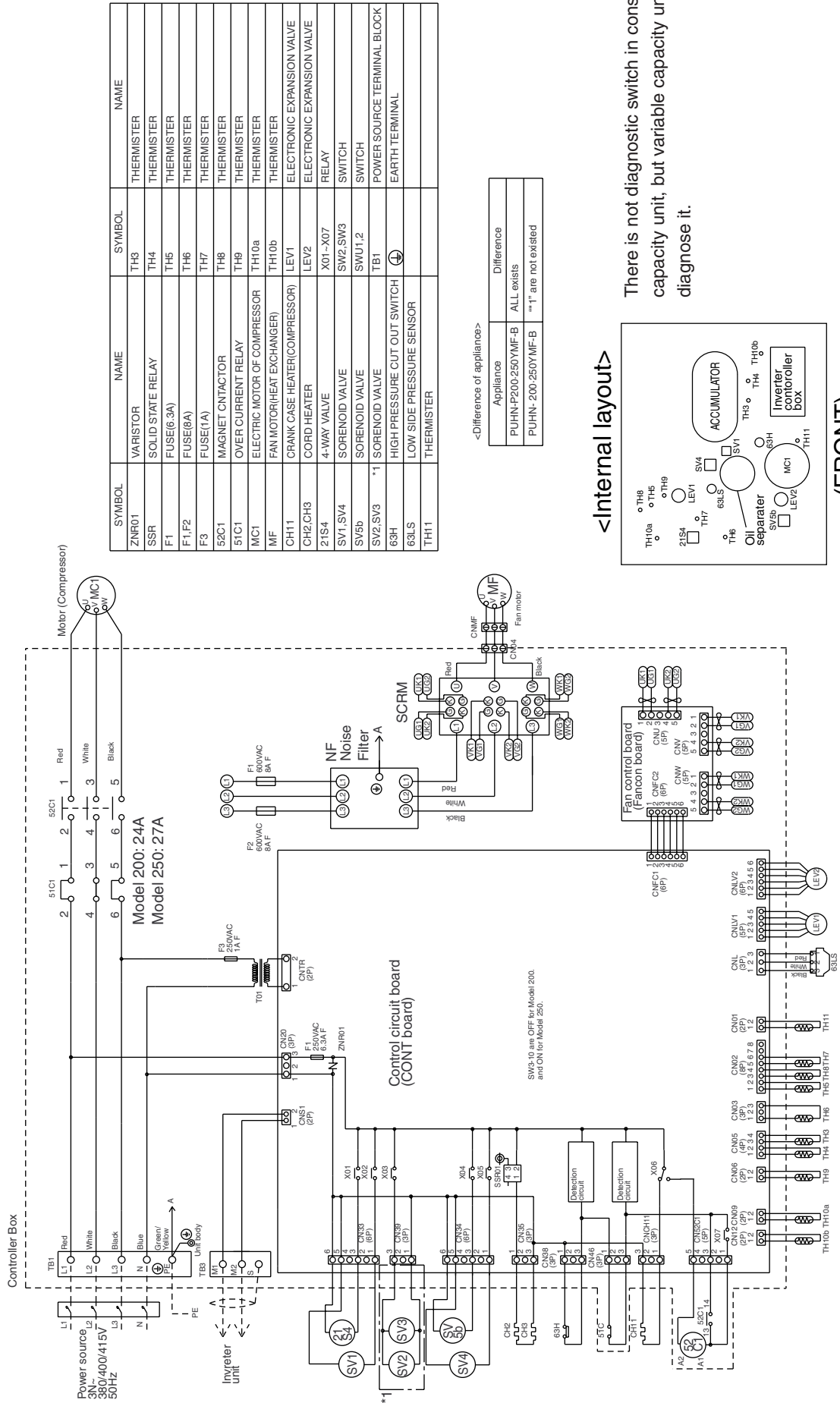

SYMBOL	NAME	SYMBOL	NAME
ZNR01	VARIATOR	TH3	THERMISTER
SSR	SOLID STATE RELAY	TH4	THERMISTER
F1	FUSE(6.3A)	TH5	THERMISTER
F1,F2	FUSE(8A)	TH6	THERMISTER
F3	FUSE(1A)	TH7	THERMISTER
52C1	MAGNET ONTACTOR	TH8	THERMISTER
51C1	OVER CURRENT RELAY	TH9	THERMISTER
MC1	ELECTRIC MOTOR OF COMPRESSOR	TH10a	THERMISTER
MF	FAN MOTOR(HEAT EXCHANGER)	TH10b	THERMISTER
CH11	CRANK CASE HEATER(COMPRESSOR)	LEV1	ELECTRONIC EXPANSION VALVE
CH2,CH3	CORD HEATER	LEV2	ELECTRONIC EXPANSION VALVE
21S4	4-WAY VALVE	X01-X07	RELAY
SV1,SV4	SOLENOID VALVE	SW2,SW3	SWITCH
SV5b	SOLENOID VALVE	SWU1,2	SWITCH
SV2,SV3	*1 SOLENOID VALVE	TB1	POWER SOURCE TERMINAL BLOCK
63H	HIGH PRESSURE CUT OUT SWITCH	⊕	EARTH TERMINAL
63LS	LOW SIDE PRESSURE SENSOR		
TH11	THERMISTER		

<Difference of appliance>

Appliance	Difference
PUHN-P200-250YMF-B	ALL exists
PUHN-200-250YMF-B	**1* are not existed

<Internal layout>

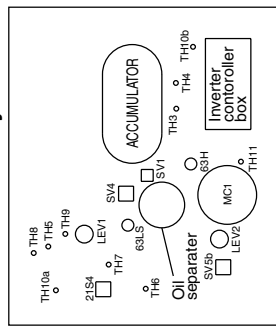

(FRONT)

There is not diagnostic switch in constant capacity unit, but variable capacity unit can diagnose it.

[5] Standard Operation Data

① Cooling operation

Items			Outdoor unit		PUHY-P400YMF-B					PUHY-P500YMF-B				
Condition	Ambient temp.	Indoor	DB/WB	27.0/19.5					27.0/19.5					
		Outdoor		35.0/24.0					35.0/24.0					
	Indoor unit	Quantity	Set	5					5					
		Quantity in operation		5					5					
		Model	-	125	125	100	63	32	125	125	125	100	32	
	Piping	Main pipe	m	5					5					
		Branch pipe		10	10	10	10	10	10	10	10	10	10	
		Total piping length		55					55					
	Indoor unit fan notch		-	Hi	Hi	Hi	Hi	Hi	Hi	Hi	Hi	Hi	Hi	
	Refrigerant volume		kg	22.4					28.9					
Outdoor unit	Total current		A	28.2/26.8/25.8					35.1/33.4/32.2					
	Voltage		V	380 ~ 415					380 ~ 415					
LEV opening	Indoor unit		Pulse	410	410	360	360	340	410	410	410	360	280	
	SC (LEV1)			164					179					
	Oil return (SLEV)			200					344					
Pressure	High pressure/Low pressure (after O/S) (before MA)		kg/cm ² G (MPa)	21.5/4.4 (2.11/0.43)					21.5/4.3 (2.11/0.42)					
Sectional temperature	Outdoor unit	Discharge (TH11/TH12)		°C	92/102					97/102				
		Heat exchanger outlet (TH5)			42									
		Accumulator	Inlet		4					5				
			Outlet		6					7				
		Suction (Comp) (No.1/No.2)			6/12					12/12				
		Low pressure saturation temperature (TH2)			1									
		Liquid level	Upper (TH4)		30									
			Lower (TH3)		1									
		Shell bottom (Comp No.1/No.2)			60/51					65/50				
		SCC outlet (TH7)			27									
		Bypass outlet (TH8)			10					11				
		Bypass inlet (TH9a)			2					3				
		CS circuit (TH9b)			16									
		Circulating configuration (αOC)			0.23									
		Indoor unit	LEV inlet		26									
Heat exchanger outlet			12											

Items		Outdoor unit		-	PUHY-P600YSMF-B	PUHY-P700YSMF-B	
				Variable capacity unit	PUHY-P400YMF-B	PUHY-P500YMF-B	
				Constant capacity unit	PUHN-P200YMF-B	PUHN-P200YMF-B	
Condition	Ambient temp.	Indoor	DB/WB	27/19.5			
		Outdoor		35/-			
	Indoor unit	Quantity	Set	5			
		Quantity in operation		5			
		Model	-	200/200/125/50/25	250/200/125/100/25		
	Piping	Main pipe	m	5			
		Branch pipe		5			
		Total piping length		30			
	Indoor unit fan notch		-	Hi			
	Refrigerant volume		kg	28.9	35.9		
Outdoor unit	Current		A	42.5/40.4/38.9	50.3/47.8/46.1		
	Voltage		V	380 ~ 415			
LEV opening	Indoor unit		Pulse	360/360/410/360/270		410/360/410/360/270	
	Variable capacity	SC (LEV1)		164	179		
		Oil return (SLEV)		200	344		
	Constant capacity	SC (LEV1)		116			
		Liquid pipe (LEV2)		60			
Pressure	High pressure/Low pressure (after O/S) (before Main ACC)		kg/cm ² G (MPa)	21.5/4.6 (2.11/0.45)	21.5/4.5 (2.11/0.44)		
	Sectional temperature	Variable capacity unit	Discharge (TH11/TH12)		92/102	97/102	
Heat exchanger outlet (TH5)			42				
Accumulator			Inlet	6	5		
			Outlet	8	7		
Suction (Comp)			7/13	13/13			
Low pressure saturation temperature (TH2)			2	1			
Liquid level			Upper (TH4)	30			
			Lower (TH3)	2	1		
Shell bottom (Comp)			60/51	65/50			
SCC outlet (TH7)			27				
Bypass outlet (TH8)			11	10			
Bypass inlet (TH9a)			3	2			
CS circuit (TH9b)			16				
Circulating configuration (αOC)			0.23				
Constant capacity unit			Discharge temperature (TH11)		102		
		Liquid level	Upper (TH4)	30			
			Lower (TH3)	4			
	Shell bottom (Comp)		50				
	SCC outlet (TH7)		27				
	Bypass outlet (TH8)		13				
Bypass inlet (TH9)		5					
Indoor unit	LEV inlet		26				
	Heat exchanger outlet		12				

Items		Outdoor unit		-	PUHY-P650YSMF-B	PUHY-P750YSMF-B		
				Variable capacity unit	PUHY-P400YMF-B	PUHY-P500YMF-B		
				Constant capacity unit	PUHN-P250YMF-B	PUHN-P250YMF-B		
Condition	Ambient temp.	Indoor	DB/WB	27/19.5				
		Outdoor		35/-				
	Indoor unit	Quantity	Set	5				
		Quantity in operation		5				
		Model	-	250/200/125/50/25	250/250/125/100/25			
	Piping	Main pipe	m	5				
		Branch pipe		5				
Total piping length		30						
Indoor unit fan notch		-	Hi					
Refrigerant volume		kg	31.9	37.9				
Outdoor unit	Current		A	45.8/43.5/41.9	53.5/50.8/48.9			
	Voltage		V	380 ~ 415				
LEV opening	Indoor unit		Pulse	410/360/410/360/270		410/410/410/360/270		
	Variable capacity	SC (LEV1)		164		179		
		Oil return (SLEV)		200		344		
	Constant capacity	SC (LEV1)		116				
		Liquid pipe (LEV2)		60				
Pres- sure	High pressure/Low pressure (after O/S) (before Main ACC)		kg/cm ² G (MPa)	21.5/4.6 (2.11/0.45)	21.5/4.5 (2.11/0.44)			
	Sectional temperature	Discharge (TH11/TH12)		°C	92/102		97/102	
Heat exchanger outlet (TH5)		42						
Accumulator		Inlet	6		5			
		Outlet	8		7			
Suction (Comp)		7/13			13/13			
Low pressure saturation temperature (TH2)		2			1			
Liquid level		Upper (TH4)	30					
		Lower (TH3)	2		1			
Shell bottom (Comp)		60/51			65/50			
SCC outlet (TH7)		27						
Bypass outlet (TH8)		11			10			
Bypass inlet (TH9a)		3			2			
CS circuit (TH9b)		16						
Circulating configuration (αOC)		0.23						
Constant capacity unit		Discharge temperature (TH11)			102			
		Liquid level	Upper (TH4)		30			
			Lower (TH3)		3			
	Shell bottom (Comp)		50					
	SCC outlet (TH7)		27					
	Bypass outlet (TH8)		12					
	Bypass inlet (TH9)		4					
Indoor unit	LEV inlet		26					
	Heat exchanger outlet		12					

Items			Outdoor unit	PUHY-400YMF-B					PUHY-500YMF-B					
Condition	Ambient temp.	Indoor	DB/WB	27.0/19.5					27.0/19.5					
		Outdoor		35.0/24.0					35.0/24.0					
	Indoor unit	Quantity		Set	5					5				
		Quantity in operation			5					5				
		Model		-	125	125	100	63	32	125	125	125	100	32
	Piping	Main pipe		m	5					5				
		Branch pipe			10	10	10	10	10	10	10	10	10	10
		Total piping length			55					55				
	Indoor unit fan notch			-	Hi	Hi	Hi	Hi	Hi	Hi	Hi	Hi	Hi	Hi
	Refrigerant volume			kg	22.4					28.9				
Outdoor unit	Total current		A	28.2/26.8/25.8					34.2/32.5/31.3					
	Voltage		V	380 ~ 415					380 ~ 415					
LEV opening	Indoor unit		Pulse	430	430	380	380	350	430	430	430	380	290	
	SC (LEV1)			164					179					
	Oil return (SLEV)			344										
Pressure	High pressure/Low pressure (after O/S) (before MA)		kg/cm ² G (MPa)	20.0/4.4 (1.96/0.43)					20.0/4.3 (1.96/0.42)					
Sectional temperature	Outdoor unit	Discharge (TH11/TH12)		°C	90/95					95/100				
		Heat exchanger outlet (TH5)			42									
		Accumulator	Inlet		2					3				
			Outlet		4					5				
		Suction (Comp) (No.1/No.2)			4/10					10/10				
		Low pressure saturation temperature (TH2)			3									
		Liquid level	Upper (TH4)		30									
			Lower (TH3)		3									
		Shell bottom (Comp No.1/No.2)			60/51					65/50				
		SCC outlet (TH7)			27									
		Bypass outlet (TH8)			8					9				
		Bypass inlet (TH9)			4					5				
	Indoor unit	LEV inlet			26									
Heat exchanger outlet		10												

Items		Outdoor unit		-	PUHY-600YSMF-B	PUHY-700YSMF-B
				Variable capacity unit	PUHY-400YMF-B	PUHY-500YMF-B
				Constant capacity unit	PUHN-200YMF-B	PUHN-200YMF-B
Condition	Ambient temp.	Indoor	DB/WB	27/19.5		
		Outdoor		35/-		
	Indoor unit	Quantity	Set	5		
		Quantity in operation		5		
		Model	-	200/200/125/50/25	250/200/125/100/25	
	Piping	Main pipe	m	5		
		Branch pipe		5		
		Total piping length		30		
Indoor unit fan notch		-	Hi			
Refrigerant volume		kg	28.9	35.9		
Outdoor unit	Current		A	41.4/39.4/37.9	48.3/45.8/44.2	
	Voltage		V	380 ~ 415		
LEV opening	Indoor unit		Pulse	380/380/430/380/280	430/380/430/380/280	
	Variable capacity	SC (LEV1)		164	179	
		Oil return (SLEV)		344		
	Constant capacity	SC (LEV1)		116		
		Liquid pipe (LEV2)		60		
Pres- sure	High pressure/Low pressure (after O/S) (before Main ACC)		kg/cm ² G (MPa)	20/4.6 (1.96/0.45)	20/4.5 (1.96/0.44)	
Sectional temperature	Variable capacity unit	Discharge (TH11/TH12)		90/95	95/100	
		Heat exchanger outlet (TH5)		42		
		Accumulator	Inlet	4	3	
			Outlet	6	5	
		Suction (Comp)		5/11	11/11	
		Low pressure saturation temperature (TH2)		4	3	
		Liquid level	Upper (TH4)	30		
			Lower (TH3)	4	3	
		Shell bottom (Comp)		60/51	65/50	
		SCC outlet (TH7)		27		
		Bypass outlet (TH8)		9	8	
		Bypass inlet (TH9)		5	4	
	Constant capacity unit	Discharge temperature (TH11)		100		
		Liquid level	Upper (TH4)	30		
			Lower (TH3)	6		
		Shell bottom (Comp)		50		
		SCC outlet (TH7)		27		
		Bypass outlet (TH8)		11		
		Bypass inlet (TH9)		7		
	Indoor unit	LEV inlet		26		
Heat exchanger outlet		10				

Items		Outdoor unit		-	PUHY-650YSMF-B	PUHY-750YSMF-B
				Variable capacity unit	PUHY-400YMF-B	PUHY-500YMF-B
				Constant capacity unit	PUHN-250YMF-B	PUHN-250YMF-B
Condition	Ambient temp.	Indoor	DB/WB	27/19.5		
		Outdoor		35/-		
	Indoor unit	Quantity	Set	5		
		Quantity in operation		5		
		Model	-	250/200/125/50/25	250/250/125/100/25	
	Piping	Main pipe	m	5		
		Branch pipe		5		
		Total piping length		30		
	Indoor unit fan notch		-	Hi		
	Refrigerant volume		kg	31.9	37.9	
Outdoor unit	Current		A	44.6/42.4/40.8	51.4/48.8/47.1	
	Voltage		V	380 ~ 415		
LEV opening	Indoor unit		Pulse	430/380/430/380/280	430/430/430/380/280	
	Variable capacity	SC (LEV1)		164	179	
		Oil return (SLEV)		344		
	Constant capacity	SC (LEV1)		116		
		Liquid pipe (LEV2)		60		
Pressure	High pressure/Low pressure (after O/S) (before Main ACC)		kg/cm ² G (MPa)	20/4.6 (1.96/0.45)	20/4.5 (1.96/0.44)	
	Sectional temperature	Variable capacity unit	Discharge (TH11/TH12)		90/95	95/100
Heat exchanger outlet (TH5)			42			
Accumulator			Inlet	4	3	
			Outlet	6	5	
Suction (Comp)			5/11	11/11		
Low pressure saturation temperature (TH2)			4	3		
Liquid level			Upper (TH4)	30		
			Lower (TH3)	4	3	
Shell bottom (Comp)			60/51	65/50		
SCC outlet (TH7)			27			
Bypass outlet (TH8)		9	8			
Bypass inlet (TH9)		5	4			
Constant capacity unit		Discharge temperature (TH11)		100		
		Liquid level	Upper (TH4)	30		
			Lower (TH3)	5		
	Shell bottom (Comp)		50			
	SCC outlet (TH7)		27			
	Bypass outlet (TH8)		10			
	Bypass inlet (TH9)		6			
Indoor unit	LEV inlet		26			
	Heat exchanger outlet		10			

② Heating operation

Items			Outdoor unit	PUHY-P400YMF-B					PUHY-P500YMF-B					
Condition	Ambient temp.	Indoor	DB/WB	21.0/-					21.0/-					
		Outdoor		7.0/6.0					7.0/6.0					
	Indoor unit	Quantity	Set	5					5					
		Quantity in operation		5					5					
		Model	-	125	125	100	63	32	125	125	125	100	32	
	Piping	Main pipe	m	5					5					
		Branch pipe		10	10	10	10	10	10	10	10	10	10	
		Total piping length		55					55					
	Indoor unit fan notch			-	Hi	Hi	Hi	Hi	Hi	Hi	Hi	Hi	Hi	Hi
	Refrigerant volume			kg	22.4					28.7				
Outdoor unit	Total current			A	26.5/25.2/24.3					32.8/31.1/30.0				
	Voltage			V	380 ~ 415					380 ~ 415				
LEV opening	Indoor unit			Pulse	420	420	330	490	320	420	420	420	330	320
	SC (LEV1)				0									
	Oil return (SLEV)				122									
Pressure	High pressure/Low pressure (after O/S) (before MA)			kg/cm ² G (MPa)	21.5/3.6 (2.11/0.35)					21.5/3.2 (2.11/0.31)				
Sectional temperature	Outdoor unit	Discharge (TH11/TH12)		°C	88/93					88/93				
		Heat exchanger inlet (TH5)			- 3					- 1				
		Accumulator	Inlet		- 6					- 7				
			Outlet		- 6					- 7				
		Suction (Comp) (No.1/No.2)			- 5/2					- 5/0				
		Low pressure saturation temperature (TH2)			- 10									
		Liquid level	Upper (TH4)		30									
			Lower (TH3)		- 6									
		Shell bottom (Comp No.1/No.2)			43/45					40/33				
		CS circuit (TH9b)			5									
		Heat exchanger gas line (TH10a/TH10b)			- 6/- 6					- 7/- 7				
		Circulating configuration (αOC)			0.28									
	Indoor unit	Heat exchanger inlet		81										
LEV inlet		34												

Items		Outdoor unit		-	PUHY-P600YSMF-B	PUHY-P700YSMF-B	
				Variable capacity unit	PUHY-P400YMF-B	PUHY-P500YMF-B	
				Constant capacity unit	PUHN-P200YMF-B	PUHN-P200YMF-B	
Condition	Ambient temp.	Indoor	DB/WB	21/-			
		Outdoor		7/6			
	Indoor unit	Quantity	Set	5			
		Quantity in operation		5			
		Model	-	200/200/125/50/25	250/200/125/100/25		
	Piping	Main pipe	m	5			
		Branch pipe		5			
		Total piping length		30			
	Indoor unit fan notch		-	Hi			
Refrigerant volume		kg	28.9	35.9			
Outdoor unit	Current		A	38.3/36.4/35.0	44.9/42.7/41.2		
	Voltage		V	380 ~ 415			
LEV opening	Indoor unit		Pulse	330/330/420/430/270	420/330/420/330/270		
	Variable capacity	SC (LEV1)		0			
		Oil return (SLEV)		122	198		
	Constant capacity	SC (LEV1)		0			
		Liquid pipe (LEV2)		500			
Pres- sure	High pressure/Low pressure (after O/S) (before Main ACC)		kg/cm ² G (MPa)	21.5/3.5 (2.11/0.34)	21.5/3.5 (2.11/0.34)		
	Sectional temperature	Discharge (TH11/TH12)		°C	88/93		
Heat exchanger outlet (TH5)		- 3	- 1				
Variable capacity unit		Accumulator	Inlet		- 5	- 6	
			Outlet		- 5	- 6	
Suction (Comp)		- 5/2	- 6/0				
Low pressure saturation temperature (TH2)		- 9	- 10				
Liquid level		Upper (TH4)	30				
		Lower (TH3)	- 5		- 6		
Shell bottom (Comp)		43/45	40/33				
CS circuit (TH9b)		5					
Heat exchanger gas line (TH10a/TH10b)		- 5/- 5	- 6/- 6				
Circulating configuration (αOC)		0.28					
Constant capacity unit		Discharge temperature (TH11)			93		
		Suction (Comp)			1		
		Liquid level	Upper (TH4)		30		
	Lower (TH3)		- 5				
	Shell bottom (Comp)		33				
Heat exchanger gas line (TH10a)		- 1					
Indoor unit	Heat exchanger inlet		81				
	LEV inlet		34				

Items		Outdoor unit		-	PUHY-P650YSMF-B	PUHY-P750YSMF-B	
				Variable capacity unit	PUHY-P400YMF-B	PUHY-P500YMF-B	
				Constant capacity unit	PUHN-P250YMF-B	PUHN-P250YMF-B	
Condition	Ambient temp.	Indoor	DB/WB	21/-			
		Outdoor		7/6			
	Indoor unit	Quantity	Set	5			
		Quantity in operation		5			
		Model	-	250/200/125/50/25	250/250/125/100/25		
	Piping	Main pipe	m	5			
		Branch pipe		5			
Total piping length		30					
Indoor unit fan notch		-	Hi				
Refrigerant volume		kg	31.9	37.9			
Outdoor unit	Current		A	42.0/39.9/38.5	48.3/45.9/44.2		
	Voltage		V	380 ~ 415			
LEV opening	Indoor unit		Pulse	420/330/420/430/270	420/420/420/330/270		
	Variable capacity	SC (LEV1)		0			
		Oil return (SLEV)		122	198		
	Constant capacity	SC (LEV1)		0			
		Liquid pipe (LEV2)		800			
Pres- sure	High pressure/Low pressure (after O/S) (before Main ACC)		kg/cm ² G (MPa)	21.5/3.5 (2.11/0.34)	21.5/3.5 (2.11/0.34)		
	Sectional temperature	Discharge (TH11/TH12)		°C	88/93		
Heat exchanger outlet (TH5)		- 3	- 1				
Accumulator		Inlet	- 5		- 6		
		Outlet	- 5		- 6		
Suction (Comp)		- 5/2	- 6/0				
Low pressure saturation temperature (TH2)		- 9	- 10				
Liquid level		Upper (TH4)	30				
		Lower (TH3)	- 5		- 6		
Shell bottom (Comp)		43/45	40/33				
CS circuit (TH9b)		5					
Heat exchanger gas line (TH10a/TH10b)		- 5/- 5	- 6/- 6				
Circulating configuration (αOC)		0.28					
Constant capacity unit		Discharge temperature (TH11)			93		
		Suction (Comp) (No.1/No.2)			0		
	Liquid level	Upper (TH4)	30				
		Lower (TH3)	- 6				
	Shell bottom (Comp)		33				
	Heat exchanger gas line (TH10a)		- 2				
Indoor unit	Heat exchanger inlet		81				
	LEV inlet		34				

Items		Outdoor unit		PUHY-400YMF-B					PUHY-500YMF-B					
Condition	Ambient temp.	Indoor	DB/WB	21.0/-					21.0/-					
		Outdoor		7.0/6.0					7.0/6.0					
	Indoor unit	Quantity		Set	5					5				
		Quantity in operation			5					5				
		Model			-	125	125	100	63	32	125	125	125	100
	Piping	Main pipe		m	5					5				
		Branch pipe			10	10	10	10	10	10	10	10	10	10
		Total piping length			55					55				
	Indoor unit fan notch			-	Hi	Hi	Hi	Hi	Hi	Hi	Hi	Hi	Hi	Hi
	Refrigerant volume			kg	22.4					28.7				
Outdoor unit	Total current		A	26.0/24.7/23.8					32.2/30.6/29.5					
	Voltage		V	380 ~ 415					380 ~ 415					
LEV opening	Indoor unit		Pulse	420	420	330	490	320	420	420	420	330	320	
	SC (LEV1)			0					0					
	Oil return (SLEV)			122										
Pressure	High pressure/Low pressure (after O/S) (before MA)		kg/cm ² G (MPa)	18.0/3.6 (1.77/0.35)					18.0/3.2 (1.77/0.31)					
Sectional temperature	Outdoor unit	Discharge (TH11/TH12)		°C	85/90					85/90				
		Heat exchanger inlet (TH5)			7					9				
		Accumulator	Inlet		- 4					- 5				
			Outlet		- 4					- 5				
		Suction (Comp) (No.1/No.2)			- 3/4					- 3/2				
		Low pressure saturation temperature (TH2)			- 4									
		Liquid level	Upper (TH4)		30									
			Lower (TH3)		- 4									
		Shell bottom (Comp No.1/No.2)			43/45					40/33				
		Heat exchanger gas line (TH10a/TH10b)			- 4/- 4					- 5/- 5				
	Indoor unit	Heat exchanger inlet			78									
LEV inlet		37												

Items		Outdoor unit		-	PUHY-600YSMF-B	PUHY-700YSMF-B	
				Variable capacity unit	PUHY-400YMF-B	PUHY-500YMF-B	
				Constant capacity unit	PUHN-200YMF-B	PUHN-200YMF-B	
Condition	Ambient temp.	Indoor	DB/WB	21/-			
		Outdoor		7/6			
	Indoor unit	Quantity	Set	5			
		Quantity in operation		5			
		Model	-	200/200/125/50/25	250/200/125/100/25		
	Piping	Main pipe	m	5			
		Branch pipe		5			
		Total piping length		30			
Indoor unit fan notch		-	Hi				
Refrigerant volume		kg	28.9	35.9			
Outdoor unit	Current		A	37.9/36.0/34.7	44.4/42.1/40.6		
	Voltage		V	380 ~ 415			
LEV opening	Indoor unit		Pulse	350/350/440/450/280	440/350/440/350/280		
	Variable capacity	SC (LEV1)		0			
		Oil return (SLEV)		198			
	Constant capacity	SC (LEV1)		100			
		Liquid pipe (LEV2)		500			
Pres- sure	High pressure/Low pressure (after O/S) (before Main ACC)		kg/cm ² G (MPa)	18/3.5 (1.76/0.34)	18/3.5 (1.76/0.34)		
	Sectional temperature	Discharge (TH11/TH12)		°C	85/90		
Heat exchanger outlet (TH5)		7	9				
Accumulator		Inlet	- 3		- 4		
		Outlet	- 3		- 4		
Suction (Comp)		- 3/4	- 4/2				
Low pressure saturation temperature (TH2)		- 3	- 4				
Liquid level		Upper (TH4)	30				
		Lower (TH3)	- 3		- 4		
Shell bottom (Comp)		43/45	40/33				
Heat exchanger gas line (TH10a/TH10b)		- 3/- 3	- 4/- 4				
Variable capacity unit		Discharge temperature (TH11)			90		
		Suction (Comp)			3		
		Liquid level	Upper (TH4)		30		
			Lower (TH3)		- 3		
	Shell bottom (Comp)		33				
	Bypass inlet (TH9)		- 3				
	Heat exchanger gas line (TH10a)		- 3				
Indoor unit	Heat exchanger inlet		78				
	LEV inlet		37				

Items		Outdoor unit		-	PUHY-650YSMF-B	PUHY-750YSMF-B	
				Variable capacity unit	PUHY-400YMF-B	PUHY-500YMF-B	
				Constant capacity unit	PUHN-250YMF-B	PUHN-250YMF-B	
Condition	Ambient temp.	Indoor	DB/WB	21/-			
		Outdoor		7/6			
	Indoor unit	Quantity	Set	5			
		Quantity in operation		5			
		Model	-	250/200/125/50/25	250/250/125/100/25		
	Piping	Main pipe	m	5			
		Branch pipe		5			
		Total piping length		30			
	Indoor unit fan notch		-	Hi			
Refrigerant volume		kg	31.9	37.9			
Outdoor unit	Current		A	41.2/39.1/37.7	47.7/45.3/43.7		
	Voltage		V	380 ~ 415			
LEV opening	Indoor unit		Pulse	440/350/440/450/280	440/440/440/350/280		
	Variable capacity	SC (LEV1)		0			
		Oil return (SLEV)		198			
	Constant capacity	SC (LEV1)		100			
		Liquid pipe (LEV2)		800			
Pres- sure	High pressure/Low pressure (after O/S) (before Main ACC)		kg/cm ² G (MPa)	18/3.5 (1.76/0.34)	18/3.5 (1.76/0.34)		
	Sectional temperature	Discharge (TH11/TH12)		°C	85/90		
Heat exchanger outlet (TH5)		7	9				
Accumulator		Inlet	- 3		- 4		
		Outlet	- 3		- 4		
Suction (Comp)		- 3/4	- 4/2				
Low pressure saturation temperature (TH2)		- 3	- 4				
Liquid level		Upper (TH4)	30				
		Lower (TH3)	- 3		- 4		
Shell bottom (Comp)		43/45	40/33				
Heat exchanger gas line (TH10a/TH10b)		- 3/- 3	- 4/- 4				
Variable capacity unit		Discharge temperature (TH11)			90		
		Suction (Comp) (No.1/No.2)			2		
		Liquid level	Upper (TH4)		30		
			Lower (TH3)		- 4		
	Shell bottom (Comp)		33				
	Bypass inlet (TH9)		- 4				
	Heat exchanger gas line (TH10a)		- 4				
Indoor unit	Heat exchanger inlet		78				
	LEV inlet		37				

[6] Function of Dip SW and Rotary SW

(1) Outdoor unit

PUHY-P600-650-700-750YSMF-B.

PUHY-P400-500YMF-B.

① Variable capacity unit

MAIN board

Switch	Function	Function According to Switch Operation		Switch Set Timing		
		When Off	When On	When Off	When On	
SWU	1 ~ 2	Unit Address Setting		Set on 51 ~ 100 with the rotary switch.*2		Before power is turned on.
SW1	1 ~ 8	For self diagnosis/operation monitoring				Refer to LED monitor display on the outdoor board.
	9 ~ 10	-				-
SW2	1	Centralized Control Switch	Centralized control not connected.	Centralized control connected.	Before power is turned on.	
	2	Deletion of connection information.	Storing of refrigeration system connection information.	Deletion of refrigeration system connection information.	Before power is turned on.	
	3	Deletion of error history.	Store IC•OC error history.	Erase IC•OC error history.	During normal operation when power is on.	
	4	• Adjustment of Refrigerant Volume • Ignore liquid level errors	Ordinary control	• Refrigerant volume adjustment operation. • Ignore liquid level errors	During normal operation when power is on.	Invalid 2 hours after compressor starts.
	5	-	-	-	-	
	6	-	-	-	-	
	7	Forced defrosting	Ordinary control	Start forced defrosting.	During normal operation when power is on.	10 minutes or more after compressor starts.
	8	-	-	-	-	
	9	-	-	-	-	
	10	Reset of the time the CS circuit is closed.	When the CS circuit is closed, that time is totaled.	Timer Reset	During normal operation when power is on.	
SW3	1	SW3-2 Function Valid/Invalid	SW3-2 Function Invalid	SW3-2 Function Valid	During normal operation when power is on.	
	2	Indoor Unit Test Operation	Stop all indoor units.	All indoor units test run ON.	When SW3-1 is ON after power is turned on.	
	3	Defrosting start temperature .	- 8°C	- 10°C	During normal operation when power is on.	
	4	Defrosting end temperature.	7°C	12°C	During normal operation when power is on. (Except during defrosting)	
	5	Target low-pressure change	Ordinary control	Evaporation temperature / 2°C lower than normal	During normal operation when power is on.	
	6	Pump Down Function	Ordinary control	Pump Down Operation	While the compressor is stopped.	
	7	Target high-pressure change	Ordinary control	High pressure / 1.5 ~ 2.5 K higher than normal	During normal operation when power is on.	
	8	-	-	-	-	
	9	-	-	-	-	
	10	Models	Model 400	Model 500	When switching on the power.	
SW4	1	SW4-3 Function valid/Invalid	SW4-3 Function invalid	SW4-3 Function valid	When switching on the power.	
	2	Change service LED	Display variable capacity unit operations.	Display constant capacity unit operations.	During normal operation when power is on.	
	3	Configuration compensation value	Changes as shown below by on → off change 0 %→3 %→6 %→9 %→12 %→ - 6 %→ - 3 %→0 %		When SW4-1 is ON	
	4	-	-	-	-	
	5	Inverter control	2-phase modulation	3-phase modulation	When switching on the power.	
	6	Switch Models	Y Setting	Super Y Setting	Before power is turned on.	
	7	-	-	-	-	
	8	-	-	-	-	
	9	-	-	-	-	
	10	-	-	-	-	

Note 1: Factory setting is SWU 1 to 2 = 00, SW3 - 10 = set by model. All other switches are set to OFF.

Note 2: If the address is set from 01 to 50, it automatically becomes 100.

Note 3: Factory settings are SW4-6 = OFF, setting = Y.

When operating in Super Y mode, turn SW4-6 ON.

② Constant Capacity Unit

Switch	Function	Function According to Switch Operation		Switch Set Timing	
		When Off	When On	When Off	When On
SWU	1 ~ 2	Unit Address Setting		Set on 51 ~ 100 with the rotary switch.*2	
				Before power is turned on.	
SW2	1	-	-	-	-
	2	-	-	-	-
	3	-	-	-	-
	4	Ignore liquid level errors	Ordinary control	Ignore liquid level errors	During normal operation when power is on.
	5	-	-	-	-
	6	-	-	-	-
	7	Forced defrosting	Ordinary control	Start forced defrosting.	During normal operation when power is on. Invalid 2 hours after compressor starts.
	8	-	-	-	-
	9	-	-	-	-
	10	-	-	-	-
SW3	1	-	-	-	-
	2	-	-	-	-
	3	Defrosting start temperature.	- 8°C	- 10°C	During normal operation when power is on.
	4	Defrosting end temperature.	7°C	12°C	During normal operation when power is on. (Except during defrosting)
	5	Ignore oil-equalization circuit irregularities	Ordinary control	Ignore oil-equalization circuit irregularities	During normal operation when power is on.
	6	-	-	-	-
	7	-	-	-	-
	8	-	-	-	-
	9	Models (Refrigerant)	R22 Model	R407C Model	Before power is turned on.
	10	Models (Capacity)	Model 200	Model 250	When switching on the power.

Note 1: Factory setting is SWU 1 to 2 = 00, SW3 - 10 = set by model. All other switches are set to OFF.

Note 2: If the address is set from 01 to 50, it automatically becomes 100.

PUHY-600-650-700-750 YSMF-B.

PUHY-400-500YMF-B.

① Variable capacity unit

MAIN board

Switch	Function	Function According to Switch Operation		Switch Set Timing		
		When Off	When On	When Off	When On	
SWU	1 ~ 2	Unit Address Setting	Set on 51 ~ 100 with the rotary switch.*2		Before power is turned on.	
SW1	1 ~ 8	For self diagnosis/ operation monitoring	Refer to LED monitor display on the outdoor board.			
	9 ~ 10	-	-	-	-	
SW2	1	Centralized Control Switch	Centralized control not connected.	Centralized control connected.	Before power is turned on.	
	2	Deletion of connection information.	Storing of refrigeration system connection information.	Deletion of refrigeration system connection information.	Before power is turned on.	
	3	Deletion of error history.	Store IC•OC error history.	Erase IC•OC error history.	During normal operation when power is on.	
	4	• Adjustment of Refrigerant Volume • Ignore liquid level errors	Ordinary control	• Refrigerant volume adjustment operation. • Ignore liquid level errors	During normal operation when power is on.	Invalid 2 hours after compressor starts.
	5	-	-	-	-	
	6	-	-	-	-	
	7	Forced defrosting	Ordinary control	Start forced defrosting.	During normal operation when power is on.	10 minutes or more after compressor starts.
	8	-	-	-	-	
	9	-	-	-	-	
	10	Preserve suction pressure	Valid during normal operation	note: 3	During normal operation when power is on.	
SW3	1	SW3-2 Function Valid/ Invalid	SW3-2 Function Invalid	SW3-2 Function Valid	During normal operation when power is on.	
	2	Indoor Unit Test Operation	Stop all indoor units.	All indoor units test run ON.	When SW3-1 is ON after power is turned on.	
	3	Defrosting start temperature .	0°C	- 2°C	During normal operation when power is on.	
	4	Defrosting end temperature.	7°C	12°C	During normal operation when power is on. (Except during defrosting)	
	5	Target low-pressure change	Ordinary control	Evaporation temperature / 2°C lower than normal	During normal operation when power is on.	
	6	-	-	-	-	
	7	Target high-pressure change	Ordinary control	High pressure / 1.5 ~ 2.5 K higher than normal	During normal operation when power is on.	
	8	-	-	-	-	
	9	-	-	-	-	
	10	Models	Model 400	Model 500	When switching on the power.	
SW4	1	-	-	-	-	
	2	Change service LED	Display variable capacity unit operations.	Display constant capacity unit operations.	During normal operation when power is on.	
	3	-	-	-	When SW4-1 is ON	
	4	-	-	-	-	
	5	Inverter control	2-phase modulation	3-phase modulation	When switching on the power.	
	6	Switch Models	Y Setting	Super Y Setting	Before power is turned on.	
	7	-	-	-	-	
	8	-	-	-	-	
	9	-	-	-	-	
	10	-	-	-	-	

Note 1: Factory setting is SWU 1 to 2 = 00, SW3 - 10 = set by model. All other switches are set to OFF.

Note 2: If the address is set from 01 to 50, it automatically becomes 100.

Note 3: The operation cumulative time of compressor is effective to it only within 1 hour.

Note 4: Factory settings are SW4-6 = OFF, setting = Y.

When operating in Super Y mode, turn SW4-6 ON.

② Constant Capacity Unit

Switch	Function	Function According to Switch Operation		Switch Set Timing		
		When Off	When On	When Off	When On	
SWU	1 ~ 2 Unit Address Setting	Set on 51 ~ 100 with the rotary switch.*2		Before power is turned on.		
SW2	1	-	-	-	-	
	2	-	-	-	-	
	3	-	-	-	-	
	4	Ignore liquid level errors	Ordinary control	Ignore liquid level errors	During normal operation when power is on.	
	5	-	-	-	-	
	6	-	-	-	-	
	7	Forced defrosting	Ordinary control	Start forced defrosting.	During normal operation when power is on.	Invalid 2 hours after compressor starts.
	8	-	-	-	-	
	9	-	-	-	-	
	10	-	-	-	-	
SW3	1	-	-	-	-	
	2	-	-	-	-	
	3	Defrosting start temperature.	0°C	- 2°C	During normal operation when power is on.	
	4	Defrosting end temperature.	7°C	12°C	During normal operation when power is on. (Except during defrosting)	
	5	Ignore oil-equalization circuit irregularities	Ordinary control	Ignore oil-equalization circuit irregularities	During normal operation when power is on.	
	6	-	-	-	-	
	7	-	-	-	-	
	8	-	-	-	-	
	9	Models (Refrigerant)	R22 Model	R407C Model	Before power is turned on.	
	10	Models (Capacity)	Model 200	Model 250	When switching on the power.	

Note 1: Factory setting is SWU 1 to 2 = 00, SW3 - 10 = set by model. All other switches are set to OFF.

Note 2: If the address is set from 01 to 50, it automatically becomes 100.

(2) Indoor unit
DIP SW1, 3

Switch	SW name	Operation by SW		Switch set timing		Remarks
		OFF	ON	OFF	ON	
SW1	1	Room temp. sensor position	Indoor unit inlet	Built in remote controller		
	2	Clogged filter detect.	None	Provided		
	3	Filter duration	100h	2500h		
	4	OA intake	Ineffective	Effective		Always ineffective for PKFY-P.VAM
	5	Remote display select.	Fan output display	Thermo. ON signal display		
	6	Humidifier control	At stationary heating	Always at heat.		
	7	Heating thermo. OFF airflow	Very low speed	Low speed		
	8	Heating thermo. OFF airflow	SW1-7 setting	Set airflow		
	9	Power failure automatic return	Ineffective	Effective		
	10	Power source start/stop	Ineffective	Effective		
SW3	1	Model selection	Heat pump	Cool. only	At unit stopping (at remote controller OFF)	
	2	Louver <small>(Cooling capacity saving for PKFY-P.VAM, effective/ineffective)</small>	None	Provided		
	3	Vane	None	Provided		
	4	Vane swing function	None	Provided		Not provided for PKFY-P.VAM Provided for PLFY-P.VGM (ON) setting
	5	Vane horizontal angle	1st setting	2nd setting		
	6	Vane angle set for cooling	Down blow B, C	Horizontal		Always down blow B,C for PKFY-P.VAM Horizontal (ON) setting for PLFY-P.VLMD
	7	–	–	–		
	8	Heating 4deg up	Effective	Ineffective		Ineffective (ON) setting for floor standing
	9	–	–	–		
	10	–	–	–		

Note 1: The shaded part indicates the setting at factory shipment. (For the SW not being shaded, refer to the table below.)

Model	Switch	PLFY-P			PEFY-P		PDFY-P	PFFY-P	PCFY-P	PKFY-P	
		VBM	VLMD	VKM	VML	VMH	VM	VLRM, VLEM	VGM	VAM	VGM
SW1	3	OFF	ON		OFF	ON	ON	OFF	ON	OFF	
	6	OFF	ON						OFF		
	7	OFF			ON		OFF				
SW3	3	ON			OFF			ON			
	4	ON	OFF	ON	OFF			ON	OFF	ON	
	6	OFF	ON	OFF							
	8	OFF				ON		OFF			

Note 2: The DipSW setting is only effective during unit stopping (remote controller OFF) for SW1, 2, 3 and 4 commonly and the power source is not required to reset.)

3: When both SW1-7 and SW1-8 are being set to ON, the fan stops at the heating thermostat of OFF.

Setting of DIP SW2

Model	P20	P25	P32	P40	P50	P63
Capacity (model name) code	4	5	6	8	10	13
SW2 setting	ON OFF	ON OFF	ON OFF	ON OFF	ON OFF	ON OFF

Model	P71	P80	P100	P125	P140	P200	P250
Capacity (model name) code	14	16	20	25	28	40	50
SW2 setting	ON OFF	ON OFF	ON OFF	ON OFF	ON OFF	ON OFF	ON OFF

Setting of DIP SW4

Setting of DIP SW5

Model	Circuit board used	SW4			
		1	2	3	4
PMFY-P-DBM	Phase control	ON	OFF	ON	OFF
PLFY-P-VLMD		-	-	-	-
PDFY-P20 ~ 80VM		ON	OFF	ON	OFF
PLFY-P40 ~ 63VKM		OFF	OFF	OFF	ON
PLFY-P80 ~ 125VKM		ON	OFF	OFF	ON
PCFY-P-VGM		OFF	ON	OFF	ON
PKFY-P-VGM		OFF	OFF	ON	ON
PKFY-P-VAM		-	-	-	-
PFFY-P-VLEM, P-VLRM	Relay selection	OFF	OFF	OFF	-
PEFY-P20 ~ 32VML		ON	ON	ON	-
PEFY-P40 ~ 140VMH		OFF	OFF	OFF	-
PEHY-P200-250VMH		ON	OFF	OFF	-
PDFY-P100-125VM		OFF	OFF	ON	-

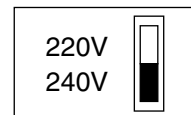

Switch	Function	Operation by switch	Switch set timing																
SWA	Ceiling height setting	<p>(PLFY-P-VKM) (PCFY-P-VGM) (PDFY-P-VM)</p> <p>* The ceiling height is changed by SWB setting.</p> <table border="1"> <thead> <tr> <th colspan="2">Ceiling height</th> </tr> </thead> <tbody> <tr> <td>3</td> <td>3.5 m</td> </tr> <tr> <td>2</td> <td>2.8 m</td> </tr> <tr> <td>1</td> <td>2.3 m</td> </tr> </tbody> </table>	Ceiling height		3	3.5 m	2	2.8 m	1	2.3 m	Always after powering								
Ceiling height																			
3	3.5 m																		
2	2.8 m																		
1	2.3 m																		
SWA	For options	<p>(PLFY-P-VLMD)</p> <p>* As this switch is used by interlocking with SWC, refer to the item of SWC for detail.</p>	Always after powering																
SWB	Setting of air outlet opening	<table border="1"> <thead> <tr> <th>SWA \ SWB</th> <th>1</th> <th>2</th> <th>3</th> </tr> </thead> <tbody> <tr> <td>2-way</td> <td>3.5 m</td> <td>3.8 m</td> <td>3.8 m</td> </tr> <tr> <td>3-way</td> <td>3.0 m</td> <td>3.3 m</td> <td>3.5 m</td> </tr> <tr> <td>4-way</td> <td>2.7 m</td> <td>3.0 m</td> <td>3.5 m</td> </tr> </tbody> </table>	SWA \ SWB	1	2	3	2-way	3.5 m	3.8 m	3.8 m	3-way	3.0 m	3.3 m	3.5 m	4-way	2.7 m	3.0 m	3.5 m	Always after powering
SWA \ SWB	1	2	3																
2-way	3.5 m	3.8 m	3.8 m																
3-way	3.0 m	3.3 m	3.5 m																
4-way	2.7 m	3.0 m	3.5 m																
SWC	Airflow control	<p>(PLFY-P-VKM, PCFY-P-VGM, PKFY-P-VGM)</p> <p>* Set to the option to install the high efficiency filter</p> <p>(PLFY-P-VLMD)</p> <p>(PDFY-P-VM)</p>	Always after powering																

3 TEST RUN

[1] Before Test Run

(1) Check points before test run



1	Neither refrigerant leak nor loose power source/ transmission lines should be found.			
2	Confirm that the resistance between the power source terminal block and the ground exceeds 2MΩ by measuring it with a DC 500 V megger. Do not run if it is lower than 2MΩ. Note) Never apply the megger to the MAIN board. If applied, the MAIN board will be broken.			
3	Confirm that the Ball valve at gas and liquid, oil balance sides is being fully opened. Note) Certainly close the cap.			
4	Be sure that the crankcase heater has been powered by turning the main power source on at least 12 hours before starting the test run. The shorter powering time causes compressor trouble.			
5	If any of the power supply wires (L1, L2, L3, N, ⊕) are mistakenly connected, it is possible to damage the unit. Please exercise caution.			
6	A transmission booster (RP) is required when the number of connected indoor unit models in a cooling system exceeds the number of models specified in the chart below. Note) The maximum number of units that can be controlled is determined by the indoor unit model, the type of remote controller and their capabilities.			
	(*1) Capability of the connected indoor units	Remote controller type	Remote controller PAR-F 25MA	
			Prior to Ver. E	After Ver. F
		Number of connected indoor units that can be connected without a RP.		
		200 or lower	16 (32)	20 (40)
		200 or higher	16 (32)	16 (32)
	The number of indoor units and the total number of remote controllers is displayed within the parenthesis ().			
	(*1) If even one unit that is higher than 200 exists in the cooling system, the maximum capacity will be "200 or higher".			

* Please refer to the installation manual for more details.

* Before turning power on to the outdoor unit, first turn on the transmission booster. (If the outdoor unit are mistakenly turned on first, turn on the transmission booster and then reset the outdoor unit power.)

(2) Caution at inverter check

Because the inverter power portion in outdoor unit electrical part box have a lot of high voltage portion, be sure to follow the instructions shown below.

1	During energizing power source, never touch inverter power portion because high voltage (approx. 580 V) is applied to inverter power portion.		
2	When checking,		
		Shut off main power source, and check it with tester, etc.	
		Allow 10 minutes after shutting off main power source.	
		Open the MAIN board mounting panel, and check whether voltage of both ends of electrolytic capacitor is 20 V or less.	

(3) Check points for test run when mounting options

Built-in optional parts	Content of test run	Check point	Result
Mounting of drain water lifting-up mechanism	1 Release connector of pump circuit, check error detection by pouring water into drain pan water inlet.	Local remote controller displays code No. "2503", and the mechanism stops.	
		No overflow from drain pan.	
	2 After that, connect connector of circuit.	Drain water comes out by operations of drain pump.	
	3 Check pump operations and drainage status in cooling (test run) mode.	Sound of pump operations is heard, and drain water comes out.	
Mounting of permeable film humidifier	Check humidifier operations and water supply status in heating (test run) mode.	No water leak from connecting portions of each water piping.	
		Water is supplied to water supply tank, and float switch is operating.	

(4) Attention for mounting drain water lifting-up mechanism

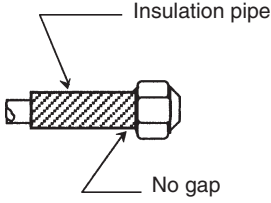
Work	Content of test run	Check point	Result
Disassembling and assembling of drain water lifting-up mechanism	1 Lead wire from control box not damaged.		
	2 Rubber cap properly inserted to drain water outlet of drain pan?		
	3 Insulation pipe of gas and liquid pipes dealt with as shown in the right figure?		
	4 Drain pan and piping cover mounted without gap?		
	5 Drain pan hooked on cut projection of the mechanism?		
Mounting of float switch	Float switch installed without contacting with drain pan?	1 Float switch moves smoothly.	
		2 Float switch is mounted on mounting board straightly without deformation.	
		3 Float switch does not contact with copper pipe.	
Electric wiring	1 No mistakes in wiring?	Wiring procedure is exactly followed.	
	2 Connectors connected surely and tightly?	Connector portion is tightly hooked.	
	3 No tension on lead wire when sliding control box?		

(5) Check points for system structure

In the case of the PUHY-(P) 400-500 YMF-B

Check points from installation work to test run.

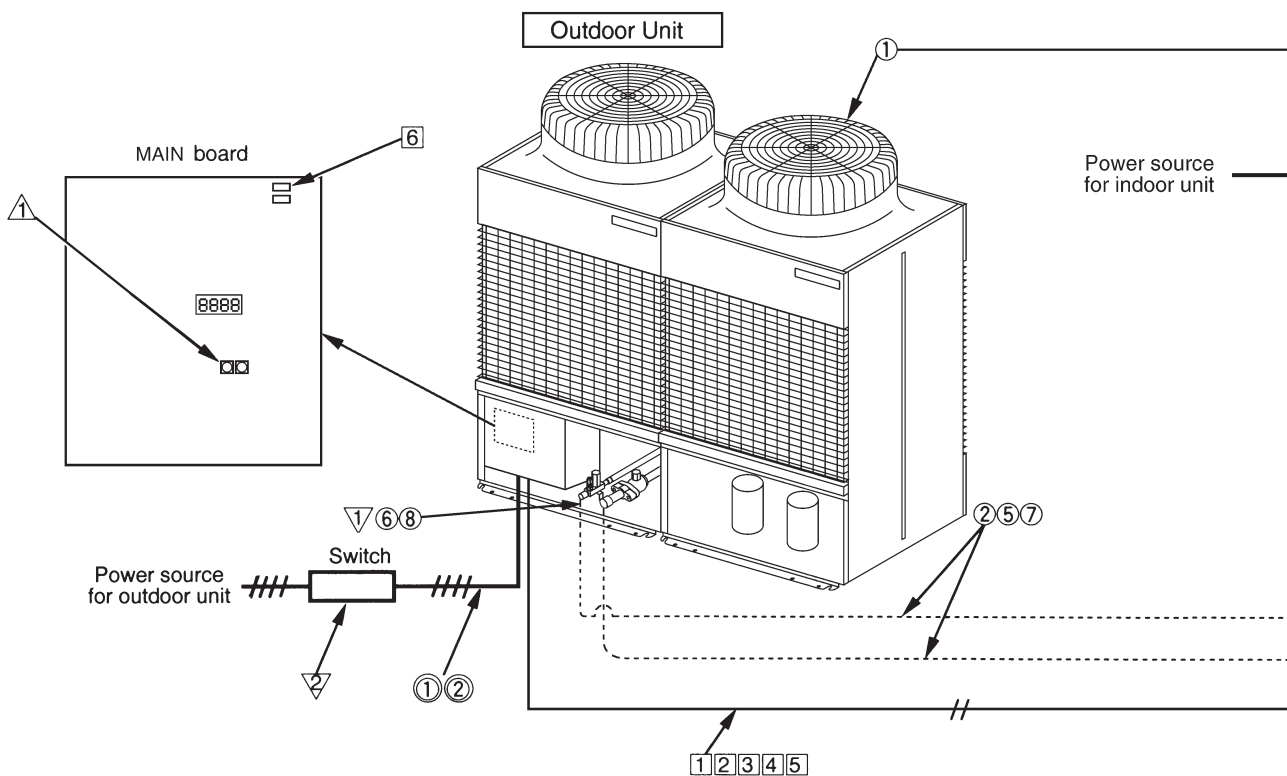

Classification	Portion	Check item	Trouble
Installation and piping	①	Instruction for selecting combination of outdoor unit, and indoor unit followed? (Maximum number of indoor units which can be connected, connecting model name, and total capacity.)	Not operate.
	②	Follow limitation of refrigerant piping length? For example, 100 m or less (total length: 220 m) at the farthest.	Not cool (at cooling). Not heat (at heating).
	③	Connecting piping size of branch piping correct?	
	④	Branch pipe properly selected?	
	⑤	Refrigerant piping diameter correct?	
	⑥	Refrigerant leak generated at connection?	
	⑦	Insulation work for piping properly done?	Condensation drip in piping.
	⑧	Specified amount of refrigerant replenished?	Not cool, not heat, error stop.
	⑨	Pitch and insulation work for drain piping properly done?	Water leak, condensation drip in drain piping.
Power source wiring	①	Specified switch capacity and wiring diameter of main power source used?	Error stop, not operate.
	②	Proper grounding work done on outdoor unit?	

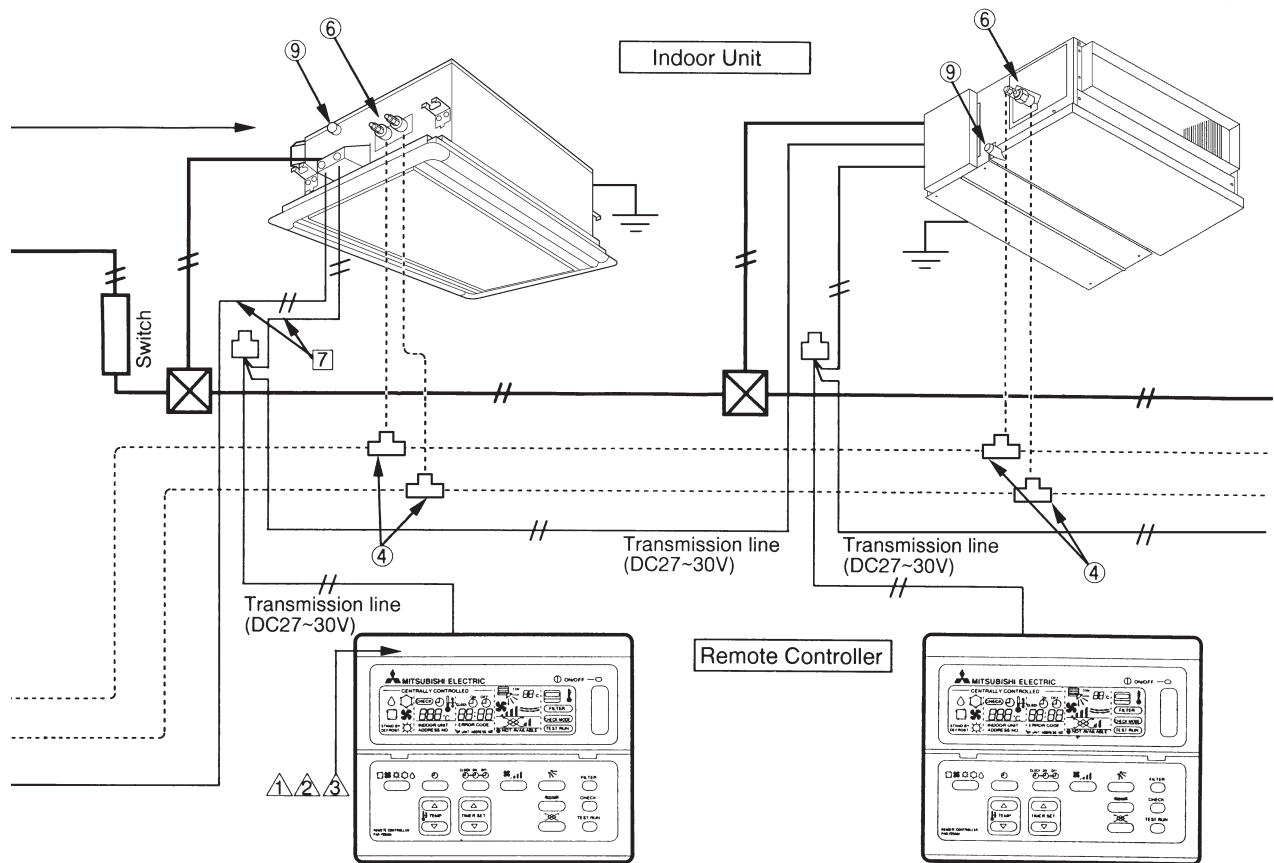

Classification	Portion	Check item	Trouble
Transmission line	①	Limitation of transmission line length followed? For example, 200 m or less (total length: 500 m) at the farthest.	Erroneous operation, error stop.
	②	1.25 mm ² or more transmission line used? (Remote controller 10 m or less 0.75 mm ²)	Erroneous operation, error stop.
	③	2-core cable used for transmission line?	Error stop in case multiple-core cable is used.
	④	Transmission line apart from power source line by 5 cm or more?	Erroneous operation, error stop.
	⑤	One refrigerant system per transmission line?	Not operate.
	⑥	The short circuit connector is changed form CN41 to CN40 on the MAIN board when the system is centralized control? (Just one outdoor unit. Not all outdoor units.)	Not operate.
	⑦	No connection trouble in transmission line?	Error stop or not operate.
System set	△1	Address setting properly done? (Remote controller, indoor unit and outdoor unit.)	Error stop or not operate.
	△2	Setting of address No. done when shutting off power source?	Can not be properly set with power source turned on.
	△3	Address numbers not duplicated?	Not operate.
	△4	Turned on SW3-8 on indoor unit circuit board when mounting room thermistor sensor?	Set temperature not obtained at heating operations. (Thermostat stop is difficult.)
Before starting	▽1	Refrigerant piping ball valve (Liquid pressure pipe, gas pressure pipe) opened?	Error stop.
	▽2	Turn on power source 12 hours before starting operations?	Error stop, compressor trouble.

In the case of the PUHY-(P) 600-650-700-750 YSMF-B
 Check points from installation work to test run.

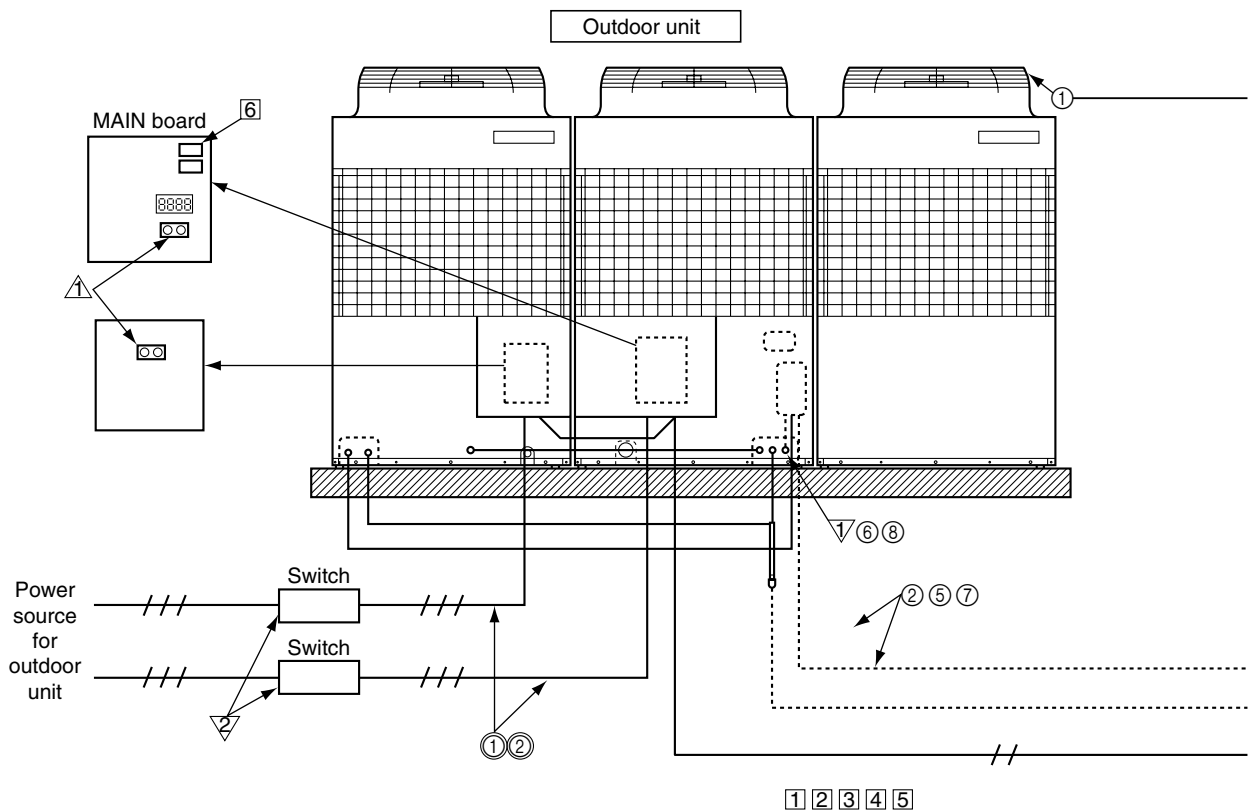





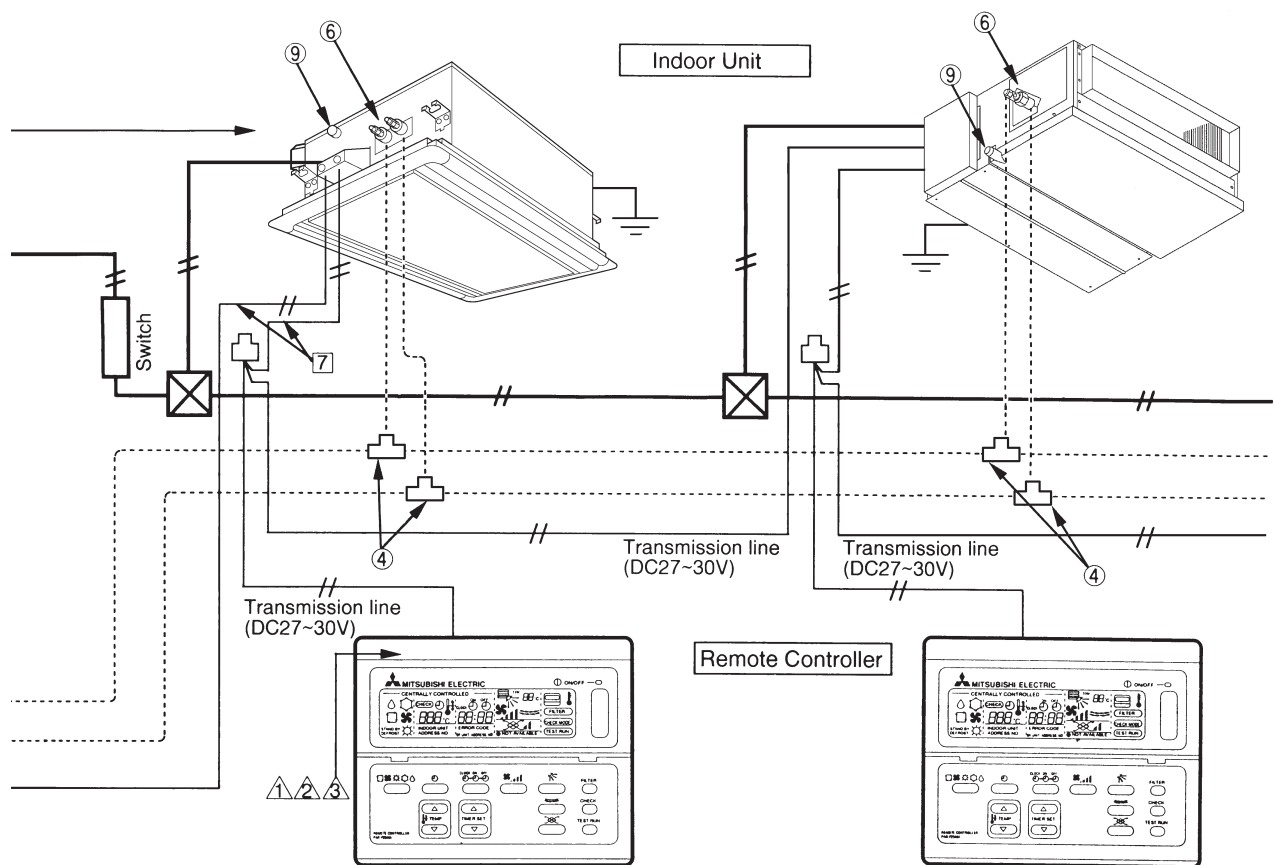



Classification	Portion	Check item	Trouble
Installation and piping	①	Instruction for selecting combination of outdoor unit, and indoor unit followed? (Maximum number of indoor units which can be connected, connecting model name, and total capacity.)	Not operate.
	②	Follow limitation of refrigerant piping length? For example, 100 m or less (total length: 220 m) at the farthest.	Not cool (at cooling). Not heat (at heating).
	③	Connecting piping size of branch piping correct?	
	④	Branch pipe properly selected?	
	⑤	Refrigerant piping diameter correct?	Not cool, not heat, error stop.
	⑥	Refrigerant leak generated at connection?	
	⑦	Insulation work for piping properly done?	Condensation drip in piping.
	⑧	Specified amount of refrigerant replenished?	Water leak, condensation drip in drain piping.
	⑨	Pitch and insulation work for drain piping properly done?	
Power source wiring	①	Specified switch capacity and wiring diameter of main power source used?	Error stop, not operate.
	②	Proper grounding work done on outdoor unit?	

* Limitations apply when 17 or more indoor units are connected. Please refer to the installation manual.



Classification	Portion	Check item	Trouble
Transmission line	①	Limitation of transmission line length followed? For example, 200 m or less (total length: 500 m) at the farthest.	Erroneous operation, error stop.
	②	1.25 mm ² or more transmission line used? (Remote controller 10 m or less 0.75 mm ²)	Erroneous operation, error stop.
	③	2-core cable used for transmission line?	Error stop in case multiple-core cable is used.
	④	Transmission line apart from power source line by 5 cm or more?	Erroneous operation, error stop.
	⑤	One refrigerant system per transmission line?	Not operate.
	⑥	The short circuit connector is changed form CN41 to CN40 on the MAIN board when the system is centralized control? (Just one outdoor unit. Not all outdoor units.)	Not operate.
	⑦	No connection trouble in transmission line?	Error stop or not operate.
System set	⚠1	Address setting properly done? (Remote controller, indoor unit and outdoor unit.)	Error stop or not operate.
	⚠2	Setting of address No. done when shutting off power source?	Can not be properly set with power source turned on.
	⚠3	Address numbers not duplicated?	Not operate.
	⚠4	Turned on SW3-8 on indoor unit circuit board when mounting room thermistor sensor?	Set temperature not obtained at heating operations. (Thermostat stop is difficult.)
Before starting	▽1	Refrigerant piping ball valve (Liquid pressure pipe, gas pressure pipe, oil balance pipe) opened?	Error stop.
	▽2	Turn on power source 12 hours before starting operations?	Error stop, compressor trouble.

[2] Test Run Method

Operation procedure	
①	Turn on universal power supply at least 12 hours before getting started → Displaying “HO” on display panel for about two minutes
②	Press TEST RUN button twice → Displaying “TEST RUN” on display panel
③	Press  selection button → Make sure that air is blowing out
④	Press  select button to change from cooling to heating operation, and vice versa → Make sure that warm or cold air is blowing out
⑤	Press  adjust button → Make sure that air blow is changed
⑥	Press  or  button to change wind → Make sure that horizontal or downward blow is adjustable
⑦	Make sure that indoor unit fans operate normally
⑧	Make sure that interlocking devices such as ventilator operate normally if any
⑨	Press ON/OFF button to cancel test run → Stop operation
<p>Note) 1. If check code is displayed on remote controller or remote controller does not operate normally. 2. Test run automatically stops operating after two hours by activation of timer set to two hours. 3. During test run, test run remaining time is displayed on time display section. 4. During test run, temperature of liquid pipe in indoor unit is displayed on remote controller room temperature display section. 5. When pressing  adjust button, depending on the model, “NOT AVAILABLE” may be displayed on remote controller. However, it is not a malfunction. 6. When pressing  or  button, depending on the model, “NOT AVAILABLE” may be displayed on remote controller. However, it is not a malfunction.</p>	

4 GROUPING REGISTRATION OF INDOOR UNITS WITH REMOTE CONTROLLER

(1) Switch function

- The switch operation to register with the remote controller is shown below:

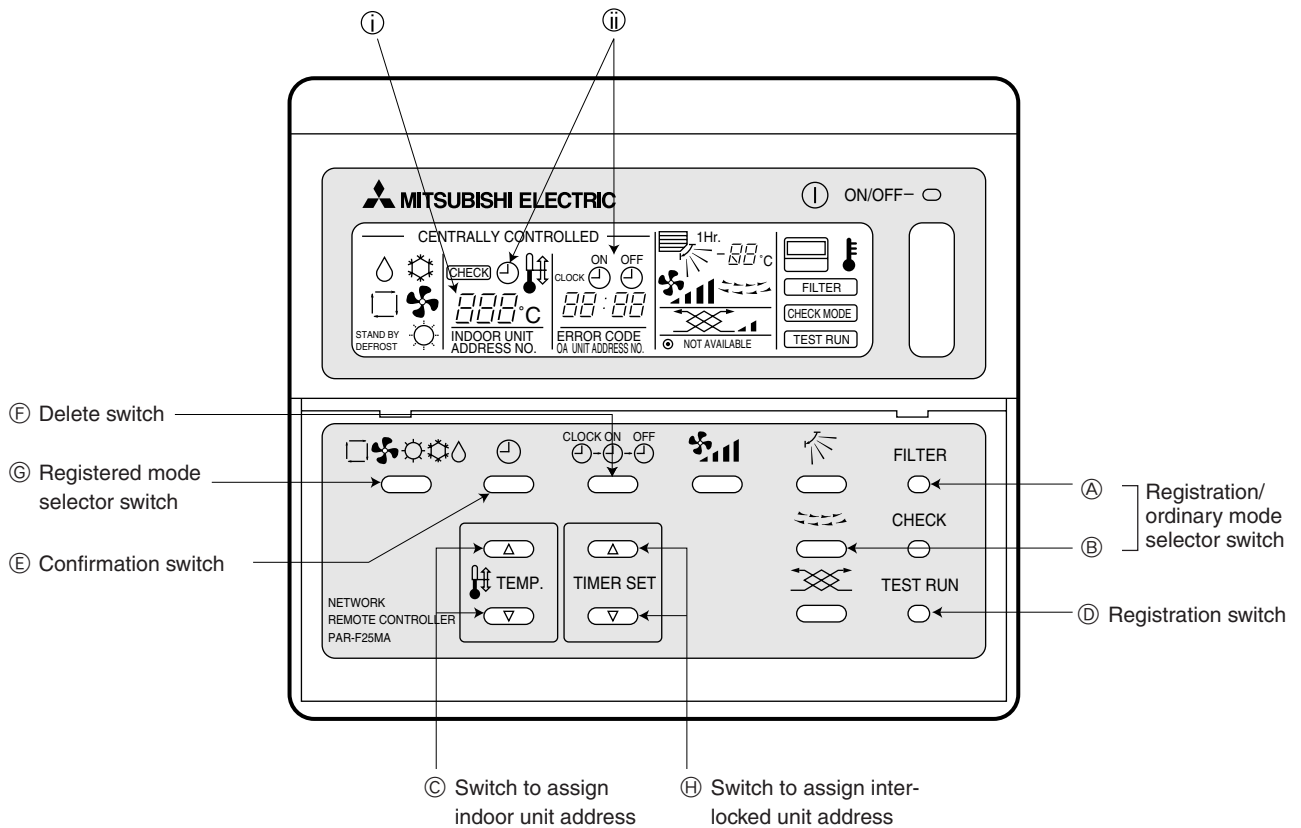

Name	Symbol of switch	Name of actual switch	Description
Registration/ordinary mode selection switch	Ⓐ + Ⓑ	(FILTER) +	This switch selects the ordinary mode or registered mode (ordinary mode represents that to operate indoor units). * To select the registered mode, press the (FILTER) + switch continuously for over 2 seconds under stopping state. Note) The registered mode can not be obtained for a while after powering. Pressing the (FILTER) + switch displays "CENTRALLY CONTROLLED".
Switch to assign indoor unit address	Ⓒ	of TEMP	This switch assigns the unit address for "INDOOR UNIT ADDRESS NO."
Registration switch	Ⓓ	(TEST RUN)	This switch is used for group/interlocked registration.
Confirmation switch	Ⓔ		This switch is used to retrieve/identify the content of group and interlocked (connection information) registered.
Delete switch	Ⓕ	CLOCK ON OFF	This switch is used to retrieve/identify the content of group and interlocked (connection information) registered.
Registered mode selector switch	Ⓖ		This switch selects the case to register indoor units as group (group setting mode) or that as interlocked (interlocked setting mode). * The unit address is shown at one spot ① for the group setting mode while at two spots ② for the interlocked setting mode.
Switch to assign interlocked unit address	Ⓖ	of TIMER SET	This switch assigns the unit address of "OA UNIT ADDRESS NO."

(2) Attribute display of unit

- At the group registration and the confirmation/deletion of registration/connection information, the type (attribute) of the unit is displayed with two English characters.

Display	Type (Attribute) of unit/controller
IL	Indoor unit connectable to remote controller
OL	Outdoor unit (PUHY-(P)400/500YMF-B)
OS	Outdoor unit (PUHN-(P)200/250YMF-B)
RL	Local remote controller
SL	System controller (MJ)

[Description of registration/deletion/retrieval]

- The items of operation to be performed by the remote controller are given below. Please see the relating paragraph for detail.

① Group registration of indoor unit

- The group of the indoor units and operating remote controller is registered.
- It is usually used for the group operation of indoor units with different refrigerant system.

② Retrieval/identification of group registration information of indoor units

- The address of the registered indoor units in group is retrieved (identified).

③ Retrieval/identification of registration information

- The connection information of any unit (indoor/outdoor units, remote controller or the like) is retrieved (identified).

④ Deletion of group registration information of indoor units

- The registration of the indoor units under group registration is released (deleted).

⑤ Deletion of the address not existing

- This operation is to be conducted when "6607" error (No ACK error) is displayed on the remote controller caused by the miss setting at test run, or due to the old memory remained at the alteration/modification of the group composition.

Caution:

When MELANS (MJ-103MTRA for example) is being connected, do not conduct the group/pair registration using the remote controller. The group/pair registration should be conducted by MELANS. (For detail, refer to the instruction exclusively prepared for MELANS.)



(3) Group registration of indoor unit

1) Registration method

- Group registration of indoor unit ①

The indoor unit to be controlled by a remote controller is registered on the remote controller.

[Registration procedure]

- ① With the remote controller under stopping or at the display of “HO”, continuously press the (FILTER) +  switch (A + B) at the same time for 2 seconds to change to the registration mode. (See the figure below.)
- ② Assign the indoor unit address to “INDOOR UNIT ADDRESS NO.” by operating the (▲) (▼) (Room temperature adjustment) (C).
- Then press the (TEST RUN) switch (D) to register. In the figure below, the “INDOOR UNIT ADDRESS NO.” is being set to 001.
- ③ After completing the registration, press the (FILTER) +  switch (A + B) at the same time for 2 seconds to change to the original ordinary mode (with the remote controller under stopping).

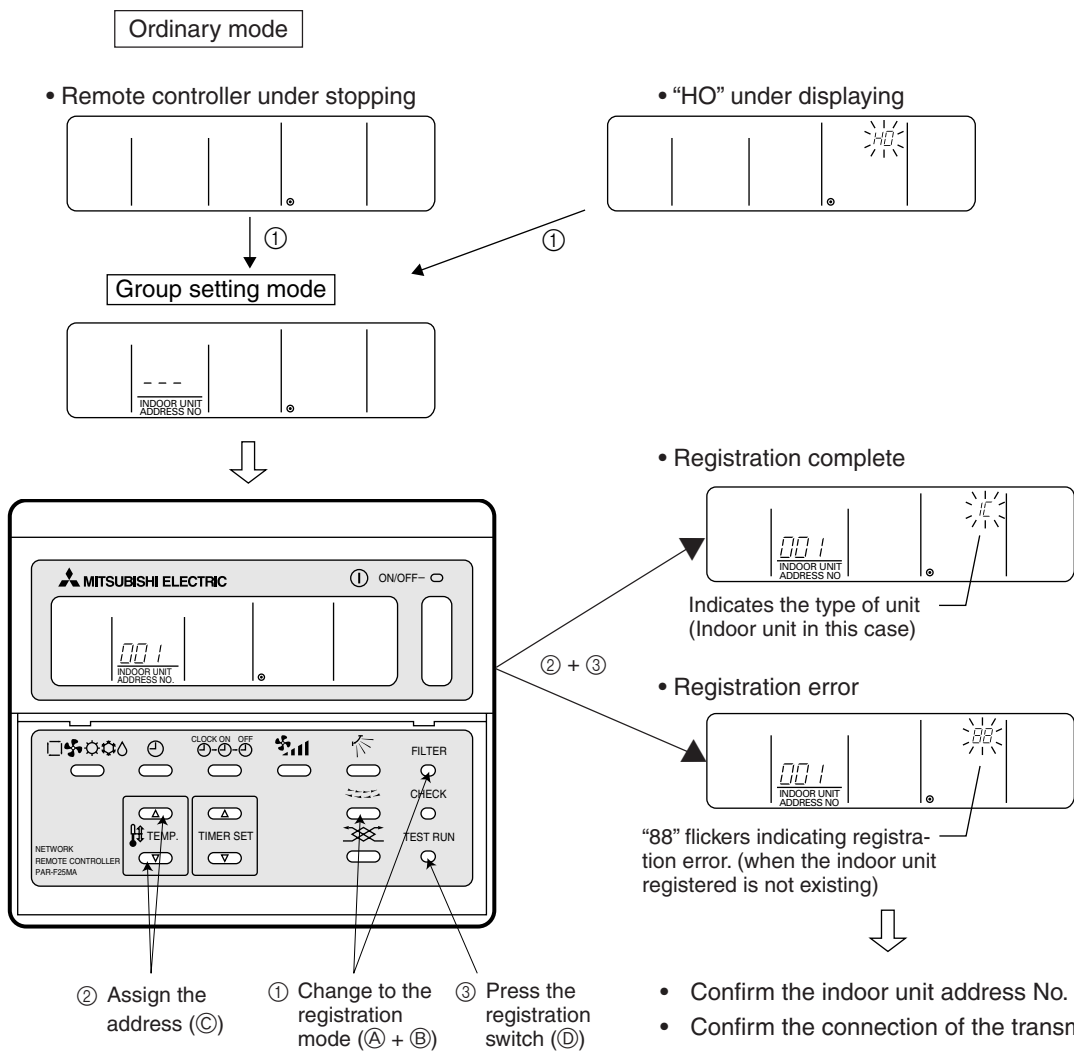

- Confirm the indoor unit address No.
- Confirm the connection of the transmission line.

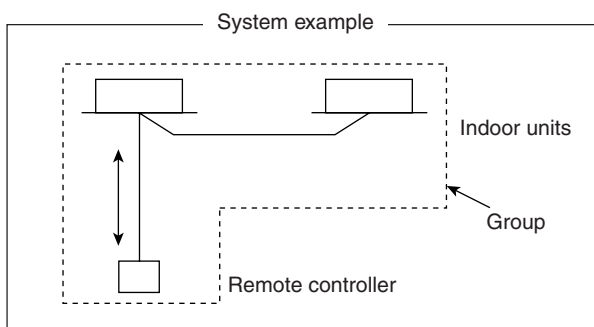

2) Method of retrieval/confirmation

- Retrieval/confirmation of group registration information on indoor unit..... [2]

The address of the indoor unit being registered on the remote controller is displayed.

[Operation procedure]

- ① With the remote controller under stopping or at the display of "HO", continuously press the (FILTER) + [switch (A) + (B)] at the same time for 2 seconds to change to the registration mode.
- ② In order to confirm the indoor unit address already registered, press [switch (E)]. (See figure below.) When the group of plural sets is registered, the addresses will be displayed in order at each pressing of [switch (E)].
- ③ After completing the registration, continuously press the (FILTER) + [switch (A) + (B)] at the same time for 2 seconds to change to the original ordinary mode (with the remote controller under stopping).

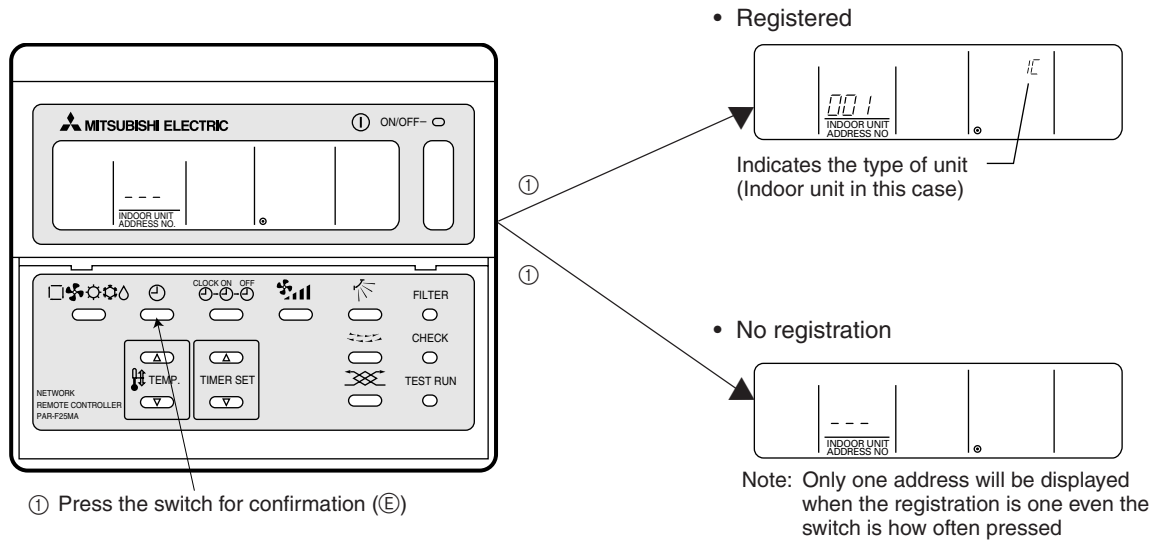

① Press the switch for confirmation (E)

- Retrieval/confirmation of registration information [3]

The registered information on a certain unit (indoor unit, outdoor unit, remote controller or the like) is displayed.

[Operation procedure]

- ① With the remote controller under stopping or at the display of "HO", continuously press the (FILTER) + [switch (A) + (B)] at the same time for 2 seconds to change to the registration mode.
- ② Operate [switch (C)] for the interlocked setting mode. (See figure below.)
- ③ Assign the unit address of which registration information is desired to confirm with the [switch (H)]. Then press the [switch (E)] to display it on the remote controller. (See figure below.) Each pressing of [switch (E)] changes the display of registered content. (See figure below.)
- ④ After completing the retrieval/confirmation, continuously press the (FILTER) + [switch (A) + (B)] at the same time for 2 seconds to change to the original ordinary mode (with the remote controller under stopping).

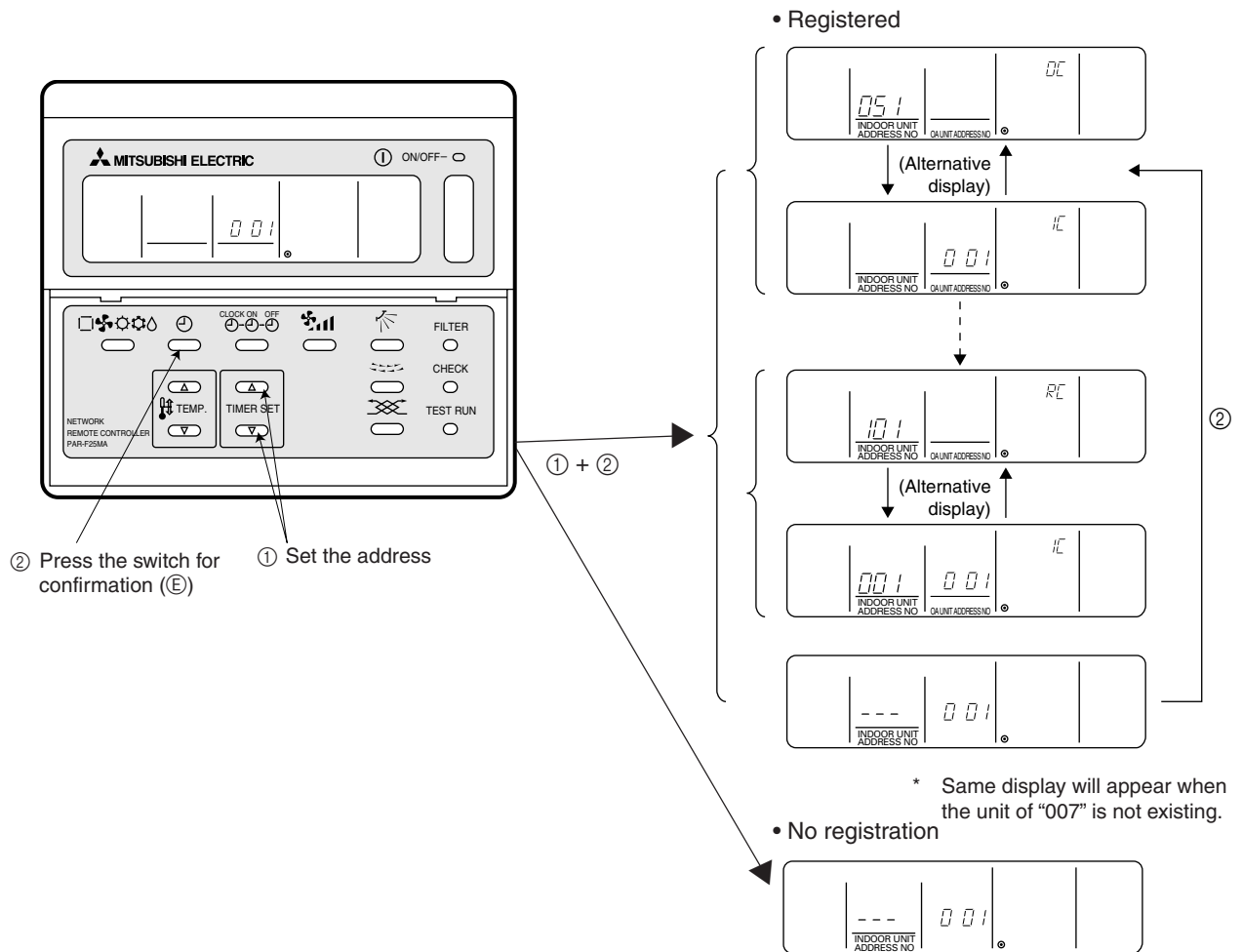

3) Method of deletion

- Deletion of group registration information of indoor unit 4

[Operation procedure]

- ① With the remote controller under stopping or at the display of "HO", continuously press the (FILTER) + (A) + (B) switch (A) + (B) at the same time for 2 seconds to change to the registration mode.
- ② Press the (E) switch (E) to display the indoor unit address registered. (As same as 2)
- ③ In order to delete the registered indoor unit being displayed on the remote controller, press the (CLOCK) (ON) (OFF) (F) switch two times continuously. At completion of the deletion, the attribute display section will be shown as "--". (See figure below.)

Note: Completing the deletion of all indoor units registered on the remote controller returns to "HO" display.

- ④ After completing the registration, continuously press the (FILTER) + (A) + (B) switch (A) + (B) at the same time for 2 seconds to change to the original ordinary mode (with the remote controller under stopping).

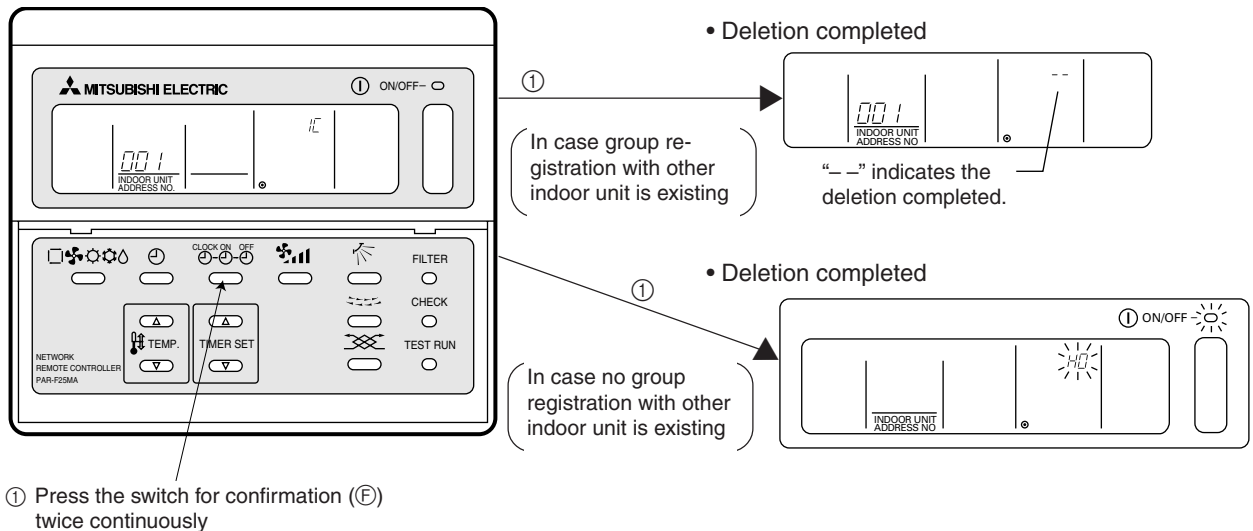

4) Deletion of information on address not existing

- Deletion of information on address not existing 5

This operation is to be conducted when “6607” error (No ACK error) is displayed on the remote controller caused by the miss setting at test run, or due to the old memory remained at the alteration/modification of group composition, and the address not existing will be deleted.

Note : The connection information (connection between indoor unit and outdoor unit) on the refrigerant system can not be deleted.

An example to delete the system controller of “250” from the indoor unit of “007” is shown below.

[Operation procedure]

- ① With the remote controller under stopping or at the display of “HO”, continuously press the (FILTER) + (A) + (B) switch at the same time for 2 seconds to change to the registration mode.
- ② Operate (C) switch for the interlocked setting mode (ii). (See the figure below.)
- ③ Assign the unit address existing to “OA UNIT ADDRESS No.” with the (D) (Room temperature control) switch (C), and press (E) switch to call the address to be deleted. (See the figure below.) As the error display on the remote controller is usually transmitted from the indoor unit, “OA UNIT ADDRESS No.” is used as the address of the indoor unit.
- ④ Press the (F) switch twice. (See the figure below.)
- ⑤ After completing the deletion, continuously press the (FILTER) + (A) + (B) switch at the same time for 2 seconds to return to the original ordinary mode (with the remote controller under stopping).

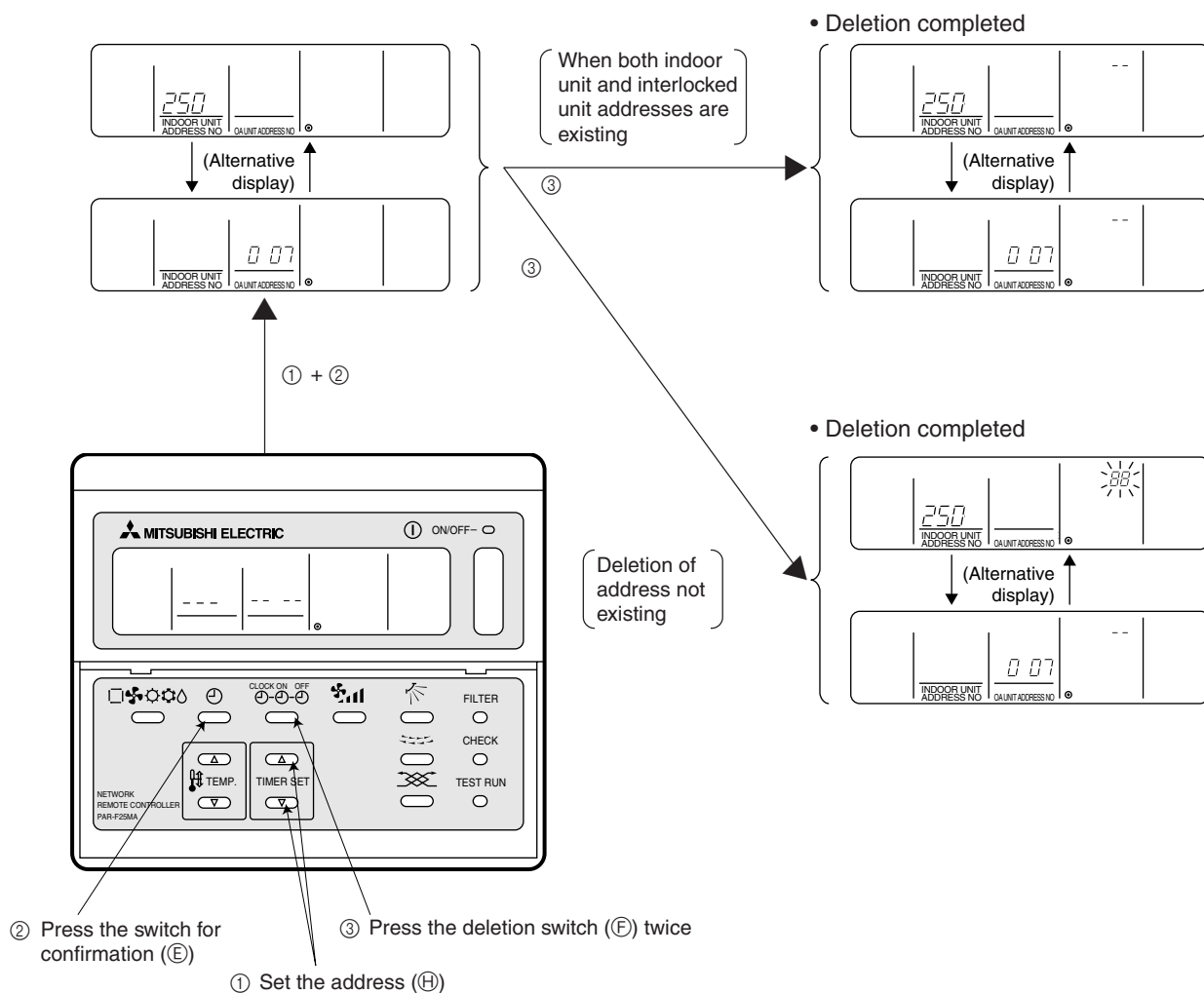

5 CONTROL

[1] Control of Outdoor Unit

[1]- 1 PUHY-P400-500 YMF-B

(1) Initial processing

- When turning on power source, initial processing of microcomputer is given top priority.
- During initial processing, control processing corresponding to operation signal is suspended. The control processing is resumed after initial processing is completed. (Initial processing: Data processing in microcomputer and initial setting of each LEV opening, requiring approx. 2 minutes at the maximum.)

(2) Control at starting

- For 3 minutes after starting, 60 Hz is the upper frequency limit. (When only No. 1 compressor is operating.)
- 75 Hz is the upper limit within 2 hours after the power supply has been turned ON and for the 30 minutes after the compressor has started operation.
- Normal control is performed after the initial start mode (described later) has been completed.

(3) Compressor capacity control

- Variable capacitor compressor is performed by the variable capacity compressor (No. 1: inverter motor) and constant capacity compressor (No. 2: It has capacity control switching).
- In response to the required performance, the number of compressors operating, the switching of capacity control and the frequency of the variable capacitor compressor is controlled so that the evaporation temperature is between -2 and -6°C in cooling mode and that the condensation temperature is 49°C in heating mode.
- The fluctuation of the frequency of the variable capacitor compressor is as follows. It is performed at 2 Hz per second.
20 to 100 Hz (TH6 > 20°C and in cooling mode, or in heating mode)
30 to 100 Hz (TH6 < 20°C and in cooling mode)

1) No. 2 compressor operation, stopping and full-load/un-load switching

① Switching from stopping to operation of No. 2 compressor.

When the required performance cannot be obtained by only No. 1 compressor, the No. 2 compressor will be started. (The No. 2 compressor will be started in un-load operation.)

- After the No. 1 compressor has reached 100 Hz, the No. 2 compressor stops → un-load or un-load → full-load.

② Switching from operation to stopping of No. 2 compressor.

When the required performance is exceeded when the two compressors, No. 1 and No. 2, are operating, the No. 2 compressor is stopped or performed in un-load operation.

③ Switching from un-load to full-load of No. 2 compressor

When the required performance cannot be obtained by the No. 1 compressor and the No. 2 compressor operating in un-load, the No. 2 compressor will be switched to full-load operation.

④ Switching from full-load to un-load of No. 2 compressor

When the required performance is exceeded when the two compressors, No.1 and No. 2 operating in full-load, the No 2 compressor will be switched to un-load operation.

2) Pressure control

The upper limit value for the high pressure (Pd) has been set for each frequency. When this value is exceeded, the frequency is reduced every 30 seconds.

3) Discharge temperature control

The discharge temperature of the compressor (Td) is monitored during the operation. If the upper limit is exceeded, the frequency is reduced by 5 Hz.

- Control is performed every 30 seconds after 30 seconds at the compressor starting.

- The operating temperature is 124°C (No. 1 compressor) or 115°C (No. 2 compressor).

4) Compressor frequency control

① Ordinary control

The ordinary control is performed after the following times have passed.

- 30 seconds after the start of the compressor or 30 seconds after the completion of defrosting.
- 30 seconds after frequency control operation by the discharge temperature or the high pressure.

② Amount of frequency fluctuation

The amount of frequency fluctuation is controlled in response to the evaporation temperature (Te) and the condensation temperature (Tc) so that it will be approached the target values.

③ Frequency control back-up by the bypass valve

Frequency control is backed-up by the turning on (opening) the bypass valve (SV4) when only the No. 1 compressor is operated at its lowest frequency.

• Cooling

After the compressor has been operated for 15 minutes and only the No. 1 compressor is operated in un-load (its lowest frequency), the bypass valve is turned ON when the low pressure (63 LS) is 1.0 kg/cm² G (0.098 MPa) or less and turned OFF when it is 2.0 kg/cm² G (0.196 MPa) or more.

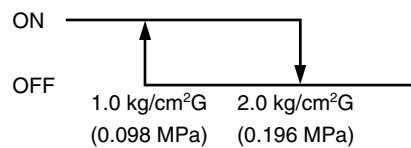

• Heating

After the compressor has been operated for 3 minutes and only the No. 1 compressor is operated in un-load (its lowest frequency), the bypass valve is turned ON when the high pressure (Pd) exceeds 27 kg/cm² (2.65 MPa) and turned OFF when it is 24 kg/cm² (2.35 MPa) or less.

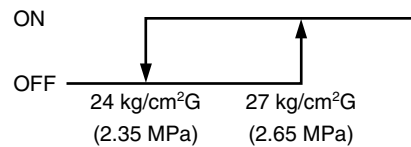

(4) Bypass - capacity control

The solenoid valves have bypass valves (SV1, SV4 and SV6) that allow bypassing of the high pressure and low pressure sides and solenoid valves (SV22 and SV32) that control the capacity control valve inside the compressor. They operate as follows.

1) Bypass valve (SV6) [SV6 is on (open)]

- As shown in the table below, control is performed by the operation and stopping of the No. 1 compressor and No. 2 compressor.

No. 1 compressor	No. 2 compressor	SV6
Stop	Stop	OFF
Operate	Stop	ON
Operate	Operate	OFF

2) Bypass solenoid valves (SV1, SV4) [Both SV1 and SV4 are on (open)]

Item	SV1		SV4	
	ON	OFF	ON	OFF
At compressor is started	ON for 4 minutes		—	
Compressor stopped during cooling or heating mode	ON		—	
After operation has been stopped	ON for 3 minutes		—	
During defrosting (*1) in Fig below)	ON		Normally ON	
During oil recovery operation	ON during oil recovery operation after continuous low-frequency compressor operation.		—	
When low pressure (Ps) has dropped during lower limit frequency operation(15 minutes after start)	—		Ps < 1.0 kg/cm ² G (0.098 MPa)	Ps ≥ 2.0 kg/cm ² G (0.196 MPa)
When the high pressure (Pd) is risen up during lower limit frequency operation (3 minutes after starting)	Pd ≥ 27.5 kg/cm ² G (2.70 MPa)	Pd ≤ 24 kg/cm ² G (2.35 MPa) and after 30 seconds.	Pd ≥ 27 kg/cm ² G (2.65 MPa)	Pd ≤ 24 kg/cm ² G (2.35 MPa) and after 30 seconds
	—		ON when the high pressure (Pd) exceeds the control pressure limit.	Pd ≤ 20 kg/cm ² G (1.96 MPa)
When the discharge temperature (Td) is risen up	—		<ul style="list-style-type: none"> Td > $\begin{cases} 130^{\circ}\text{C} & \text{(No. 1 compressor)} \\ 115^{\circ}\text{C} & \text{(No. 2 compressor)} \end{cases}$ and Pd > 20 kg/cm²G (1.96 MPa) or Ps < 3.5 kg/cm²G (0.34 MPa) 	<ul style="list-style-type: none"> Td ≤ $\begin{cases} 115^{\circ}\text{C} & \text{(No. 1 compressor)} \\ 100^{\circ}\text{C} & \text{(No. 2 compressor)} \end{cases}$

* Example of operation of SV1

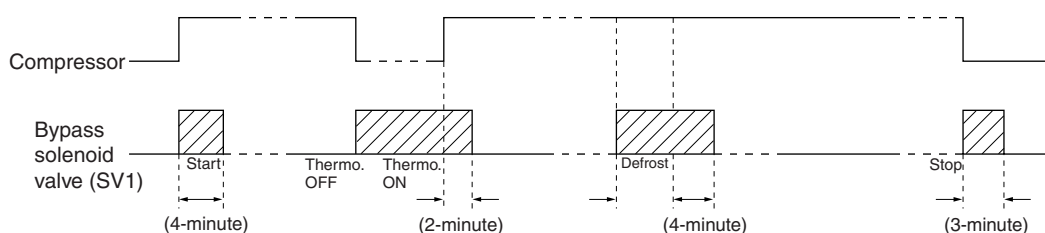

3) Capacity control solenoid valve (SV22, SV32).

• Operation of solenoid valve

Solenoid valve	SV22		SV32	
	Coil	Valve	Coil	Valve
Full-load (Operating at 100 % capacity)	OFF	Open	OFF	Closed
Un-load (Capacity control operation)	ON	Closed	ON	Open

- SV22 and SV32 stand for SV2 and SV3 of the No. 2 compressor.

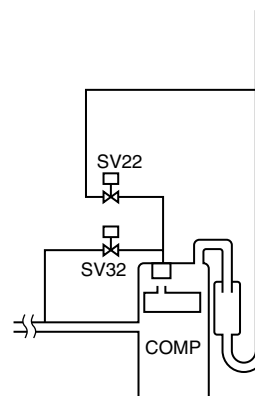

(5) Oil return control (Electronic expansion valve (SLEV))

- The amount of opening of the oil-return LEV (SLEV) is determined as follows: in cooling, by the operating capacity of the No. 1 compressor and the ambient temperature; in heating, by the operating capacity of the No. 1 compressor.
- It is opened (64) when both compressors are stopped and started for 10 minutes. (Upper limit of LEV opening is So = 388 pulse.)
- SLEV = 0 when the No. 1 compressor is stopped.

(6) Sub-cool coil control (Electronic expansion valve (LEV1))

- The sub-cool coil control provides control every 30 seconds to keep the super heat volume from the temperature of the inlet/outlet of the sub-cool coil (TH8, TH9) within a stable range (2 to 4 degrees).
- It controls by correcting the amount of opening according to the temperature of the inlet/outlet of the sub-cool coil (TH5, TH7), the high pressure (Pd) and discharge temperature.
- It is closed (0) in heating or when the compressor is stopped.
- It has a fixed opening (480) in defrosting.
- During normal control, the operating range is 46 to 480.

(7) Defrosting control

1) Start of defrosting

- After there has been heating operation for 50 minutes or after 90 minutes has passed and a piping temperature (TH5) of -8°C or less is detected for a preset time, defrosting begins.
- When 10 minutes has passed since the compressor began operation or if 10 minutes has passed since recovery from defrosting, setting the forced defrosting switch (Dip SW2-7) to starts forced defrosting.

2) End of defrosting

- Defrosting ends when 15 minutes have passed since the start of defrosting, or when a piping temperature (TH5) of 7°C or more is detected for 2 minutes or longer. (Note that if the defrost-prohibited time is set on 90 minutes, the defrost-prohibit time will be 50 minutes following a 15-minute timed recovery.)
- Ending the defrosting is prohibited for 2 minutes after the start of defrosting. (Note that the defrosting operation will be ended if the piping temperature exceeds 20°C within 2 minutes of the start of defrosting.)

3) Defrost-prohibit

- Defrosting is not performed for 10 minutes after the start of compressor operation and during oil recovery mode.

4) Abnormalities during defrosting

- If an error is detected during defrosting, the defrosting is stopped and the defrost-prohibit time is set to 20 minutes by the compressor cumulative operating time.

- 5) Change in number of operating indoor units while defrosting
 - If the number of indoor units changes while the outdoor unit is defrosting, the defrosting operation continues. Once defrosting has ended, control for changing the number of units is performed.
 - If the indoor unit is stopped while the outdoor unit is defrosting or if the thermostat is set to off, the defrosting operation continues. Once defrosting has ended, the unit is stopped.
- 6) Number of compressors operating during defrosting
 - The number of compressors operating during defrosting is always two.

(8) Control of liquid level detecting heater

Detect refrigerant liquid level in accumulator, and heat refrigerant with liquid level heater for judging refrigerant amount. 7 steps of duty control is applied to liquid level heater depending on frequency and outdoor air temperature, 1 minute after starting compressor.

(9) Judgement and control of refrigerant amount

- Judge refrigerant amount by detecting refrigerant liquid surface accumulator.

1) Judgement of accumulator liquid level

- Return refrigerant from accumulator liquid level detecting circuit to compressor inlet pipe, detect piping temperature, and judge liquid level.

When heated with heater, liquid refrigerant temperature is almost equal to low pressure saturation temperature, and gas refrigerant temperature is a little higher than low pressure saturation temperature. By comparing these temperatures A in accumulator inlet portion, refrigerant liquid level can be judged.

Accumulator liquid level is judged in 3 steps as shown in the figure, from temperature A and liquid level detecting temperatures (TH3, TH4). After deciding refrigerant status (Liquid: TH3 and TH4 are TH2 + 9°C or less, Gas: TH3 and TH4 are TH2 + 9°C or more), judge liquid level by comparing TH3 and TH4.

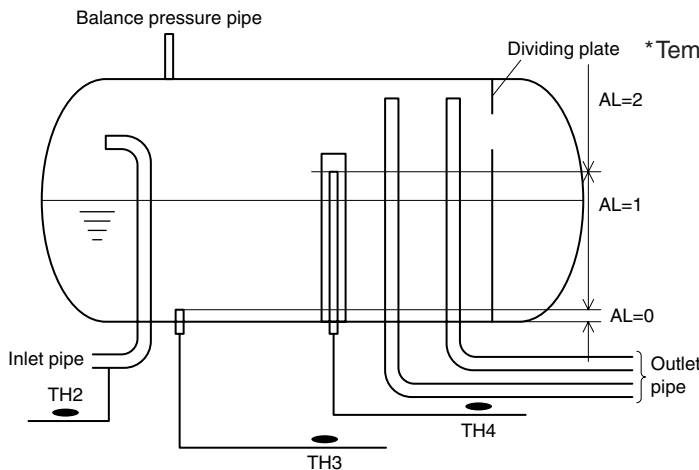

* Temperature A: low pressure saturation temperature (TH2).

- Judgement by the AL is at best only a rough guideline. Please do not add refrigerant based on the AL reading alone.

2) Control of liquid level detection

① Prohibition of liquid level detection

Liquid level is detected in normal conditions except for the following;

(Cooling)

- For 6 minutes after starting unit, and during unit stopping.

(Heating)

- For 6 minutes after starting unit, and during unit stopping.
- During defrosting.
- For 10 minutes after refrigerant recovery.

(Note that liquid level determination is being performed even when liquid level detection is being disregarded.)

② In case AL = 2 is detected for 3 consecutive minutes during liquid level detection (control at excessive refrigerant replenishment and trouble mode)

- Changed to intermittent fault check mode preceded by 3 minutes restart prevention. But it is not abnormal when the discharge SH is high. Error stop is observed when trouble is detected again in the same intermittent fault check mode (for 30 minutes after unit stops for intermittent fault check).

- When turning on liquid level trouble ignore switch (SW2-4), error stop is not observed, and 3 minutes restart prevention by intermittent fault check mode is repeated. However, LED displays overflow.

(Turning SW2-4 on makes the error of TH6 < outdoor air sensor > ineffective.)

③ When operation mode shows "Stop," excessive or insufficient refrigerant display and excessive or insufficient refrigerant ignore display are extinguished.

(10) Refrigerant recovery control

Refrigerant recovery is conducted to prevent refrigerant from accumulating in the stopped unit (fan unit), the unit under cooling mode and that with heating thermostat being turned off.

1) Start of refrigerant recovery

- ① Refrigerant recovery is started when the two items below are fully satisfied.
 - 30 minutes has passed after finishing refrigerant recovery.
 - The level detector detects AL = 0 for 3 minutes continuously, or the discharge SH is high.

2) Refrigerant recovery operation

- Refrigerant is recovered by opening LEV of the objective indoor units (indoor units under stop. fan, and cooling modes, and that with heating thermostat being turned off) for 30 seconds.

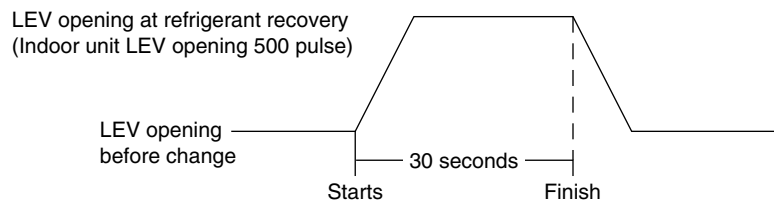

- The regular capacity control of the outdoor unit and the regular LEV control of the indoor unit are not applied during refrigerant recovery operation, but are fixed with the value before the recovery operation. These controls will be conducted one minute after finishing the recovery operation.
- Defrosting operation is prohibited during the recovery operation, and it will be conducted after finishing the recovery operation

(11) Outdoor unit heat exchanger capacity control

1) Control method

- In order to stabilize the evaporation temperature during cooling and the high-pressure pressure during heating that are required in response to performance needs, the capacity of the outdoor heat exchanger is controlled by regulating the fan volume of the outdoor unit by phase control and controlling the number of fans and by using the solenoid valves.

2) Control

- When both of the compressors are stopped, the fans for the outdoor units are also stopped.
- The fans operate at full speed for 10 seconds after starting.
- The fans for the outdoor unit are stopped during defrosting.

3) Capacity control pattern

Operating mode	Capacity control pattern	Heat exchanger capacity	No. of fans	Phase control	Notes
Cooling	①	50 %	1	10 to 100 %	21S4bON SV5bON
	②	100 %	2	10 to 100 %	21S4bOFF SV5bOFF
Heating	①	100 %	2	10 to 100 %	21S4bON SV5bOFF
Defrosting	①	100 %	0	0 %	21S4bOFF SV5bOFF

Note 1: When there is conductivity at SV5b, it is open. When there is no conductivity at SV5b, it is closed.

Note 2: When the unit is stopped, and SV5b are open.

(12) Control at initial starting

- When the ambient temperature is low (5°C or less in cooling and – 5°C or less in heating), initial starting will be performed if the unit is started within 4 hours of the power being turned on.
- The following initial start mode will be performed when the unit is started for the first time after the power has been turned on.

<Flow chart of initial start mode>

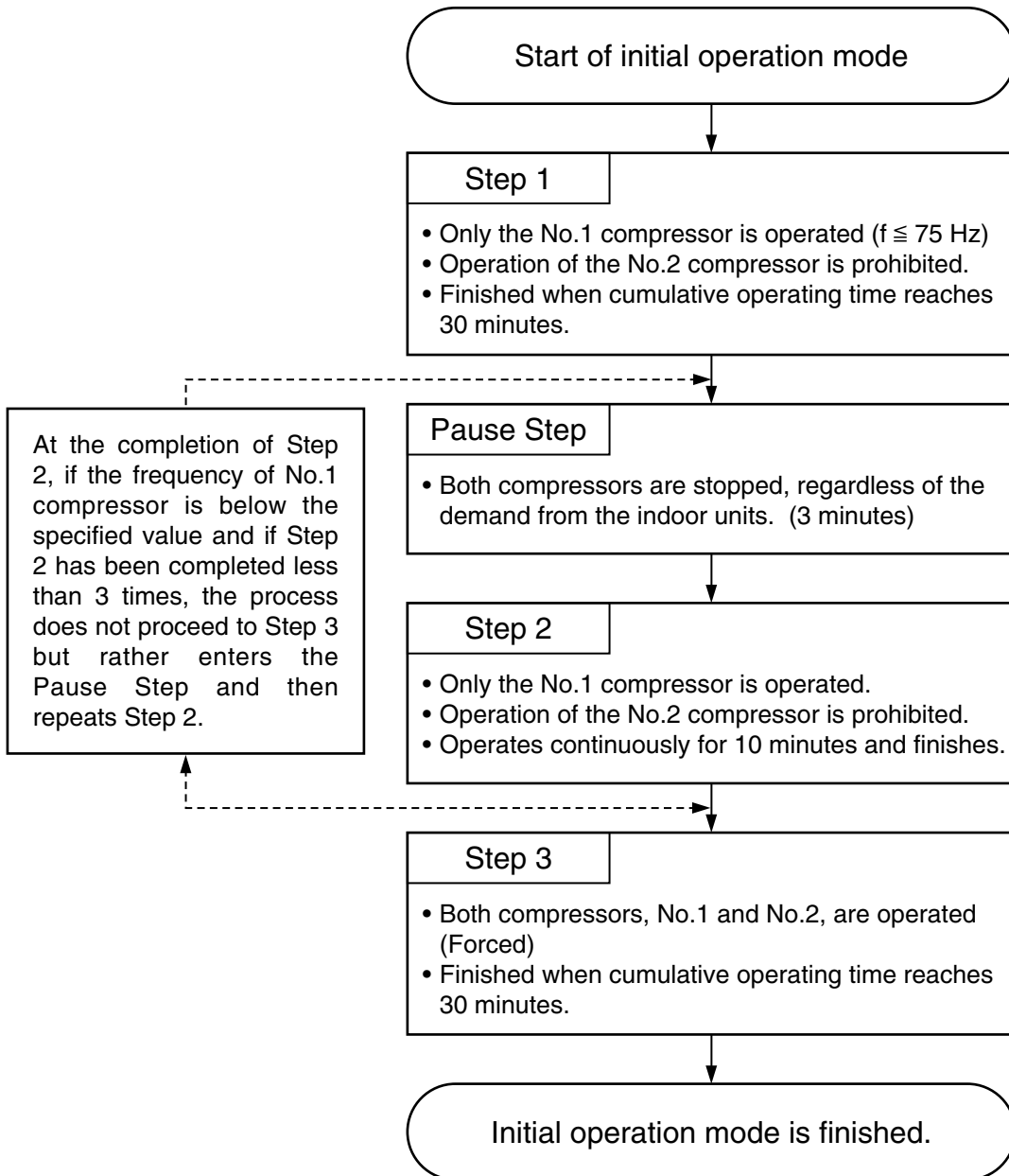

<Initial start control timing chart>

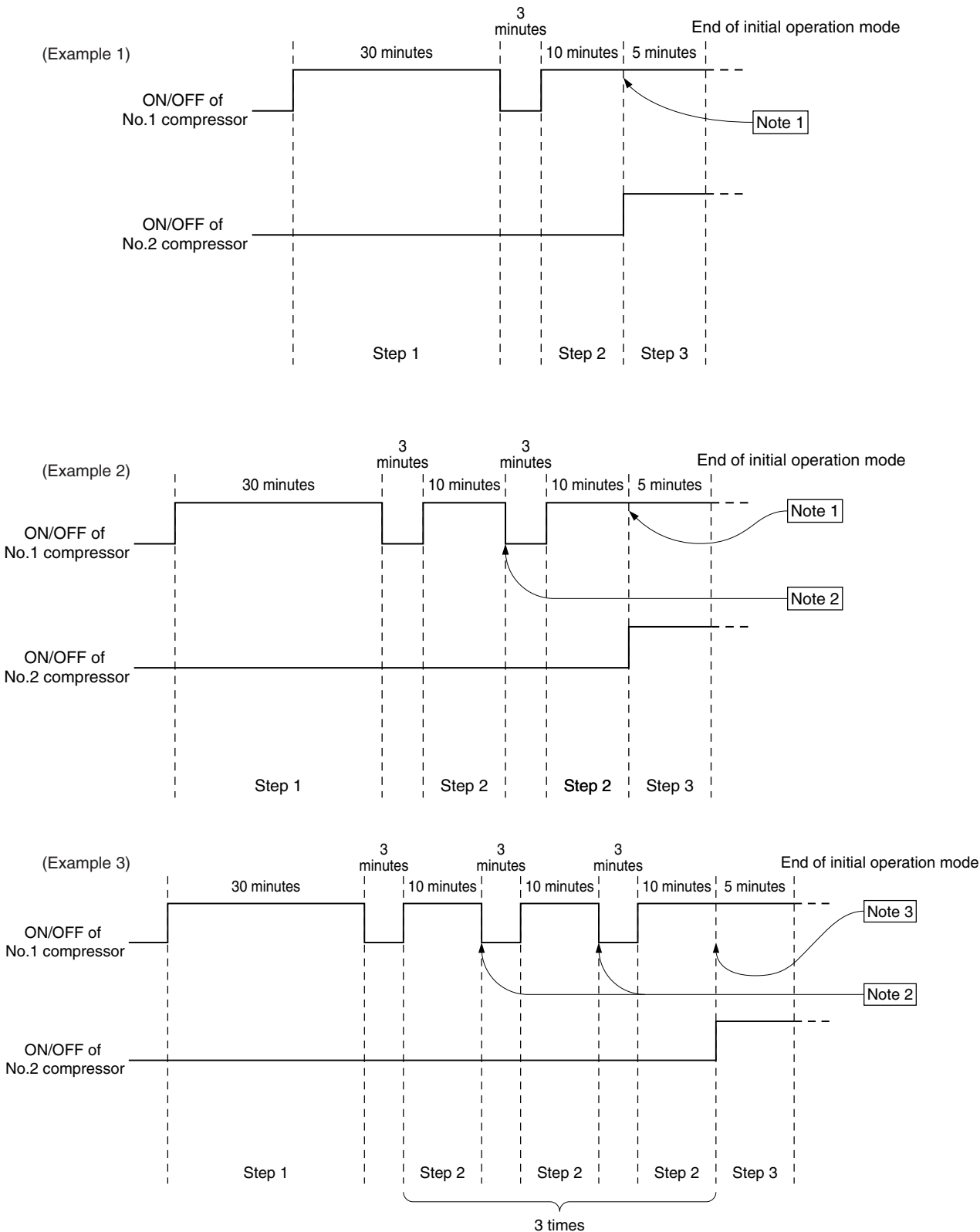

Note 1: If the frequency of No. 1 compressor is above the specified level at the end of Step 2, the mode proceeds to Step 3.

Note 2: At the completion of Step 2, if the frequency of No. 1 compressor is below the specified value and if Step 2 has been completed less than 3 times, the process does not proceed to Step 3 but rather enters the Pause Step and then repeats Step 2.

Note 3: At the completion of Step 2, if it has been completed more than 3 times, the mode will proceed to Step 3 even if the frequency of No. 1 compressor is below the specified value.

(13) Operation Mode

1) Operating modes of the indoor unit

The following five modes can be set by the remote control.

①	Cooling mode
②	Heating mode
③	Dry mode
④	Fan mode
⑤	Stop mode

2) Operating modes of the outdoor unit

The following are the 3 modes for the outdoor unit.

①	Cooling mode	All indoor units are operated in cooling mode
②	Heating mode	All indoor units are operated in heating mode
③	Stop mode	All indoor units are in fan or stop mode

Note : If the outdoor unit has been in the cooling mode and the other indoor units (in stop, fan, thermostat off) are set to the heating mode, those indoor units will not be operated and the heating indicator will be flashed on the remote controller. The reverse also applies when the outdoor unit is operated in the heating mode and the cooling indicator will be flashed on the remote controller.

(14) Emergency response operating mode

The emergency operation mode is a mode in which the unit is run in an emergency to respond to the trouble when the compressors (No. 1, No. 2) break down, making it possible to carry out a trouble reset using the remote control.

1) Starting the Emergency Operation Mode

- ① Trouble occurs (Display the trouble code root and trouble code on the remote control).
- ② Carry out trouble reset with the remote control.
- ③ If the trouble indicated in ① above is of the kind that permits emergency operation (see the table below), initiate a retry operation.
If the trouble indicated in ① above is of the kind where emergency operation is impossible (see the table below), restart operation after carrying out the previous trouble reset (without entering the emergency operation mode).
- ④ If the same trouble is detected again during the retry operation in ③ above, carry out trouble reset once more with the remote control, then try emergency operation starting corresponding to the contents of the trouble.

Table Emergency Operation Mode Patterns and Trouble Codes for which Emergency Operation is Possible or Impossible

Emergency Mode Pattern	Codes for which emergency operation is possible.	Trouble Codes for which Emergency Operation is Impossible	Action
When a No. 1 Compressor Failure Occurs	Serial transmission trouble 0403 VDC sensor/circuit trouble 4200 Breaking of overcurrent 4210 Bus voltage trouble 4220 Radiator panel overheat protection 4230 Overcurrent protection 4240 Cooling fan trouble 4260 Thermal sensor trouble (Radiator panel) 5110 IDC sensor/circuit trouble 5301	Trouble codes other than those at left.	Emergency Operation only with the No. 2 Compressor * After the retry operation, even if there is a different trouble code detected within <Inverter Trouble> at left, press the button and after resetting, start the unit by emergency operation. [Example] 4250 → Reset → Retry → 4240 → Reset → Emergency operation
When No. 2 Compressor Failure Occurs	Overcurrent protection		Emergency Operation only with the No. 1 Compressor

Caution

During emergency operation, only X marked percentage of indoor units can be operated during emergency operation. In case, more than X marked percentage of indoor units are operated, over than the percentage of indoor units would be on the stand-by mode.

	400	500
No. 1 Compressor Failure	× ≤ 48 %	× ≤ 65 %
No. 2 Compressor Failure	× ≤ 65 %	× ≤ 65 %

[1]-2 PUHY-400-500 YMF-B

(1) Initial processing

- When turning on power source, initial processing of microcomputer is given top priority.
- During initial processing, control processing corresponding to operation signal is suspended. The control processing is resumed after initial processing is completed. (Initial processing: Data processing in microcomputer and initial setting of each LEV opening, requiring approx. 2 minutes at the maximum.)

(2) Control at starting

- For 3 minutes after starting, 60 Hz is the upper frequency limit. (When only No. 1 compressor is operating.)
- 75 Hz is the upper limit within 2 hours after the power supply has been turned ON and for the 30 minutes after the compressor has started operation.
- Normal control is performed after the initial start mode (described later) has been completed.

(3) Compressor capacity control

- Variable capacitor compressor is performed by the variable capacity compressor (No. 1: inverter motor) and constant capacity compressor (No. 2: Model 500 has capacity control switching, Model 400 does not).
- In response to the required performance, the number of compressors operating, the switching of capacity control and the frequency of the variable capacitor compressor is controlled so that the evaporation temperature is between 0 and 5°C in cooling mode and that the high pressure is between 18 and 20 kg/cm²G (1.76 and 1.96 MPa) in heating mode.
- The fluctuation of the frequency of the variable capacitor compressor is as follows. It is performed at 2 Hz per second.
20 to 100 Hz (TH6 > 20°C and in cooling mode, or in heating mode)
30 to 100 Hz (TH6 < 20°C and in cooling mode)

1) No. 2 compressor operation, stopping and full-load/un-load switching

① Switching from stopping to operation of No. 2 compressor.

When the required performance cannot be obtained by only No. 1 compressor, the No. 2 compressor will be started. (On Model 500, the No. 2 compressor will be started in un-load operation.)

- Model 400: After the No. 1 compressor has reached 98 Hz, the No. 2 compressor stops → starts.
- Model 500: After the No. 1 compressor has reached 100 Hz, the No. 2 compressor stops → un-load or un-load → full-load.

② Switching from operation to stopping of No. 2 compressor.

When the required performance is exceeded when the two compressors, No. 1 and No. 2, are operating, the No. 2 compressor is stopped. (On Model 500, the No. 2 compressor will be performed in un-load operation.)

③ Switching from un-load to full-load of No. 2 compressor (Model 500 only)

When the required performance cannot be obtained by the No. 1 compressor and the No. 2 compressor operating in un-load, the No. 2 compressor will be switched to full-load operation.

④ Switching from full-load to un-load of No. 2 compressor (Model 500 only)

When the required performance is exceeded when the two compressors, No.1 and No. 2 operating in full-load, the No 2 compressor will be switched to un-load operation.

2) Pressure control

The upper limit value for the high pressure (Pd) has been set for each frequency. When this value is exceeded, the frequency is reduced every 30 seconds.

3) Discharge temperature control

The discharge temperature of the compressor (Td) is monitored during the operation. If the upper limit is exceeded, the frequency is reduced by 5 Hz.

- Control is performed every 30 seconds after 30 seconds at the compressor starting.

- The operating temperature is 124°C.

4) Compressor frequency control

① Ordinary control

The ordinary control is performed after the following times have passed.

- 30 seconds after the start of the compressor or 30 seconds after the completion of defrosting.
- 30 seconds after frequency control operation by the discharge temperature or the high pressure.

② Amount of frequency fluctuation

The amount of frequency fluctuation is controlled in response to the evaporation temperature (TH2) and the high pressure (Pd) so that it will be approached the target values.

③ Frequency control back-up by the bypass valve

Frequency control is backed-up by the turning on (opening) the bypass valve (SV4) when only the No. 1 compressor is operated at its lowest frequency.

• Cooling

After the compressor has been operated for 15 minutes and only the No. 1 compressor is operated in un-load (its lowest frequency), the bypass valve is turned ON when the evaporation temperature (TH2) is -30°C or less and turned OFF when it is -15°C or more.

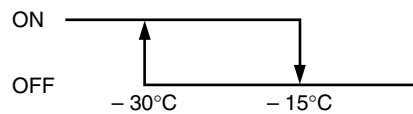

• Heating

After the compressor has been operated for 3 minutes and only the No. 1 compressor is operated in un-load (its lowest frequency), the bypass valve is turned ON when the high pressure (Pd) exceeds 25 kg/cm^2 (2.45 MPa) and turned OFF when it is 20 kg/cm^2 (1.96 MPa) or less.

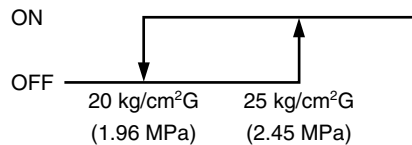

(4) Bypass - capacity control

The solenoid valves have bypass valves (SV1, SV4 and SV6) that allow bypassing of the high pressure and low pressure sides and solenoid valves (SV22 and SV32) that control the capacity control valve inside the compressor. They operate as follows.

1) Bypass valve (SV6) [SV6 is on (open)]

- As shown in the table below, control is performed by the operation and stopping of the No. 1 compressor and No. 2 compressor.

No. 1 compressor	No. 2 compressor	SV6
Stop	Stop	OFF
Operate	Stop	ON
Operate	Operate	OFF

2) Bypass solenoid valves (SV1, SV4) [Both SV1 and SV4 are on (open)]

Item	SV1		SV4	
	ON	OFF	ON	OFF
At compressor is started	ON for 4 minutes		—	
Compressor stopped during cooling or heating mode	ON		—	
After operation has been stopped	ON for 3 minutes		—	
During defrosting (*1) in Fig below)	ON		Normally ON	
During oil recovery operation	ON during oil recovery operation after continuous low-frequency compressor operation.		—	
When low pressure saturation temperature (TH2) has dropped during lower limit frequency operation(15 minutes after start)	—		TH2 < - 30°C	TH2 ≥ - 15°C.
When the high pressure (Pd) is risen up during lower limit frequency operation (3 minutes after starting)	Pd ≥ 27.5 kg/cm ² G (2.70 MPa)	Pd ≤ 24 kg/cm ² G (2.35 MPa) and after 30 seconds.	Pd ≥ 23 kg/cm ² G (2.26 MPa)	Pd ≤ 23 kg/cm ² G (2.26 MPa) and after 30 seconds
	—		ON when the high pressure (Pd) exceeds the control pressure limit.	Pd ≤ 20 kg/cm ² G (1.96 MPa)
When the discharge temperature (Td) is risen up	—		<ul style="list-style-type: none"> Td > 130°C and Pd > 20 kg/cm²G (1.96 MPa) or TH2 < - 10°C	Td ≤ 115°C

* Example of operation of SV1

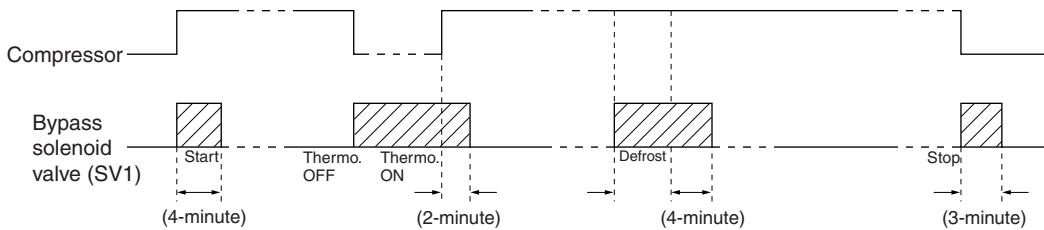

3) Capacity control solenoid valve (SV22, SV32) *Model 500 only.

• Operation of solenoid valve

Solenoid valve \ Status	SV22		SV32	
	Coil	Valve	Coil	Valve
Full-load (Operating at 100 % capacity)	OFF	Open	OFF	Closed
Un-load (Capacity control operation)	ON	Closed	ON	Open

- SV22 and SV32 stand for SV2 and SV3 of the No. 2 compressor.

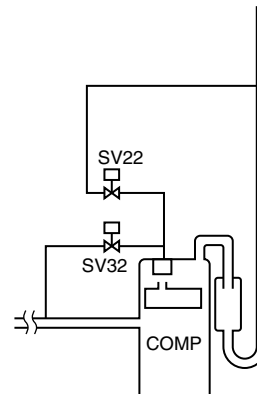

(5) Oil return control (Electronic expansion valve (SLEV))

- The amount of opening of the oil-return LEV (SLEV) is determined as follows: in cooling, by the operating capacity of the No. 1 compressor and the ambient temperature; in heating, by the operating capacity of the No. 1 compressor.
- It is opened (64) when both compressors are stopped and started for 10 minutes. (Upper limit of LEV opening is $S_o = 388$ pulse.)
- $S_{LEV} = 0$ when the No. 1 compressor is stopped.

(6) Sub-cool coil control (Electronic expansion valve (LEV1))

- The sub-cool coil control provides control every 30 seconds to keep the super heat volume from the temperature of the inlet/outlet of the sub-cool coil (TH8, TH9) within a stable range (2 to 4 degrees).
- It controls by correcting the amount of opening according to the temperature of the inlet/outlet of the sub-cool coil (TH5, TH7), the high pressure (Pd) and discharge temperature.
- It is closed (0) in heating or when the compressor is stopped.
- It has a fixed opening (480) in defrosting.
- During normal control, the operating range is 46 to 480.

(7) Defrosting control

1) Start of defrosting

- After there has been heating operation for 50 minutes or after 90 minutes has passed and a piping temperature (TH5) of 0°C or less is detected for a preset time, defrosting begins.
- When 10 minutes has passed since the compressor began operation or if 10 minutes has passed since recovery from defrosting, setting the forced defrosting switch (Dip SW2-7) to starts forced defrosting.

2) End of defrosting

- Defrosting ends when 15 minutes has passed since the start of defrosting or when the piping temperature (TH5) becomes 7°C or more. (Note that if defrost-prohibited time has been set to 90 minutes, the defrost-prohibit time will be 50 minutes following a 15 minute timed recovery.)
- Ending the defrosting is prohibited for 2 minutes after the start of defrosting. (Note that the defrosting operation will be ended if the piping temperature exceeds 20°C within 2 minutes of the start of defrosting.)

3) Defrost-prohibit

- Defrosting is not performed for 10 minutes after the start of compressor operation and during oil recovery mode.

4) Abnormalities during defrosting

- If an error is detected during defrosting, the defrosting is stopped and the defrost-prohibit time is set to 20 minutes by the compressor cumulative operating time.

- 5) Change in number of operating indoor units while defrosting
 - If the number of indoor units changes while the outdoor unit is defrosting, the defrosting operation continues. Once defrosting has ended, control for changing the number of units is performed.
 - If the indoor unit is stopped while the outdoor unit is defrosting or if the thermostat is set to off, the defrosting operation continues. Once defrosting has ended, the unit is stopped.
- 6) Number of compressors operating during defrosting
 - The number of compressors operating during defrosting is always two.

(8) Control of liquid level detecting heater

Detect refrigerant liquid level in accumulator, and heat refrigerant with liquid level heater for judging refrigerant amount. 7 steps of duty control is applied to liquid level heater depending on frequency and outdoor air temperature, 1 minute after starting compressor.

(9) Judgement and control of refrigerant amount

- Judge refrigerant amount by detecting refrigerant liquid surface accumulator.

1) Judgement of accumulator liquid level

- Return refrigerant from accumulator liquid level detecting circuit to compressor inlet pipe, detect piping temperature, and judge liquid level.

When heated with heater, liquid refrigerant temperature is almost equal to low pressure saturation temperature, and gas refrigerant temperature is a little higher than low pressure saturation temperature. By comparing these temperature A in accumulator inlet portion, refrigerant liquid level can be judged.

Accumulator liquid level is judged in 3 steps as shown in the figure, from temperature A and liquid level detecting temperatures (TH3, TH4). After deciding refrigerant status (Liquid: TH3 and TH4 are TH2 + 5°C or less, Gas: TH3 and TH4 are TH2 + 5°C or more), judge liquid level by comparing TH3 and TH4.

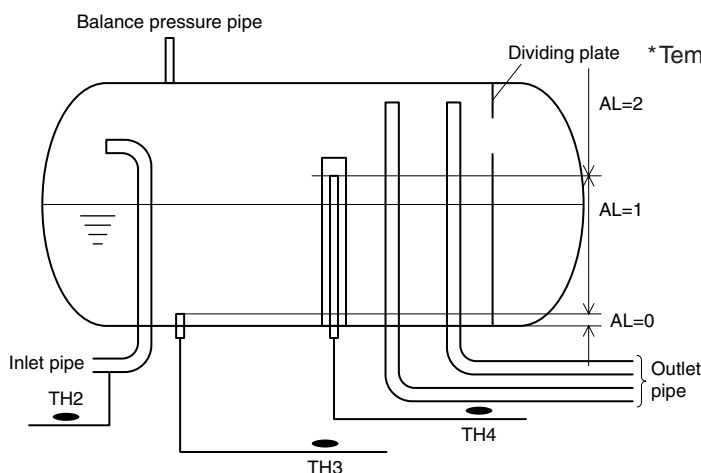

* Temperature A: low pressure saturation temperature (TH2).

- Judgement by the AL is at best only a rough guideline. Please do not add refrigerant based on the AL reading alone.

2) Control of liquid level detection

① Prohibition of liquid level detection

Liquid level is detected in normal conditions except for the following;

(Cooling)

- For 6 minutes after starting unit, and during unit stopping.

(Heating)

- For 6 minutes after starting unit, and during unit stopping.

- During defrosting.

- For 10 minutes after refrigerant recovery.

(Note that liquid level determination is being performed even when liquid level detection is being disregarded.)

② In case AL = 2 is detected for 3 consecutive minutes during liquid level detection (control at excessive refrigerant replenishment and trouble mode)

- Changed to intermittent fault check mode preceded by 3 minutes restart prevention. But it is not abnormal when the discharge SH is high. Error stop is observed when trouble is detected again in the same intermittent fault check mode (for 30 minutes after unit stops for intermittent fault check).

- When turning on liquid level trouble ignore switch (SW2-4), error stop is not observed, and 3 minutes restart prevention by intermittent fault check mode is repeated. However, LED displays overflow.

(Turning SW2-4 on makes the error of TH6 < outdoor air sensor > ineffective.)

③ When operation mode shows "Stop," excessive or insufficient refrigerant display and excessive or insufficient refrigerant ignore display are extinguished.

(10) Refrigerant recovery control

Refrigerant recovery is conducted to prevent refrigerant from accumulating in the stopped unit (fan unit), the unit under cooling mode and that with heating thermostat being turned off.

1) Start of refrigerant recovery

① Refrigerant recovery is started when the two items below are fully satisfied.

- 30 minutes has passed after finishing refrigerant recovery.
- The level detector detects AL = 0 for 3 minutes continuously, or the discharge SH is high.

2) Refrigerant recovery operation

- Refrigerant is recovered by opening LEV of the objective indoor units (indoor units under stop. fan, and cooling modes, and that with heating thermostat being turned off) for 30 seconds.

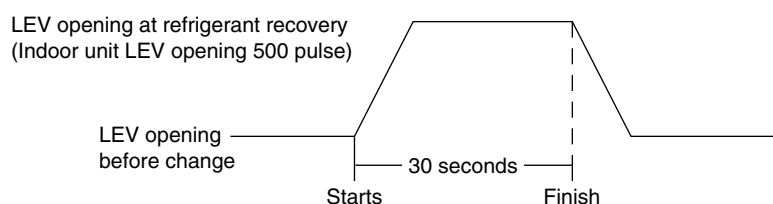

- The regular capacity control of the outdoor unit and the regular LEV control of the indoor unit are not applied during refrigerant recovery operation, but are fixed with the value before the recovery operation. These controls will be conducted one minute after finishing the recovery operation.
- Defrosting operation is prohibited during the recovery operation, and it will be conducted after finishing the recovery operation

(11) Outdoor unit heat exchanger capacity control

1) Control method

- In order to stabilize the evaporation temperature during cooling and the high-pressure pressure during heating that are required in response to performance needs, the capacity of the outdoor heat exchanger is controlled by regulating the fan volume of the outdoor unit by phase control and controlling the number of fans and by using the solenoid valves.

2) Control

- When both of the compressors are stopped, the fans for the outdoor units are also stopped.
- The fans operate at full speed for 10 seconds after starting.
- The fans for the outdoor unit are stopped during defrosting.

3) Capacity control pattern

Operating mode	Capacity control pattern	Heat exchanger capacity	No. of fans	Phase control	Notes
Cooling	①	50 %	1	10 to 100 %	21S4bON SV5bON
	②	100 %	2	10 to 100 %	21S4bOFF SV5bOFF
Heating	①	100 %	2	10 to 100 %	21S4bON SV5bOFF
Defrosting	①	100 %	0	0 %	21S4bOFF SV5bOFF

Note 1: When there is conductivity at SV5b, it is open. When there is no conductivity at SV5b, it is closed.

Note 2: When the unit is stopped, and SV5b are open.

(12) Control at initial starting

- When the ambient temperature is low (5°C or less in cooling and – 5°C or less in heating), initial starting will be performed if the unit is started within 4 hours of the power being turned on.
- The following initial start mode will be performed when the unit is started for the first time after the power has been turned on.

<Flow chart of initial start mode>

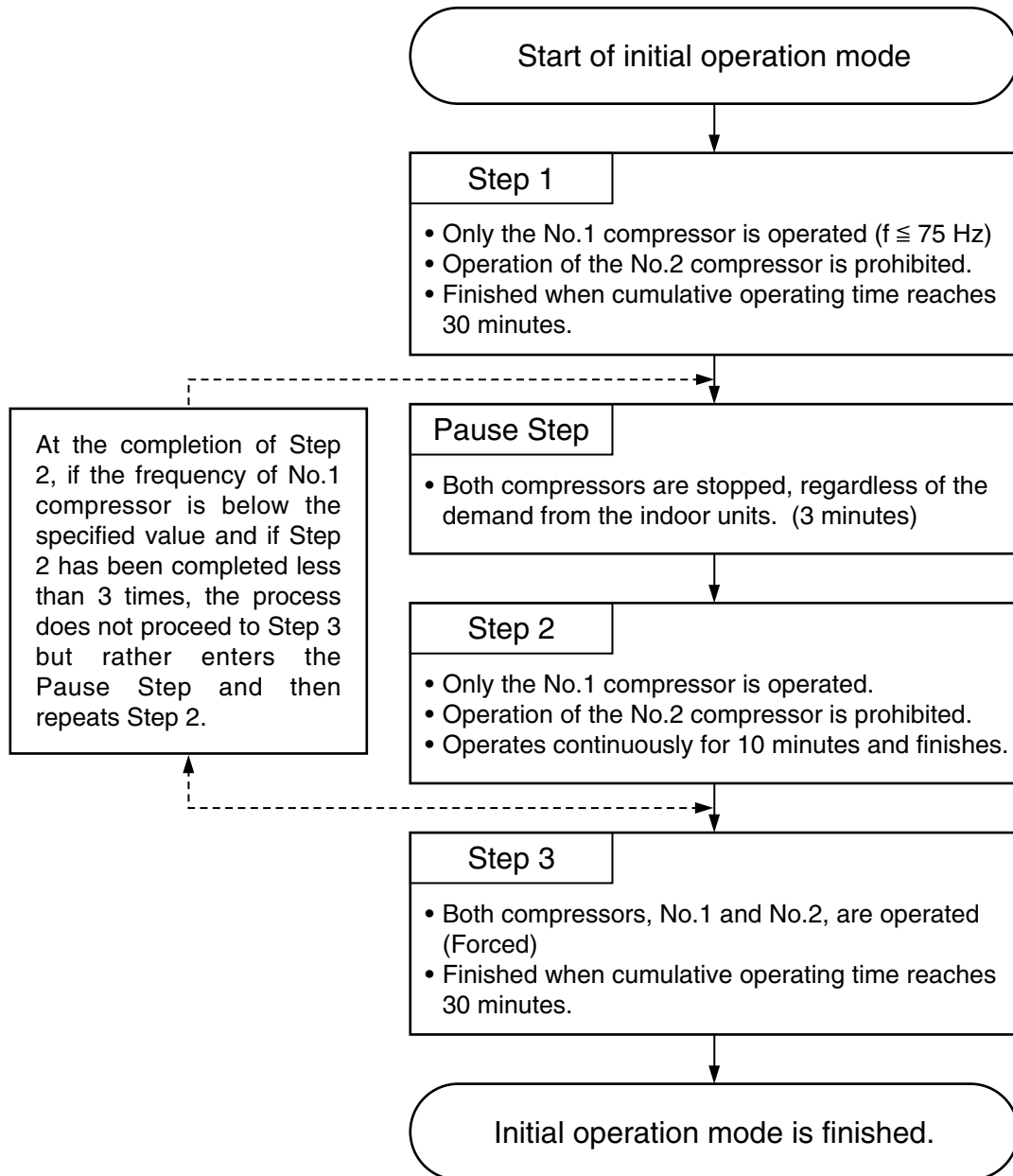

<Initial start control timing chart>

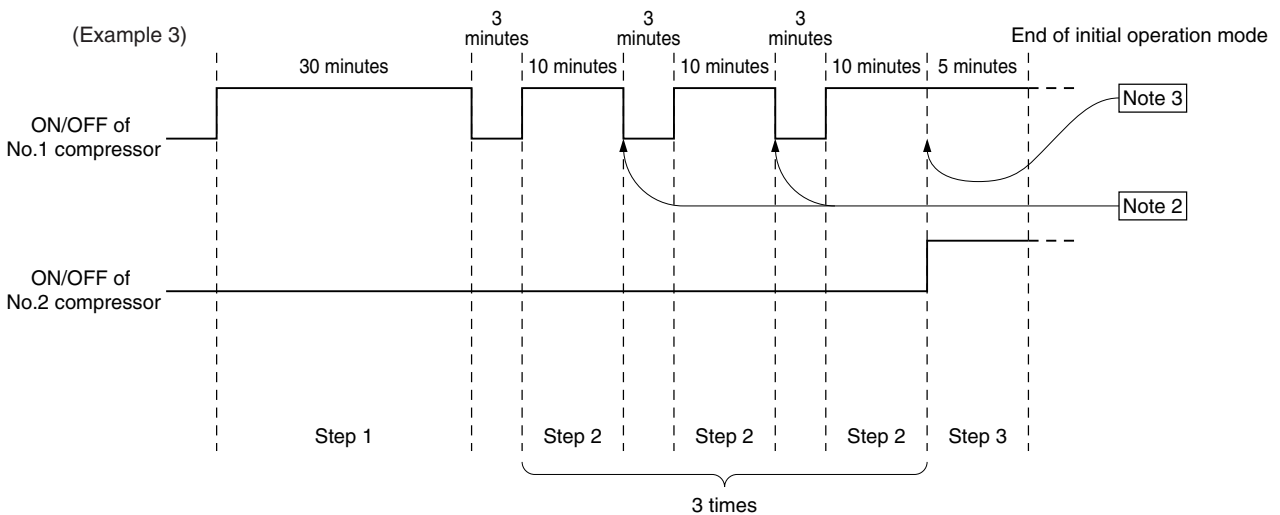
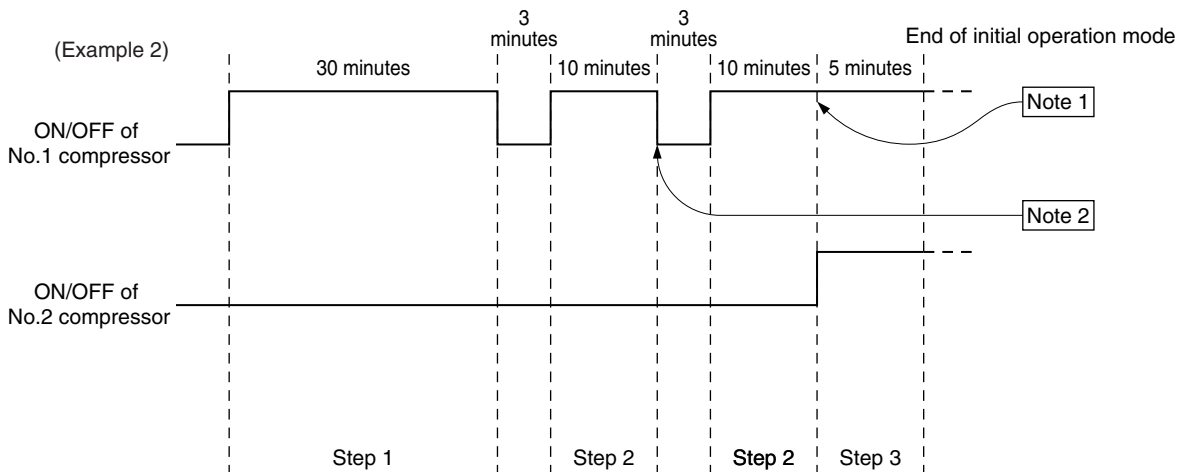
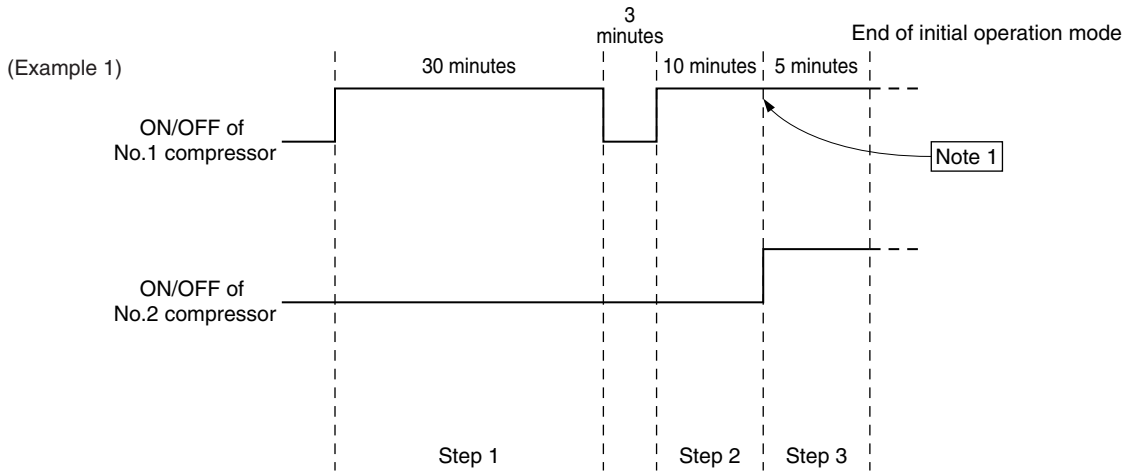

Note 1: If the frequency of No. 1 compressor is above the specified level at the end of Step 2, the mode proceeds to Step 3.

Note 2: At the completion of Step 2, if the frequency of No. 1 compressor is below the specified value and if Step 2 has been completed less than 3 times, the process does not proceed to Step 3 but rather enters the Pause Step and then repeats Step 2.

Note 3: At the completion of Step 2, if it has been completed more than 3 times, the mode will proceed to Step 3 even if the frequency of No. 1 compressor is below the specified value.

(13) Operation Mode

1) Operating modes of the indoor unit

The following five modes can be set by the remote control.

①	Cooling mode
②	Heating mode
③	Dry mode
④	Fan mode
⑤	Stop mode

2) Operating modes of the outdoor unit

The following are the 3 modes for the outdoor unit.

①	Cooling mode	All indoor units are operated in cooling mode
②	Heating mode	All indoor units are operated in heating mode
③	Stop mode	All indoor units are in fan or stop mode

Note: If the outdoor unit has been in the cooling mode and the other indoor units (in stop, fan, thermostat off) are set to the heating mode, those indoor units will not be operated and the heating indicator will be flashed on the remote controller. The reverse also applies when the outdoor unit is operated in the heating mode and the cooling indicator will be flashed on the remote controller.

(14) Emergency response operating mode

The emergency operation mode is a mode in which the unit is run in an emergency to respond to the trouble when the compressors (No. 1, No. 2) break down, making it possible to carry out a trouble reset using the remote control.

1) Starting the Emergency Operation Mode

- ① Trouble occurs (Display the trouble code root and trouble code on the remote control).
- ② Carry out trouble reset with the remote control.
- ③ If the trouble indicated in ① above is of the kind that permits emergency operation (see the table below), initiate a retry operation.
If the trouble indicated in ① above is of the kind where emergency operation is impossible (see the table below), restart operation after carrying out the previous trouble reset (without entering the emergency operation mode).
- ④ If the same trouble is detected again during the retry operation in ③ above, carry out trouble reset once more with the remote control, then try emergency operation starting corresponding to the contents of the trouble.

Table Emergency Operation Mode Patterns and Trouble Codes for which Emergency Operation is Possible or Impossible

Emergency Mode Pattern	Codes for which emergency operation is possible.	Trouble Codes for which Emergency Operation is Impossible	Action
When a No. 1 Compressor Failure Occurs	Serial transmission trouble 0403 VDC sensor/circuit trouble 4200 Breaking of overcurrent 4210 Bus voltage trouble 4220 Radiator panel overheat protection 4230 Overcurrent protection 4240 Cooling fan trouble 4260 Thermal sensor trouble (Radiator panel) 5110 IDC sensor/circuit trouble 5301	Trouble codes other than those at left.	Emergency Operation only with the No. 2 Compressor * After the retry operation, even if there is a different trouble code detected within <Inverter Trouble> at left, press the button and after resetting, start the unit by emergency operation. [Example] 4250 → Reset → Retry → 4240 → Reset → Emergency operation
When No. 2 Compressor Failure Occurs	Overcurrent protection		Emergency Operation only with the No. 1 Compressor

Caution

During emergency operation, only × marked percentage of indoor units can be operated during emergency operation. In case, more than × marked percentage of indoor units are operated, over than the percentage of indoor units would be on the stand-by mode.

	400	500
No. 1 Compressor Failure	× ≤ 48 %	× ≤ 65 %
No. 2 Compressor Failure	× ≤ 65 %	× ≤ 65 %

[1]- 3 PUHY-P600-650-700-750 YSMF-B

(1) Initial processing

- When turning on power source, initial processing of microcomputer is given top priority.
- During initial processing, control processing corresponding to operation signal is suspended. The control processing is resumed after initial processing is completed. (Initial processing: Data processing in microcomputer and initial setting of each LEV opening, requiring approx. 2 minutes at the maximum.)

(2) Control at starting

- At startup, variable capacity unit operations will start first.
- For 3 minutes after starting, 60 Hz is the upper frequency limit. (When only No. 1 compressor is operating.)
- 75 Hz is the upper limit for the 30 minutes after the compressor has started operation.
- Normal control is performed after the initial start mode (described later) has been completed.

(3) Compressor capacity control

- Compressor is performed by the variable capacity compressor on the variable capacity unit (No. 1: inverter motor) and constant capacity compressor (No. 2: It has capacity control switching).
- In response to the required performance, the number of compressors operating, the switching of capacity control and the frequency of the variable capacitor compressor is controlled so that the evaporation temperature is between -2 and -6°C in cooling mode and that the condensation temperature is 49°C in heating mode.
- The fluctuation of the frequency of the variable capacitor compressor is as follows. It is performed at 3 Hz per second.
 - 20 to 100 Hz (TH6 $> 20^{\circ}\text{C}$ in cooling mode, or in heating mode)
 - 30 to 100 Hz (TH6 $< 20^{\circ}\text{C}$ in cooling mode)

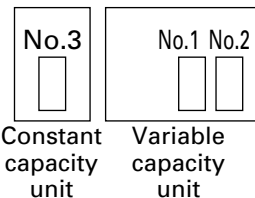

1) No. 2 compressor operation, stopping and full-load/un-load switching

① Switching from stop to run of No. 2 compressor.

When the required performance cannot be obtained by only No. 1 compressor, the No. 2 compressor will be started. (The No. 2 compressor will be started in un-load operation.)

- After the No. 1 compressor has reached 100 Hz, the No. 2 compressor stops → un-load or un-load → full-load.

② Switching from run to stopping of No. 2 compressor.

When the required performance is exceeded when the two compressors, No. 1 and No. 2, are operating, the No. 2 compressor is stopped. (The No. 2 compressor will be performed in un-load operation.)

③ Switching from un-load to full-load of No. 2 compressor.

When the required performance cannot be obtained by the No. 1 compressor and the No. 2 compressor operating in un-load, the No. 2 compressor will be switched to full-load operation.

④ Switching from full-load to un-load of No. 2 compressor.

When the required performance is exceeded when the two compressors, No.1 and No. 2 operating in full-load, the No 2 compressor will be switched to un-load operation.

2) No. 3 compressor operation/stopping.

① Switching No. 3 compressor from stopping to operation

When the required performance cannot be obtained with only the No. 1 and No. 2 variable capacity unit compressors, the constant capacity unit No. 3 compressor will be started.

- *The No. 3 compressor is equipped with a capacity control switching function. It starts with un-load operation in the initial start mode and during defrosting, and starts in full-load operation at all other times.

② Switching No. 3 compressor from operation to stopping

When the required performance is exceeded with the No. 1 and No. 2 variable capacity unit compressors and the constant capacity unit No. 3 compressor in operation, the No. 3 compressor will be stopped.

3) Pressure control

- The upper limit value for the high pressure (Pd) has been set for each frequency. When this value is exceeded, the frequency is reduced every 30 seconds.
- While the constant capacity unit is in operation, if the high pressure (63HS) value exceeds 26 kg/cm²G (2.55 MPa), the constant capacity unit compressor will be stopped.

4) Discharge temperature control

- ① The discharge temperature of the compressor (Variable capacity unit: TH11, TH12, Constant capacity unit: TH11) is monitored during the operation. If the upper limit is exceeded, the frequency is reduced by 5 Hz.
 - Control is performed every 30 seconds after 30 seconds at the compressor starting.
 - The operating temperature is 124°C (No.1 compressor) or 115°C (No. 2, 3 compressor).
- ② While the constant capacity unit is in operation, if the constant capacity unit discharge temperature (TH11) exceeds 115°C, the constant capacity unit compressor will be stopped.

5) Compressor frequency control

① Ordinary control

The ordinary control is performed after the following times have passed.

- 30 seconds after the start of the compressor or 30 seconds after the completion of defrosting.
- 30 seconds after frequency control operation by the discharge temperature or the high pressure.

② Amount of frequency fluctuation

The amount of frequency fluctuation is controlled in response to the evaporation temperature (Te) and the condensation temperature (Tc) so that it will be approached the target values.

③ Frequency control back-up by the bypass valve

Frequency control is backed-up by the turning on (opening) the bypass valve (SV4) when only the No. 1 compressor is operated at its lowest frequency.

• Cooling

After the compressor has been operated for 15 minutes and only the No. 1 compressor is operated in un-load (its lowest frequency), the bypass valve is turned ON when the low pressure (63LS) is 1.0 kg/cm²G (0.098 MPa) or less and turned OFF when it is 2.0 kg/cm²G (0.196 MPa) or more.

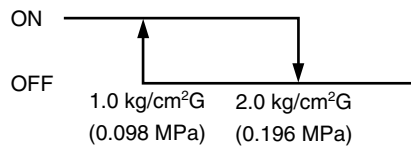

• Heating

After the compressor has been operated for 3 minutes and only the No. 1 compressor is operated in un-load (its lowest frequency), the bypass valve is turned ON when the high pressure (Pd) exceeds 27 kg/cm² (2.65 MPa) and turned OFF when it is 24 kg/cm² (2.35 MPa) or less.

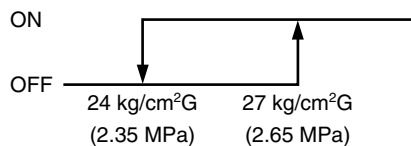

(4) Bypass - capacity control

The solenoid valves have bypass valves (SV1, SV4 and SV6) that allow bypassing of the high pressure and low pressure sides and solenoid valves (SV22 and SV32) that control the capacity valve inside the compressor. Those operation are as follows.

○ : Installed × : Not Installed

	SV1	SV4	SV6	SV22, SV32
Variable Capacity Unit	○	○	○	○
Constant Capacity Unit	○	○	×	○
Use	Maintenance of high-pressure/low-pressure, discharge temperature			Controls the compressors' internal volume control valve.

* The compressor of constant capacity unit starts in un-load operation in the initial start mode and during defrosting only, and starts in full-load operation at all other times by SV22,23 switching.
Normally compressor capacity control is not performed.

1) Bypass Valve (SV6) (SV6 is open when ON, variable capacity unit only)

- The valve is set as follows according to whether the variable capacity unit No. 1 and No. 2 compressors are operating.

No. 1 Compressor	No. 2 Compressor	SV6
Stopped	Stopped	OFF
Operating	Stopped	ON
Operating	Operating	OFF

2) Bypass solenoid valves (SV1, SV4) [Both SV1 and SV4 are on (open)]
 <Variable capacity unit>

Item	SV1		SV4	
	ON	OFF	ON	OFF
At compressor is started	ON for 4 minutes		—	
Compressor stopped during cooling or heating mode	ON		—	
After operation has been stopped	ON for 3 minutes		—	
During defrosting ((*1) in Fig below)	ON		Normally ON	
During oil recovery operation	ON during oil recovery operation after continuous low-frequency compressor operation.		—	
When low pressure (Ps) has dropped during lower limit frequency operation(15 minutes after start)	—		Ps < 1.0 kg/cm ² G (0.098 MPa)	Ps ≥ 2.0 kg/cm ² G (0.196 MPa)
When the high pressure (Pd) is risen up during lower limit frequency operation (3 minutes after starting)	Pd ≥ 27.5 kg/cm ² G (2.70 MPa)	Pd ≤ 24 kg/cm ² G (2.35 MPa) and after 30 seconds.	Pd ≥ 27 kg/cm ² G (2.65 MPa)	Pd ≤ 24 kg/cm ² G (2.35 MPa) and after 30 seconds
	—		ON when the high pressure (Pd) exceeds the control pressure limit.	Pd ≤ 20 kg/cm ² G (1.96 MPa)
When the discharge temperature (Td) is risen up	—		• Td > $\begin{cases} 130^{\circ}\text{C} & \text{(No. 1 compressor)} \\ 115^{\circ}\text{C} & \text{(No. 2 compressor)} \end{cases}$ and • Pd > 20 kg/cm ² G (1.96 MPa) or Ps < 3.5 kg/cm ² G (0.34 MPa)	Td ≤ $\begin{cases} 115^{\circ}\text{C} & \text{(No. 1 compressor)} \\ 100^{\circ}\text{C} & \text{(No. 2 compressor)} \end{cases}$

* Example of operation of SV1

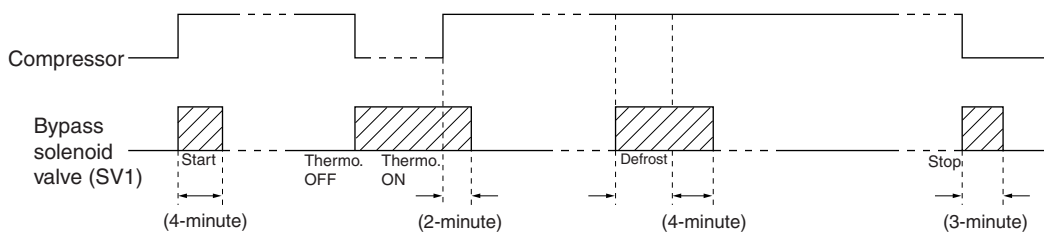

<Constant Capacity Unit>

Item	SV1		SV4	
	ON	OFF	ON	OFF
At compressor is started	ON for 4 minutes		—	
After thermostat reset or 3 minutes after startup	ON for 4 minutes		—	
Compressor stopped during cooling or heating mode	ON for 3 minutes		—	
After operation has been stopped	ON for 3 minutes		—	
During defrosting ((*1) in Fig below)	ON during normal operation		—	
When low pressure (63LS) has dropped	Low pressure (63LS) < 1.0 kg/cm ² G (0.098 MPa)	Low pressure (63LS) ≥ 1.5 kg/cm ² G (0.147 MPa)	—	—
When the high pressure (Pd) is risen up	Pd ≥ 27.5 kg/cm ² G (2.70 MPa)	Pd ≤ 24 kg/cm ² G (2.35 MPa) and after 30 seconds	—	—
When the discharge temperature (Td) is risen up.	When the discharge temperature > 110°C and high pressure (Pd) > 20 kg/cm ² G (1.96 MPa) or low pressure (63LS) < 2.5 kg/cm ² G (0.245 MPa).	When the discharge temperature ≤ 105°C	—	—
When the high pressure (Pd) is fallen up.	—		In heating mode, at starting and low volume of indoor unit, if high pressure (Pd) < 12 kg/cm ² G (1.18 MPa) and low pressure (Ps) < 1.0 kg/cm ² G (0.098 MPa)	When the high pressure (Pd) ≥ 13 kg/cm ² G (1.27 MPa) and after 30 minutes of operation.

* Example of SV1 operation

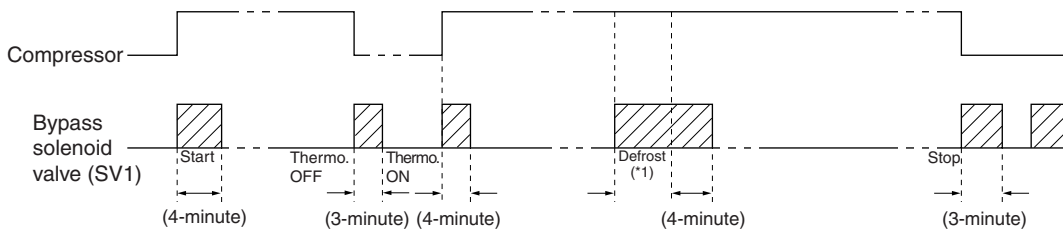

3) Capacity control solenoid valve (SV22, SV32)

• Operation of solenoid valve

Solenoid valve	SV22		SV32	
	Coil	Valve	Coil	Valve
Full-load (Operating at 100 % capacity)	OFF	Open	OFF	Closed
Un-load (Capacity control operation)	ON	Closed	ON	Open

- SV22 and SV32 stand for SV2 and SV3 of the No. 2, No. 3 compressor.

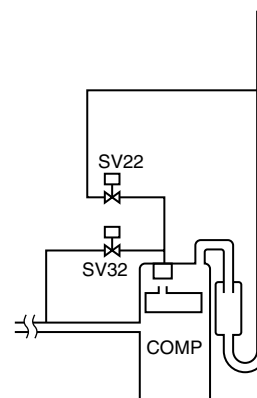

(5) Oil return control (Electronic expansion valve (SLEV); Variable Capacity Unit only)

- The amount of opening of the oil-return LEV (SLEV) is determined as follows: in cooling, by the operating capacity of the No. 1 compressor and the ambient temperature; in heating, by the operating capacity of the No. 1 compressor.
- It is opened (64) when both compressors are stopped and started for 10 minutes. (Upper limit of LEV opening is So = 388 pulse.)
- SLEV = 0 when the No. 1 compressor is stopped.

(6) Sub-cool coil control (Electronic expansion valve (LEV1))

- The sub-cool coil control provides control every 30 seconds to keep the super heat volume from the temperature of the inlet/outlet of the sub-cool coil (TH8, TH9) within a stable range (2 to 4 degrees).
- It controls by correcting the amount of opening according to the temperature of the inlet/outlet of the sub-cool coil (TH5, TH7), the high pressure (Pd) and discharge temperature.
- It is closed (0) in heating or when the compressor is stopped.
- It has a fixed opening (480) in defrosting.
- During normal control, the operating range is 46 to 480 (Variable capacity unit), 46 to 300 (Constant capacity unit).

(7) Defrosting control

Defrosting operation controls vary depending on the state of operations before defrosting begins.

		Defrost 1 - ①	Defrost 1 - ②	Defrost 2
State of operations before defrosting	Variable capacity unit	Operating	Operating	Operating
	Constant capacity unit	Operating	Stopped	Stopped
Defrosting operation control	Variable capacity unit	Defrost	Defrost	Defrost
	Constant capacity unit	Defrost	Defrost *1	Stopped *2
	Indoor unit LEV	Full open		Full closed

*1 When the cumulative operating time of the constant capacity unit compressor \geq 30 minutes.

*2 When the cumulative operating time of the constant capacity unit compressor < 30 minutes.

1) Start of defrosting

① Defrost 1 - ①, ②

- After there has been heating operation for 50 minutes and a piping temperature (TH5) of -8°C or less is detected for a preset time in either the variable or constant capacity units, defrosting starts.

② Defrost 2

- After there has been heating operation for 50 minutes, and a piping temperature of (TH5) of -8°C or less is detected for a preset time in the variable capacity unit, defrosting starts.

③ Forced Defrosting

- When 10 minutes has passed since the compressor began operation, or if 10 minutes has passed since recovery from defrosting, setting the forced defrosting switch (DIPSW2-7) to ON starts forced defrosting.

2) End of Defrosting

① Defrost 1 - ①, ②

- Defrosting ends when 15 minutes have passed since the start of defrosting, or when a piping temperature (TH5) of 7°C or more is detected for 2 minutes or longer in both the variable and constant capacity units.

② Defrost 2

- Defrosting ends when 15 minutes have passed since the start of defrosting, or when a piping temperature (TH5) of 8°C or more is detected for 2 minutes or longer in the variable capacity unit.

* Ending the defrosting is prohibited for 2 minutes after the start of defrosting. (Note that the defrosting operation will be stopped if the piping temperature exceeds 20°C or if the high pressure (Pd) exceeds $20\text{ kg/cm}^2\text{G}$ (1.96 MPa .)

3) Defrost-prohibit

- Defrosting is not performed for 10 minutes after the start of compressor operation and during oil recovery mode.

4) Abnormalities during defrosting

- If an error is detected during defrosting, the defrosting is stopped and the defrost-prohibit time is set to 20 minutes by the compressor cumulative operating time.

- 5) Change in number of operating indoor units while defrosting
 - If the number of indoor units changes while the outdoor unit is defrosting, the defrosting operation continues. Once defrosting has ended, control for changing the number of units is performed.
 - If the indoor unit is stopped while the outdoor unit is defrosting or if the thermostat is set to off, the defrosting operation continues. Once defrosting has ended, the unit is stopped.
- 6) Number of compressors operating during defrosting
 - The number of compressors operating during defrosting is three in defrost 1 - ① or ②, two in defrost 2.

(8) Control of liquid level detecting heater

Detect refrigerant liquid level in accumulator, and heat refrigerant with liquid level heater for judging refrigerant amount. 7 steps of duty control is applied to liquid level heater depending on frequency and outdoor air temperature, 1 minute after starting compressor.

(9) Judgement and control of refrigerant amount

- Judge refrigerant amount by detecting refrigerant liquid surface accumulator.

1) Judgement of accumulator liquid level

- Return refrigerant from accumulator liquid level detecting circuit to compressor inlet pipe, detect piping temperature, and judge liquid level.

When heated with heater, liquid refrigerant temperature is almost equal to low pressure saturation temperature, and gas refrigerant temperature is a little higher than low pressure saturation temperature. By comparing these temperatures A in accumulator inlet portion, refrigerant liquid level can be judged.

Accumulator liquid level is judged in 3 steps as shown in the figure, from temperature A and liquid level detecting temperatures (TH3, TH4). After deciding refrigerant status (Liquid: TH3 and TH4 are TH2 + 9°C or less, Gas: TH3 and TH4 are TH2 + 9°C or more), judge liquid level by comparing TH3 and TH4.

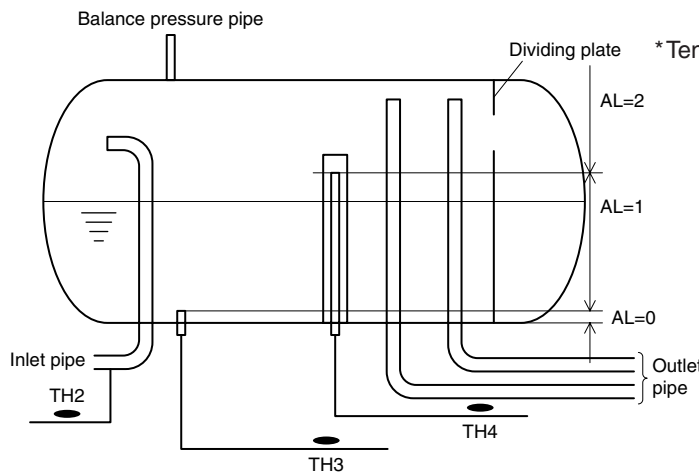

*Temperature A: low pressure saturation temperature.
 { Variable capacity unit; TH2
 Constant capacity unit; Saturation temperature of 63LS

- Judgement by the AL is at best only a rough guideline. Please do not add refrigerant based on the AL reading alone.

2) Control of liquid level detection

① Prohibition of liquid level detection

Liquid level is detected in normal conditions except for the following;

(Cooling)

- For 6 minutes after starting unit, and during unit stopping.

(Heating)

- For 6 minutes after starting unit, and during unit stopping.

- During defrosting.

- For 10 minutes after refrigerant recovery.

(Note that liquid level determination is being performed even when liquid level detection is being disregarded.)

② In case AL = 2 is detected for 3 consecutive minutes during liquid level detection (control at excessive refrigerant replenishment and trouble mode)

- Changed to intermittent fault check mode preceded by 3 minutes restart prevention. But it is not abnormal when the discharge SH is high. Error stop is observed when trouble is detected again in the same intermittent fault check mode (for 30 minutes after unit stops for intermittent fault check).

- When turning on liquid level trouble ignore switch (SW2-4), error stop is not observed, and 3 minutes restart prevention by intermittent fault check mode is repeated. However, LED displays overflow.

(Turning SW2-4 on makes the error of TH6 < outdoor air sensor > ineffective.)

③ When operation mode shows "Stop," excessive or insufficient refrigerant display and excessive or insufficient refrigerant ignore display are extinguished.

(10) Liquid Distribution Control (electronic expansion valve (LEV2) constant capacity unit only)

- Liquid distribution control refers to the process by which liquid refrigerant returning from the constant and variable capacity units during heating is equally distributed, and the opening of the constant capacity unit LEV2 is adjusted so that there is no deficiency of liquid refrigerant in the accumulator of each unit.
- ① Distribution occurs during heating operations when both the variable and constant capacity units are in operation. When the constant capacity unit is stopped, the LEV2 opening = 60.
- ② The LEV2 opening is set to a standard which varies depending on the current operation frequency.
- ③ The levels of the superheating level (SH1) of the variable capacity unit temperature A and TH10 (whichever temperature is higher) and the accumulator liquid level (AL1) are compared to the superheating level (SH2) of the constant capacity unit temperature A and TH10a and the accumulator liquid level (AL2) to correct the standard opening of the LEV2 in ② above.

* Temperature A: low pressure saturation temperature.

Chart: Corrections to the Standard LEV2 Opening

	Superheating Level		Constant Capacity Unit			
			SH2 > 7		SH2 ≤ 7	
		Accumulator Level	AL = 0 or 1	AL = 2	AL = 0 or 1	AL = 2
Variable Capacity Unit	SH1 > 7	AL = 0 or 1	no change	opening down		
		AL = 2		no change	opening up	no change
	SH1 ≤ 7	AL = 0 or 1	opening up	opening down	no change	opening down
		AL = 2		no change	opening up	no change

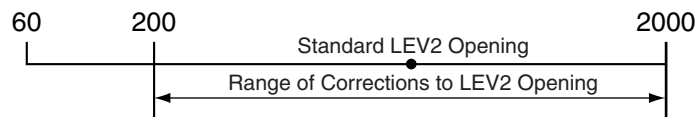

* Even when the constant capacity unit is stopped, the after-mentioned liquid refrigerant correction control operation may control LEV2 operations. After the power source has been turned on, and before the variable capacity unit compressor begins operation, the LEV2 is opened to 200. (After compressor operation begins, LEV2 = 60)

(11) Liquid Refrigerant Correction Control

The liquid refrigerant correction control adjusts the liquid refrigerant amounts between both accumulators in the unlikely event that the liquid refrigerant amount in both the constant and variable capacity unit accumulators should be insufficient, or if and excessive amount of liquid refrigerant is returned from either accumulator.

During this operation, Service LED No. 4 on the variable capacity unit will light up.

Direction of Accumulator Liquid Transfer	Start Conditions	Actuator Action						Stopping Conditions	LED Monitor No.4
		Constant Capacity Unit				Variable capacity unit	Indoor Unit		
		Com-pressor	LEV2	SV5b	Other				
Variable Capacity Unit Constant Capacity Unit ↓ Indoor Unit	<ul style="list-style-type: none"> In heating mode Run and stop indoor units are mixed. $Pd \geq 13k$ (1.27 MPa), or during an accumulator overflow preliminary error. $Td < 110^{\circ}C$ 	–	–	–	–	–	–	Operation: normal control Stop: LEV = 60 While all indoor units are operating $Td \geq 115^{\circ}C$	<ul style="list-style-type: none"> Verify surplus refrigerant LD1 lights up
Variable Capacity Unit ↓ Constant Capacity Unit	<ul style="list-style-type: none"> In heating mode While the constant capacity unit is stopped. During an accumulator overflow preliminary error in the variable capacity unit (AL1 = 2) $TdSH < 40 \text{ deg} *1$ 	OFF	2000	ON (open)	–	–	–	<ul style="list-style-type: none"> AL1 = 0 or 1 Continuing for 20 minutes 	Liquid refrigerant control ② LD3 lights up
Variable Capacity Unit ↓ Constant Capacity Unit	<ul style="list-style-type: none"> In heating mode During constant capacity unit operation When AL1 = 2 is detected in the variable capacity unit. $TdSH < 40 \text{ deg} *1$ 	OFF	2000	ON (open)	–	–	–	<ul style="list-style-type: none"> AL1 = 0 or 1 AL2 = 2 Continuing for 10 minutes 	Liquid refrigerant control ④ LD5 lights up
Variable Capacity Unit ↓ Constant Capacity Unit	<ul style="list-style-type: none"> In cooling mode While the constant capacity unit is stopped. During an accumulator overflow preliminary error in the variable capacity unit (AL1 = 2) Constant capacity unit AL2 = 0 or 1 Variable capacity unit $TH6 < 25^{\circ}C$ 	OFF	2000	ON (open)	Fan ON	Operation frequency level up	All indoor unit LEV = 60	<ul style="list-style-type: none"> AL1 = 0 or 1 Continuing for 15 minutes 	Liquid refrigerant control ⑥ LD7 lights up
Variable Capacity Unit ↓ Constant Capacity Unit	<ul style="list-style-type: none"> In heating mode Constant capacity unit switches from operation to stopping. Constant capacity unit AL2 = 0 	OFF	2000	ON (open)	–	–	–	<ul style="list-style-type: none"> AL1 = 0 or 1 Continuing for 3 ~ 6 minutes 	Liquid refrigerant control ⑦ LD8 lights up
Constant Capacity Unit ↓ Variable Capacity Unit	<ul style="list-style-type: none"> In heating mode During an accumulator overflow error delay in the constant capacity unit (AL2 = 2) Variable capacity unit AL1 = 0 or 1 	–	–	–	–	Operation frequency level down	–	<ul style="list-style-type: none"> AL2 = 0 or 1 AL1 = 2 Continuing for 10 minutes 	Liquid refrigerant control ③ LD4 lights up
Constant Capacity Unit ↓ Variable Capacity Unit	<ul style="list-style-type: none"> During cooling or heating During an accumulator overflow preliminary error in the constant capacity unit (AL2 = 2) Variable capacity unit AL1 = 0 or 1 	OFF	2000	ON (open)	LEV1 = 480 SV4 ON 21S4 OFF	21S4a, b ON	All indoor unit LEV = 60	<ul style="list-style-type: none"> AL1 = 2 Continuing for 4 minutes 	Liquid refrigerant control ⑤ LD6 lights up

* 1 TdSH (Discharge temperature superheating) = Discharge temperature (TH11 or TH12) - Tc (High pressure saturation temperature)

(12) Refrigerant recovery control

Refrigerant recovery is conducted to prevent refrigerant from accumulating in the stopped unit (fan unit), the unit under cooling mode and that with heating thermostat being turned off.

1) Start of refrigerant recovery

- ① Refrigerant recovery is started when the two items below are fully satisfied.
 - 30 minutes has passed after finishing refrigerant recovery.
 - The variable capacity unit level detector or the constant capacity unit level detector detects AL = 0 for 3 minutes continuously, or the discharge SH is high.

2) Refrigerant recovery operation

- Refrigerant is recovered by opening LEV of the objective indoor units (indoor units under stop. fan, and cooling modes, and that with heating thermostat being turned off) for 30 seconds.

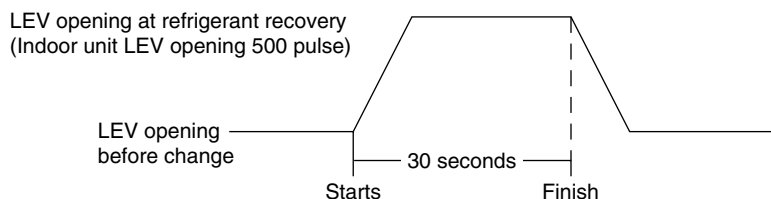

- The regular capacity control of the outdoor unit and the regular LEV control of the indoor unit are not applied during refrigerant recovery operation, but are fixed with the value before the recovery operation. These controls will be conducted one minute after finishing the recovery operation.
- Defrosting operation is prohibited during the recovery operation, and it will be conducted after finishing the recovery operation.

(13) Outdoor unit heat exchanger capacity control

Variable capacity unit

1) Control method

- In order to stabilize the evaporation temperature during cooling and the high-pressure pressure during heating that are required in response to performance needs, the capacity of the outdoor heat exchanger is controlled by regulating the fan volume of the outdoor unit by phase control and controlling the number of fans and by using the solenoid valves.

2) Control

- When both of the compressors are stopped, the fans for the outdoor units are also stopped.
- The fans operate at full speed for 10 seconds after starting.
- The fans for the outdoor unit are stopped during defrosting.

3) Capacity control pattern

Operating mode	Capacity control pattern	Heat exchanger capacity	No. of fans	Phase control	Notes
Cooling	①	50 %	1	10 to 100 %	21S4bON SV5bON
	②	100 %	2	10 to 100 %	21S4bOFF SV5bOFF
Heating	①	100 %	2	10 to 100 %	21S4bON SV5bOFF
Defrosting	①	100 %	0	0 %	21S4bOFF SV5bOFF

Note 1: When there is conductivity at SV5b, it is open. When there is no conductivity at SV5b, it is closed.

Note 2: When the unit is stopped, and SV5b are open.

Note 3: When the unit is stopped, there is no conductivity at 21S4b, in cooling mode and SV5b is opened.

Constant capacity unit

1) Control Method

- In response to performance needs, the fan level is controlled by the same phase control used in the variable capacity unit.

2) Control

- The fan is stopped when the (constant capacity unit) compressor is stopped.
- The fan is operated at full speed for 5 seconds after the (constant capacity unit) compressor is started.
- The fan for the outdoor unit is stopped during defrosting.
- The fan is sometimes operated when the TH10a drops, even when the compressor is stopped.
- The fan is operated for several minutes after the compressor is stopped.

(14) Control at initial starting

- When the ambient temperature is low (5°C or less in cooling and – 5°C or less in heating), initial starting will not be performed even if the unit is started within 4 hours of the power being turned on.
- The following initial start mode will be performed when the unit is started for the first time after the power has been turned on.
- When operation volume is low in the indoor unit, the constant capacity unit may not run for as long as 7 hours. In order to finish initial operation mode quickly, increase the operation volume of the indoor unit and run under high-external temperature conditions.

<Flow chart of initial start mode>

- No.1 compressor: variable capacity unit No.1 compressor
- No.2 compressor: variable capacity unit No.2 compressor
- No.3 compressor: constant capacity unit compressor

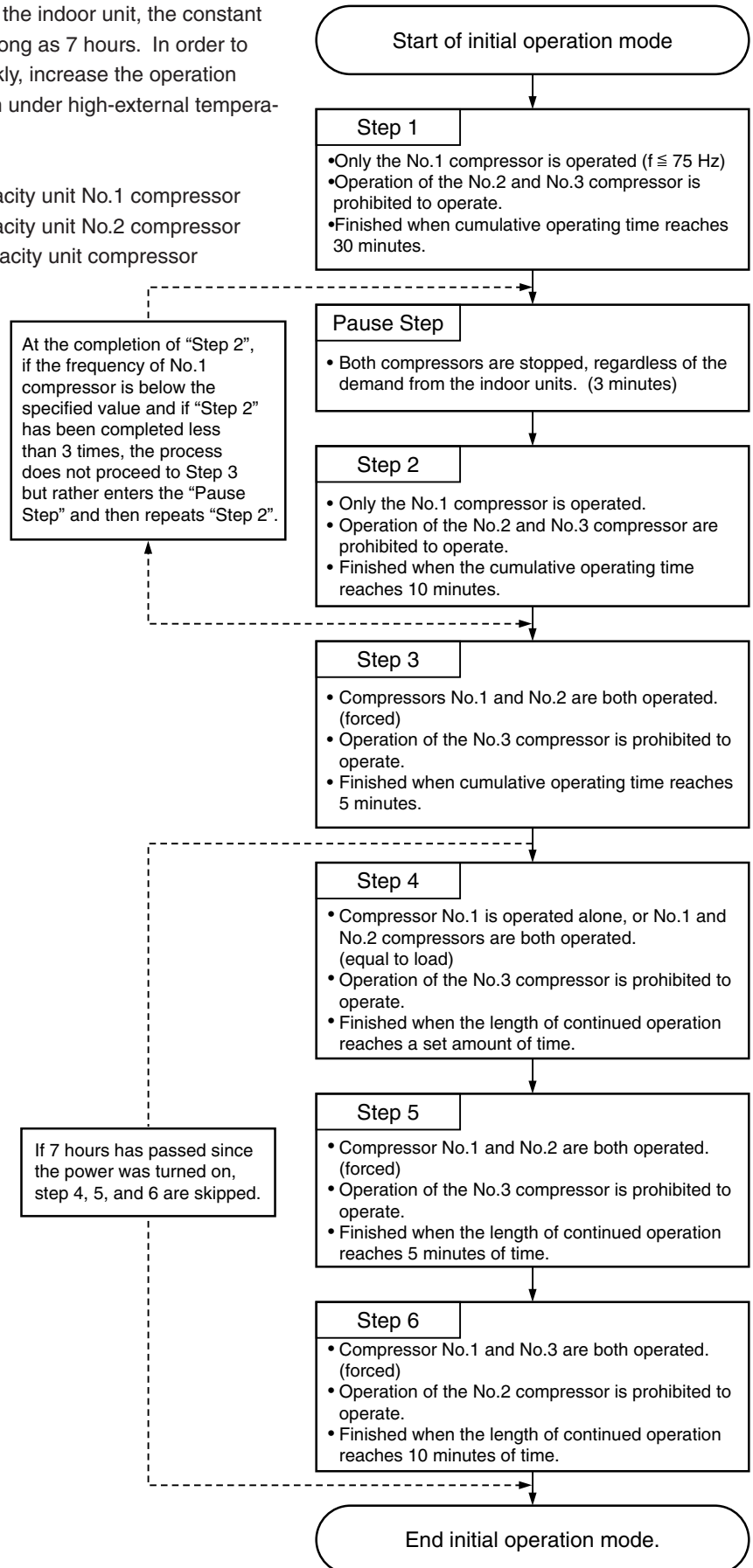

<Initial Start Control Timingchart>

For steps 1 - 3

(Example 1)

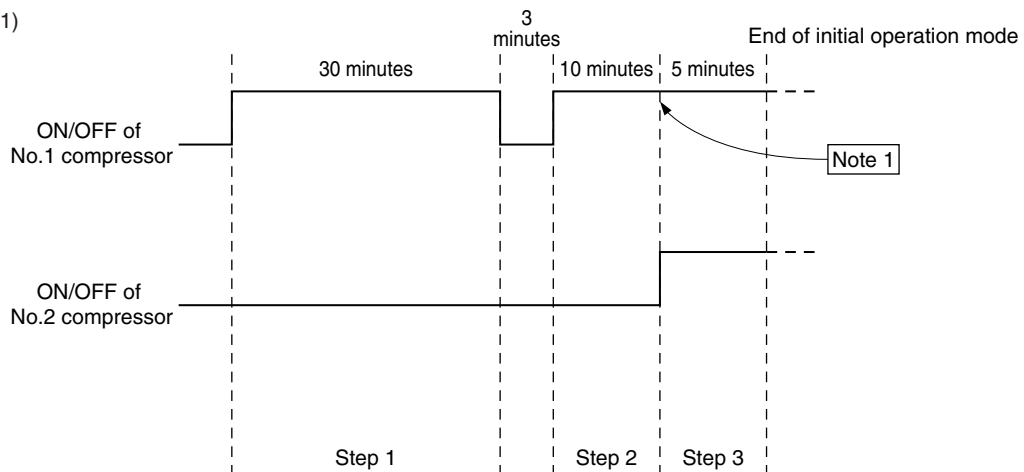

(Example 2)

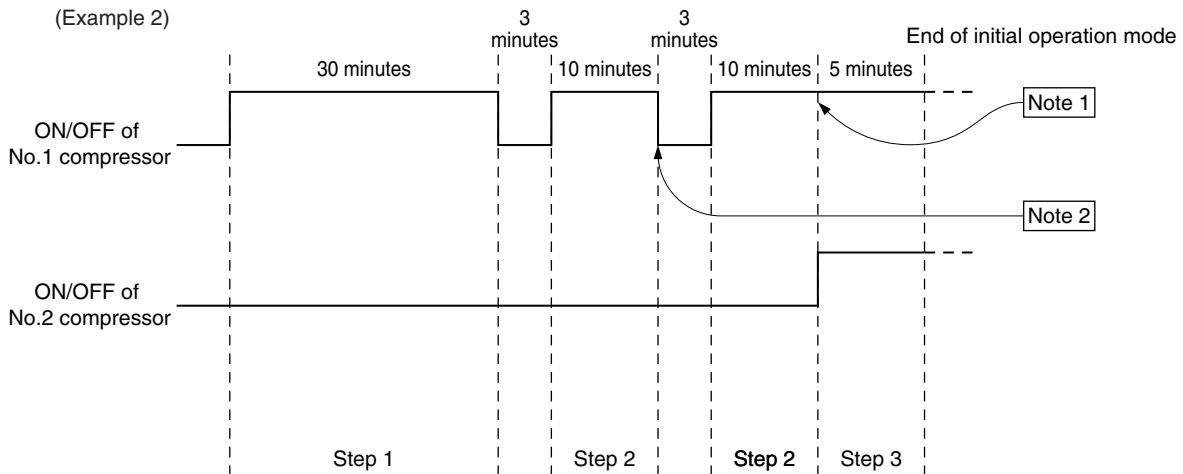

(Example 3)

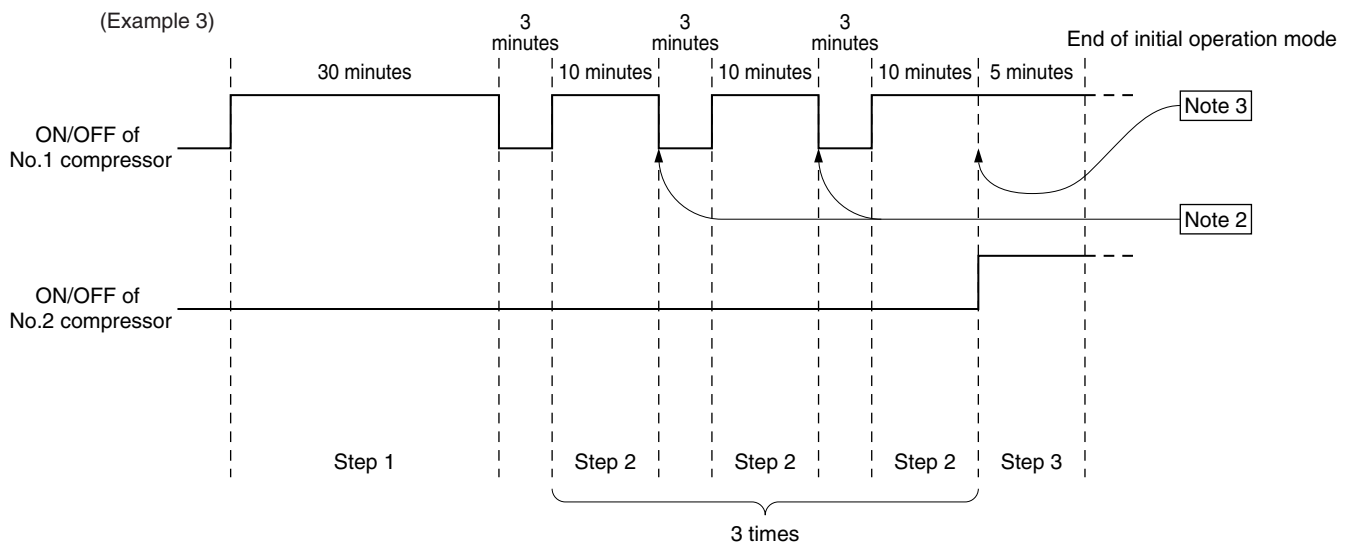

Note 1: If the frequency of No. 1 compressor is above the specified level at the end of Step 2, the mode proceeds to Step 3.

Note 2: At the completion of Step 2, if the frequency of No. 1 compressor is below the specified value and if Step 2 has been completed less than 3 times, the process does not proceed to Step 3 but rather enters the Pause Step and then repeats Step 2.

Note 3: At the completion of Step 2, if it has been completed more than 3 times, the mode will proceed to Step 3 even if the frequency of No. 1 compressor is below the specified value.

For steps 4 - 6
(Example 1)

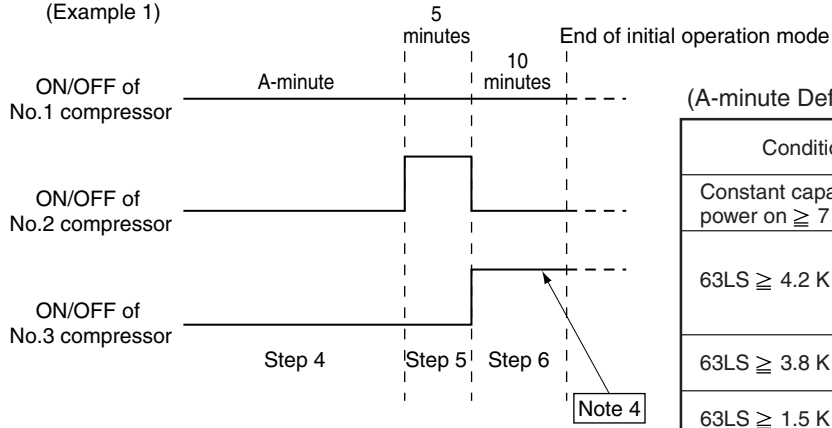

(A-minute Definitions)

Conditions	Operation Frequency Level (Hz)	A
Constant capacity unit power on ≥ 7 hours.	-	0 minute
$63LS \geq 4.2$ K	217 (For variable capacity unit model 500) 183 (For variable capacity unit model 400)	10 minutes
$63LS \geq 3.8$ K	100	25 minutes
$63LS \geq 1.5$ K	100	50 minutes
Other	Less than 100	7 hr

(Example 2)

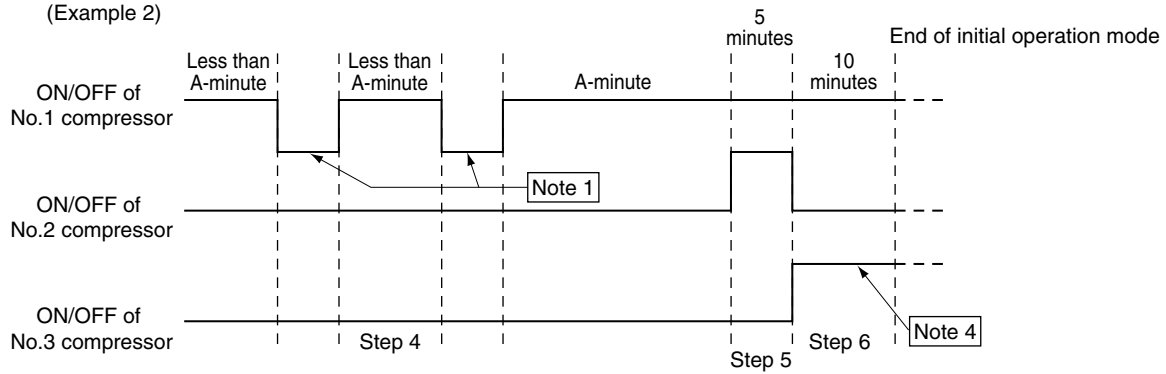

(Example 3)

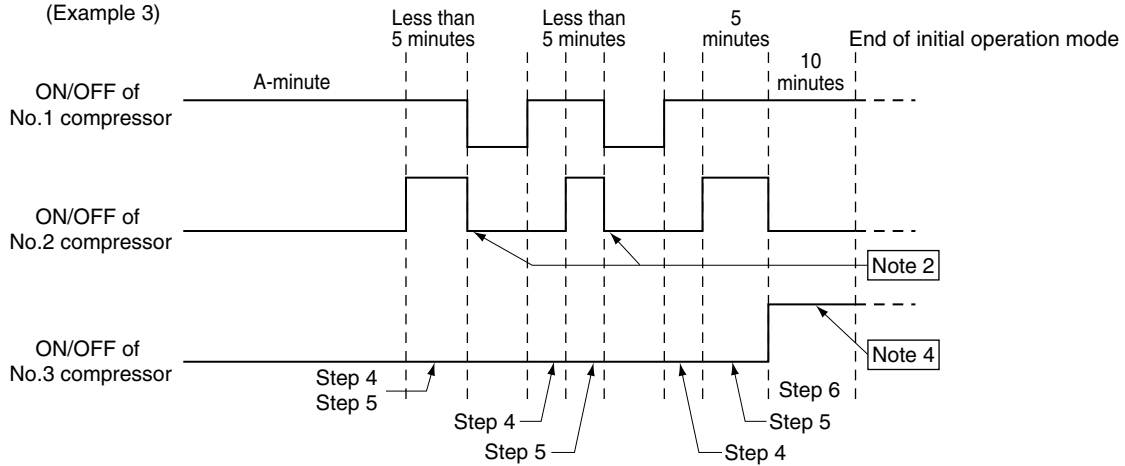

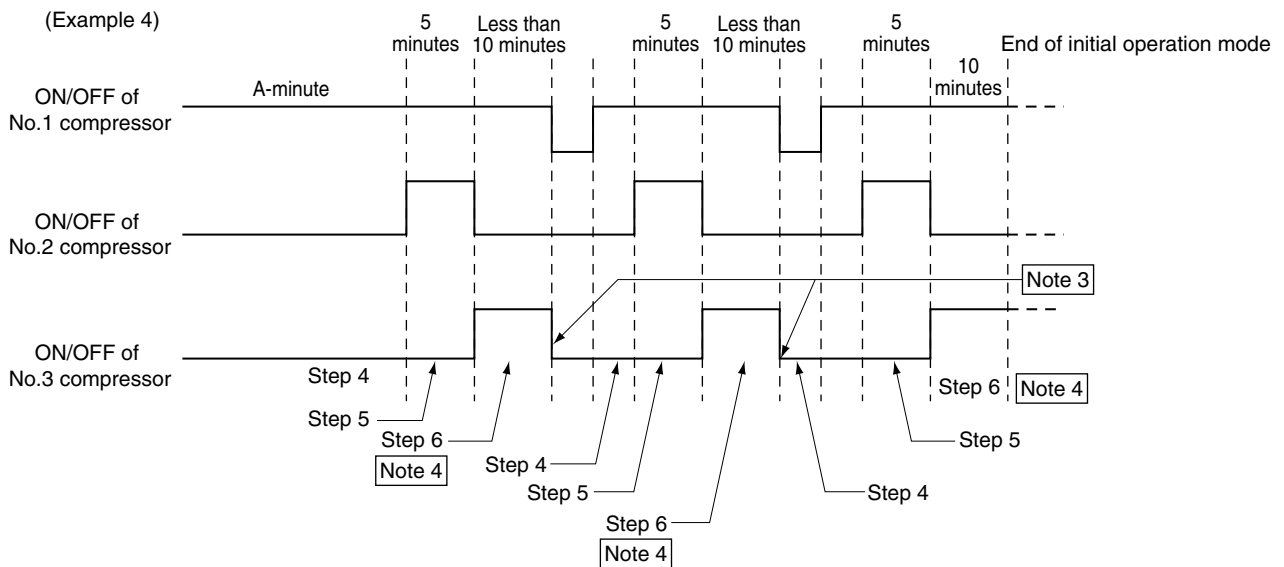

Note 1: If Step 4 is interrupted (compressor stopped by thermostat OFF or regular stop), Step 4 will be redone at restart.

Note 2: If Step 5 is interrupted, Step 5 will be redone at restart after performing Step 4 several times.

Note 3: If Step 6 is interrupted, Step 5 and Step 6 will be redone at restart after performing Step 4 several times.

Note 4: During Step 6, the No. 3 compressor runs with Un-load operation.

(15) Operation Mode

1) Operating modes of the indoor unit

The following five modes can be set by the remote control.

①	Cooling mode
②	Heating mode
③	Dry mode
④	Fan mode
⑤	Stop mode

2) Operating modes of the outdoor unit

The following are the 3 modes for the outdoor unit.

①	Cooling mode	All indoor units are operated in cooling mode
②	Heating mode	All indoor units are operated in heating mode
③	Stop mode	All indoor units are in fan or stop mode

Note: If the outdoor unit has been in the cooling mode and the other indoor units (in stop, fan, thermostat off) are set to the heating mode, those indoor units will not be operated and the heating indicator will be flashed on the remote controller. The reverse also applies when the outdoor unit is operated in the heating mode and the cooling indicator will be flashed on the remote controller.

(17) Emergency response operating mode

The emergency operation mode is a mode in which the unit is run in an emergency to respond to the trouble when the compressors (No. 1, No. 2) break down, making it possible to carry out a trouble reset using the remote control.

1) Starting the Emergency Operation Mode

- ① Trouble occurs (Display the trouble code root and trouble code on the remote control).
- ② Carry out trouble reset with the remote control.
- ③ If the trouble indicated in ① above is of the kind that permits emergency operation (see the table below), initiate a retry operation.

If the trouble indicated in ① above is of the kind where emergency operation is impossible (see the table below), restart operation after carrying out the previous trouble reset (without entering the emergency operation mode).

- ④ If the same trouble is detected again during the retry operation in ③ above, carry out trouble reset once more with the remote control, then try emergency operation starting corresponding to the contents of the trouble.

Table Emergency Operation Mode Patterns and Trouble Codes for which Emergency Operation is Possible or Impossible

Emergency Mode Pattern	Codes for which emergency operation is possible.	Trouble Codes for which Emergency Operation is Impossible	Action
When a No. 1 Compressor Failure Occurs	Serial transmission trouble 0403 VDC sensor/circuit trouble 4200 Breaking of overcurrent 4210 Bus voltage trouble 4220 Radiator panel overheat protection 4230 Overcurrent protection 4240 Cooling fan trouble 4260 Thermal sensor trouble (Radiator panel) 5110 IDC sensor/circuit trouble 5301	Trouble codes other than those at left.	Emergency Operation with the No. 2 and No. 3 Compressor * After the retry operation, even if there is a different trouble code detected within <Inverter Trouble> at left, press the button and after resetting, start the unit by emergency operation. [Example] 4250 → Reset → Retry → 4240 → Reset → Emergency operation
When No. 2 Compressor Failure Occurs	Overcurrent protection		Emergency Operation with the No. 1 and No. 3 Compressor
Constant capacity unit Error (stop)	Error codes other than those at right.	(a) High pressure/ low-pressure pressure error 1302 (b) Reverse phase error 4103 (c) Communication error No communication with variable capacity unit (d) Constant capacity unit power-off and LEV2 open (e) Oil equalization circuit irregularity 1559	Emergency response operation with the variable capacity unit only (No. 1 and No. 2 compressor).

Caution

During emergency operation, only × marked percentage of indoor units can be operated during emergency operation. In case, more than × marked percentage of indoor units are operated, over than the percentage of indoor units would be on the stand-by mode.

Failed Compressor	External temp. (TH6)	Model 600 ~ 750	Notes
No.1	TH6 ≥ 20°C (cooling) or heating	× ≤ 60 ~ 70 %	No.2 + No.3 Compressors on
	TH6 < 20°C (cooling)	× ≤ 45 ~ 55 %	No.2 Compressor only
No.2	TH6 ≥ 20°C (cooling) or heating	× ≤ 65 ~ 75 %	No.1 + No.3 Compressors on
	TH6 < 20°C (cooling)	× ≤ 45 ~ 55 %	No.1 Compressor only
No. 3	Don't care	× ≤ 80 ~ 90 %	No.1 + No.2 Compressors on

2) Terminating Emergency Response Operation Mode

(Termination Conditions)

When one of the following conditions is met, emergency operation mode is terminated.

- ① Cumulative compressor operation time in the cooling mode exceeds 4 hours.
- ② Cumulative compressor operation time in the heating mode exceeds 2 hours.
- ③ Emergency operation mode trouble detected.

(Control During and After Termination)

- During and after termination, the compressor will be stopped and a repeat error code will be flashed on the remote controller.
- If there is a repeat trouble reset during termination, retry operations will start by repeating steps ① to ④ in 1).

[1]-4 PUHY-600-650-700-750 YSMF-B

(1) Initial processing

- When turning on power source, initial processing of microcomputer is given top priority.
- During initial processing, control processing corresponding to operation signal is suspended. The control processing is resumed after initial processing is completed. (Initial processing: Data processing in microcomputer and initial setting of each LEV opening, requiring approx. 2 minutes at the maximum.)

(2) Control at starting

- At startup, variable capacity unit operations will start first.
- For 3 minutes after starting, 60 Hz is the upper frequency limit. (When only No. 1 compressor is operating.)
- 75 Hz is the upper limit for the 30 minutes after the compressor has started operation.
- Normal control is performed after the initial start mode (described later) has been completed.

(3) Compressor capacity control

- Compressor is performed by the variable capacity compressor on the variable capacity unit (No. 1: inverter motor) and constant capacity compressor (No. 2: Model 500 has capacity control switching, Model 400 does not).
- In response to the required performance, the number of compressors operating, the switching of capacity control and the frequency of the variable capacitor compressor is controlled so that the evaporation temperature is between 0 and 5°C in cooling mode and that the high pressure is between 18 and 20 kg/cm²G (1.76 and 1.96 MPa) in heating mode.
- The fluctuation of the frequency of the variable capacitor compressor is as follows. It is performed at 3 Hz per second.

20 to 100 Hz (TH6 > 20°C in cooling mode, or in heating mode)

30 to 100 Hz (TH6 < 20°C in cooling mode)

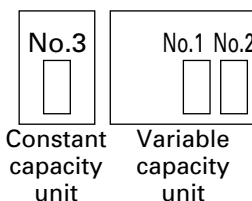

1) No. 2 compressor operation, stopping and full-load/un-load switching

① Switching from stop to run of No. 2 compressor.

When the required performance cannot be obtained by only No. 1 compressor, the No. 2 compressor will be started. (On Model 500, the No. 2 compressor will be started in un-load operation.)

- Model 400: After the No. 1 compressor has reached 98 Hz, the No. 2 compressor stops → starts.
- Model 500: After the No. 1 compressor has reached 100 Hz, the No. 2 compressor stops → un-load or un-load → full-load.

② Switching from run to stopping of No. 2 compressor.

When the required performance is exceeded when the two compressors, No. 1 and No. 2, are operating, the No. 2 compressor is stopped. (On Model 500, the No. 2 compressor will be performed in un-load operation.)

③ Switching from un-load to full-load of No. 2 compressor (Model 500 only)

When the required performance cannot be obtained by the No. 1 compressor and the No. 2 compressor operating in un-load, the No. 2 compressor will be switched to full-load operation.

④ Switching from full-load to un-load of No. 2 compressor (Model 500 only)

When the required performance is exceeded when the two compressors, No.1 and No. 2 operating in full-load, the No 2 compressor will be switched to un-load operation.

2) No. 3 compressor operation/stopping.

① Switching No. 3 compressor from stopping to operation

When the required performance cannot be obtained with only the No. 1 and No. 2 variable capacity unit compressors, the constant capacity unit No. 3 compressor will be started.

② Switching No. 3 compressor from operation to stopping

When the required performance is exceeded with the No. 1 and No. 2 variable capacity unit compressors and the constant capacity unit No. 3 compressor in operation, the No. 3 compressor will be stopped.

3) Pressure control

- The upper limit value for the high pressure (Pd) has been set for each frequency. When this value is exceeded, the frequency is reduced every 30 seconds.
- While the constant capacity unit is in operation, if the high pressure (63HS) value exceeds 25 kg/cm²G (2.45 MPa), the constant capacity unit compressor will be stopped.

4) Discharge temperature control

① The discharge temperature of the compressor (Variable capacity unit: TH11, TH12, Constant capacity unit: TH11) is monitored during the operation. If the upper limit is exceeded, the frequency is reduced by 5 Hz.

- Control is performed every 30 seconds after 30 seconds at the compressor starting.
- The operating temperature is 124°C.

② While the constant capacity unit is in operation, if the constant capacity unit discharge temperature (TH11) exceeds 130°C, the constant capacity unit compressor will be stopped.

5) Compressor frequency control

① Ordinary control

The ordinary control is performed after the following times have passed.

- 30 seconds after the start of the compressor or 30 seconds after the completion of defrosting.
- 30 seconds after frequency control operation by the discharge temperature or the high pressure.

② Amount of frequency fluctuation

The amount of frequency fluctuation is controlled in response to the evaporation temperature (TH2) and the high pressure (Pd) so that it will be approached the target values.

③ Frequency control back-up by the bypass valve

Frequency control is backed-up by the turning on (opening) the bypass valve (SV4) when only the No. 1 compressor is operated at its lowest frequency.

• Cooling

After the compressor has been operated for 15 minutes and only the No. 1 compressor is operated in un-load (its lowest frequency), the bypass valve is turned ON when the evaporation temperature (TH2) is – 30°C or less and turned OFF when it is – 15°C or more.

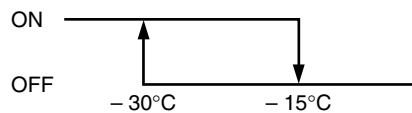

• Heating

After the compressor has been operated for 3 minutes and only the No. 1 compressor is operated in un-load (its lowest frequency), the bypass valve is turned ON when the high pressure (Pd) exceeds 25 kg/cm² (2.45 MPa) and turned OFF when it is 20 kg/cm² (1.96 MPa) or less.

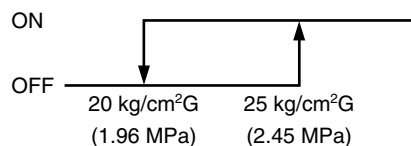

(4) Bypass - capacity control

The solenoid valves have bypass valves (SV1, SV4 and SV6) that allow bypassing of the high pressure and low pressure sides and solenoid valves (SV22 and SV32) that control the capacity valve inside the compressor. Those operation are as follows.

○ : Installed × : Not Installed

	SV1	SV4	SV6	SV22, SV32
Variable Capacity Unit	○	○	○	○
Constant Capacity Unit	○	○	×	×
Use	Maintenance of high-pressure/low-pressure, discharge temperature			Controls the compressors' internal volume control valve.

1) Bypass Valve (SV6) (SV6 is open when ON, variable capacity unit only)

- The valve is set as follows according to whether the variable capacity unit No. 1 and No. 2 compressors are operating.

No. 1 Compressor	No. 2 Compressor	SV6
Stopped	Stopped	OFF
Operating	Stopped	ON
Operating	Operating	OFF

2) Bypass solenoid valves (SV1, SV4) [Both SV1 and SV4 are on (open)]
 <Variable capacity unit>

Item	SV1		SV4	
	ON	OFF	ON	OFF
At compressor is started	ON for 4 minutes		—	
Compressor stopped during cooling or heating mode	ON		—	
After operation has been stopped	ON for 3 minutes		—	
During defrosting ((*1) in Fig below)	ON		Normally ON	
During oil recovery operation	ON during oil recovery operation after continuous low-frequency compressor operation.		—	
When low pressure saturation temperature (TH2) has dropped during lower limit frequency operation(15 minutes after start)	—		TH2 < - 30°C	TH2 ≥ - 15°C
When the high pressure (Pd) is risen up during lower limit frequency operation (3 minutes after starting)	Pd ≥ 27.5 kg/cm ² G (2.70 MPa)	Pd ≤ 24 kg/cm ² G (2.35 MPa) and after 30 seconds.	Pd ≥ 23 kg/cm ² G (2.26 MPa)	Pd ≤ 23 kg/cm ² G (2.26 MPa) and after 30 seconds
	—		ON when the high pressure (Pd) exceeds the control pressure limit.	Pd ≤ 20 kg/cm ² G (1.96 MPa)
When the discharge temperature (Td) is risen up	—		<ul style="list-style-type: none"> • Td > 130°C and • Pd > 20 kg/cm²G (1.96 MPa) or TH2 < - 10°C	Td ≤ 115°C

* Example of operation of SV1

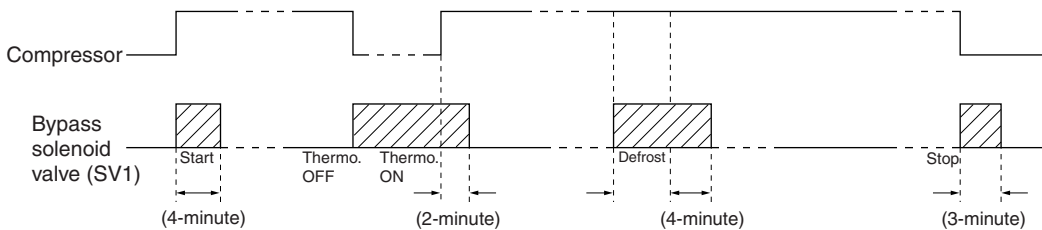

<Constant Capacity Unit>

Item	SV1		SV4	
	ON	OFF	ON	OFF
At compressor is started	ON for 4 minutes		—	
After thermostat reset or 3 minutes after startup	ON for 4 minutes		—	
Compressor stopped during cooling or heating mode	ON for 3 minutes		—	
After operation has been stopped	ON for 3 minutes		—	
During defrosting ((*1) in Fig below)	ON during normal operation		—	
When low pressure (63LS) has dropped	Low pressure (63LS) < 1.0 kg/cm ² G (0.098 MPa)	Low pressure (63LS) ≥ 1.5 kg/cm ² G (0.147 MPa)	—	—
When the high pressure (Pd) is risen up	Pd ≥ 26.5 kg/cm ² G (2.55 MPa)	Pd ≤ 23 kg/cm ² G (2.25 MPa) and after 30 seconds	—	—
When the discharge temperature (Td) is risen up.	When the discharge temperature > 130°C and high pressure (Pd) > 20 kg/cm ² G (1.96 MPa) or low pressure (63LS) < 2.5 kg/cm ² G (0.245 MPa).	When the discharge temperature ≤ 115°C	—	—
When the high pressure (Pd) is fallen up.	—		In heating mode, at starting and low volume of indoor unit, if high pressure (Pd) < 12 kg/cm ² G (1.18 MPa) and low pressure saturation temperature (ET) < -20°C	When the high pressure (Pd) ≥ 13 kg/cm ² G (1.27 MPa) and after 30 minutes of operation.

* Example of SV1 operation

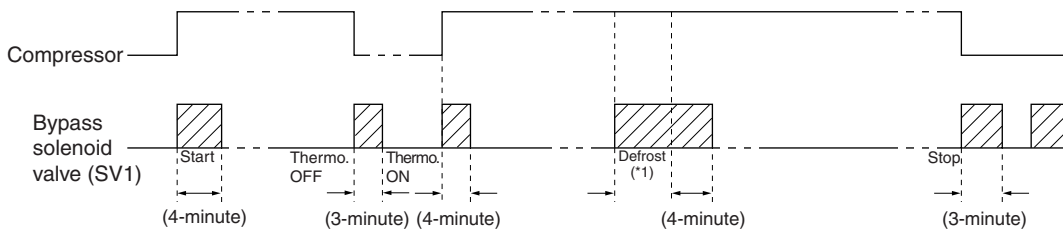

3) Capacity control solenoid valve (SV22, SV32) *Model 500 only.

• Operation of solenoid valve

Solenoid valve	SV22		SV32	
	Coil	Valve	Coil	Valve
Full-load (Operating at 100 % capacity)	OFF	Open	OFF	Closed
Un-load (Capacity control operation)	ON	Closed	ON	Open

- SV22 and SV32 stand for SV2 and SV3 of the No. 2 compressor.

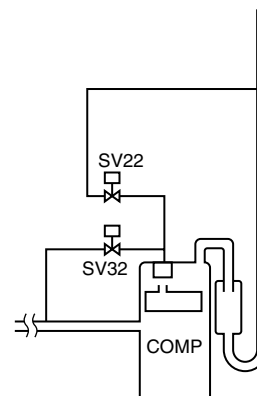

(5) Oil return control (Electronic expansion valve (SLEV); Variable Capacity Unit only)

- The amount of opening of the oil-return LEV (SLEV) is determined as follows: in cooling, by the operating capacity of the No. 1 compressor and the ambient temperature; in heating, by the operating capacity of the No. 1 compressor.
- It is opened (64) when both compressors are stopped and started for 10 minutes. (Upper limit of LEV opening is So = 388 pulse.)
- SLEV = 0 when the No. 1 compressor is stopped.

(6) Sub-cool coil control (Electronic expansion valve (LEV1))

- The sub-cool coil control provides control every 30 seconds to keep the super heat volume from the temperature of the inlet/outlet of the sub-cool coil (TH8, TH9) within a stable range (2 to 4 degrees).
- It controls by correcting the amount of opening according to the temperature of the inlet/outlet of the sub-cool coil (TH5, TH7), the high pressure (Pd) and discharge temperature.
- It is closed (0) in heating or when the compressor is stopped.
- It has a fixed opening (480) in defrosting.
- During normal control, the operating range is 46 to 480 (Variable capacity unit), 46 to 300 (Constant capacity unit).

(7) Defrosting control

Defrosting operation controls vary depending on the state of operations before defrosting begins.

		Defrost 1 - ①	Defrost 1 - ②	Defrost 2
State of operations before defrosting	Variable capacity unit	Operating	Operating	Operating
	Constant capacity unit	Operating	Stopped	Stopped
Defrosting operation control	Variable capacity unit	Defrost	Defrost	Defrost
	Constant capacity unit	Defrost	Defrost *1	Stopped *2
	Indoor unit LEV	Full open		Full closed

*1 When the cumulative operating time of the constant capacity unit compressor \geq 30 minutes.

*2 When the cumulative operating time of the constant capacity unit compressor < 30 minutes.

1) Start of defrosting

① Defrost 1 - ①, ②

- After there has been heating operation for 50 minutes and a piping temperature (TH5) of 0°C or less is detected for a preset time in either the variable or constant capacity units, defrosting starts.

② Defrost 2

- After there has been heating operation for 50 minutes, and a piping temperature of (TH5) of 0°C or less is detected for a preset time in the variable capacity unit, defrosting starts.

③ Forced Defrosting

- When 10 minutes has passed since the compressor began operation, or if 10 minutes has passed since recovery from defrosting, setting the forced defrosting switch (DIPSW2-7) to ON starts forced defrosting.

2) End of Defrosting

① Defrost 1 - ①, ②

- Defrosting ends when 15 minutes has passed since the start of defrosting or when the piping temperature (TH5) of both the variable and constant capacity units becomes 7°C or more.

② Defrost 2

- Defrosting ends when 15 minutes has passed since the start of defrosting or when the piping temperature (TH5) of the variable capacity unit becomes 8°C or more.

* Ending the defrosting is prohibited for 2 minutes after the start of defrosting. (Note that the defrosting operation will be stopped if the piping temperature exceeds 20°C or if the high pressure (Pd) exceeds 20 kg/cm²G (1.96 MPa).)

3) Defrost-prohibit

- Defrosting is not performed for 10 minutes after the start of compressor operation and during oil recovery mode.

4) Abnormalities during defrosting

- If an error is detected during defrosting, the defrosting is stopped and the defrost-prohibit time is set to 20 minutes by the compressor cumulative operating time.

- 5) Change in number of operating indoor units while defrosting
 - If the number of indoor units changes while the outdoor unit is defrosting, the defrosting operation continues. Once defrosting has ended, control for changing the number of units is performed.
 - If the indoor unit is stopped while the outdoor unit is defrosting or if the thermostat is set to off, the defrosting operation continues. Once defrosting has ended, the unit is stopped.
- 6) Number of compressors operating during defrosting
 - The number of compressors operating during defrosting is three in defrost 1 - ① or ②, two in defrost 2.

(8) Control of liquid level detecting heater

Detect refrigerant liquid level in accumulator, and heat refrigerant with liquid level heater for judging refrigerant amount. 7 steps of duty control is applied to liquid level heater depending on frequency and outdoor air temperature, 1minute after starting compressor.

(9) Judgement and control of refrigerant amount

- Judge refrigerant amount by detecting refrigerant liquid surface accumulator.

1) Judgement of accumulator liquid level

- Return refrigerant from accumulator liquid level detecting circuit to compressor inlet pipe, detect piping temperature, and judge liquid level.

When heated with heater, liquid refrigerant temperature is almost equal to low pressure saturation temperature, and gas refrigerant temperature is a little higher than low pressure saturation temperature. By comparing these temperature A in accumulator inlet portion, refrigerant liquid level can be judged.

Accumulator liquid level is judged in 3 steps as shown in the figure, from temperature A and liquid level detecting temperatures (TH3, TH4). After deciding refrigerant status (Liquid: TH3 and TH4 are TH2 + 5°C or less, Gas: TH3 and TH4 are TH2 + 5°C or more), judge liquid level by comparing TH3 and TH4.

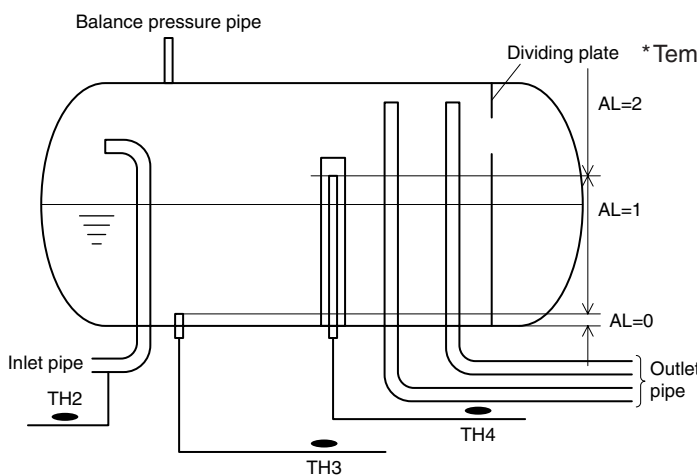

*Temperature A: low pressure saturation temperature.
 { Variable capacity unit; TH2
 { Constant capacity unit; Saturation temperature of 63LS

- Judgement by the AL is at best only a rough guideline. Please do not add refrigerant based on the AL reading alone.

2) Control of liquid level detection

① Prohibition of liquid level detection

Liquid level is detected in normal conditions except for the following;

(Cooling)

- For 6 minutes after starting unit, and during unit stopping.

(Heating)

- For 6 minutes after starting unit, and during unit stopping.

- During defrosting.

- For 10 minutes after refrigerant recovery.

(Note that liquid level determination is being performed even when liquid level detection is being disregarded.)

② In case AL = 2 is detected for 3 consecutive minutes during liquid level detection (control at excessive refrigerant replenishment and trouble mode)

- Changed to intermittent fault check mode preceded by 3 minutes restart prevention. But it is not abnormal when the discharge SH is high. Error stop is observed when trouble is detected again in the same intermittent fault check mode (for 30 minutes after unit stops for intermittent fault check).

- When turning on liquid level trouble ignore switch (SW2-4), error stop is not observed, and 3 minutes restart prevention by intermittent fault check mode is repeated. However, LED displays overflow.

(Turning SW2-4 on makes the error of TH6 < outdoor air sensor > ineffective.)

③ When operation mode shows "Stop," excessive or insufficient refrigerant display and excessive or insufficient refrigerant ignore display are extinguished.

(10) Liquid Distribution Control (electronic expansion valve (LEV2) constant capacity unit only)

- Liquid distribution control refers to the process by which liquid refrigerant returning from the constant and variable capacity units during heating is equally distributed, and the opening of the constant capacity unit LEV2 is adjusted so that there is no deficiency of liquid refrigerant in the accumulator of each unit.
- ① Distribution occurs during heating operations when both the variable and constant capacity units are in operation. When the constant capacity unit is stopped, the LEV2 opening = 60.
- ② The LEV2 opening is set to a standard which varies depending on the current operation frequency.
- ③ The levels of the superheating level (SH1) of the variable capacity unit TH2 and TH10 (whichever temperature is higher) and the accumulator liquid level (AL1) are compared to the superheating level (SH2) of the constant capacity unit TH9 and TH10a and the accumulator liquid level (AL2) to correct the standard opening of the LEV2 in ② above.

Chart: Corrections to the Standard LEV2 Opening

	Superheating Level		Constant Capacity Unit			
			SH2 > 3		SH2 ≤ 3	
	Accumulator Level	AL = 0 or 1	AL = 2	AL = 0 or 1	AL = 2	
Variable Capacity Unit	SH1 > 3	AL = 0 or 1	no change	opening down		
		AL = 2	opening up	no change	opening up	no change
	SH1 ≤ 3	AL = 0 or 1		opening down	no change	opening down
		AL = 2	no change	opening up	no change	

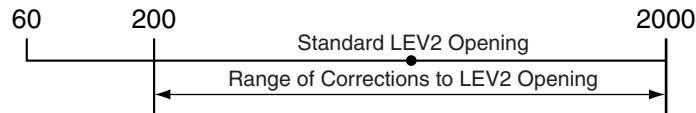

* Even when the constant capacity unit is stopped, the after-mentioned liquid refrigerant correction control operation may control LEV2 operations. After the power source has been turned on, and before the variable capacity unit compressor begins operation, the LEV2 is opened to 200. (After compressor operation begins, LEV2 = 60)

(11) Liquid Refrigerant Correction Control

The liquid refrigerant correction control adjusts the liquid refrigerant amounts between both accumulators in the unlikely event that the liquid refrigerant amount in both the constant and variable capacity unit accumulators should be insufficient, or if and excessive amount of liquid refrigerant is returned from either accumulator.

During this operation, Service LED No. 4 on the variable capacity unit will light up.

Direction of Accumulator Liquid Transfer	Start Conditions	Actuator Action						Stopping Conditions	LED Monitor No.4
		Constant Capacity Unit				Variable capacity unit	Indoor Unit		
		Com-pressor	LEV2	SV5b	Other				
Variable Capacity Unit Constant Capacity Unit ↓ Indoor Unit	<ul style="list-style-type: none"> In heating mode Run and stop indoor units are mixed. $Pd \geq 13k$ (1.27 MPa), or during an accumulator overflow preliminary error. $Td < 110^{\circ}C$ 	–	–	–	–	–	–	Operation: normal control Stop: LEV = 60 While all indoor units are operating $Td \geq 115^{\circ}C$	<ul style="list-style-type: none"> Verify surplus refrigerant LD1 lights up
Variable Capacity Unit ↓ Constant Capacity Unit	<ul style="list-style-type: none"> In heating mode While the constant capacity unit is stopped. During an accumulator overflow preliminary error in the variable capacity unit (AL1 = 2) $TdSH < 40 \text{ deg} *1$ 	OFF	2000	ON (open)	–	–	–	<ul style="list-style-type: none"> AL1 = 0 or 1 Continuing for 20 minutes 	Liquid refrigerant control ② LD3 lights up
Variable Capacity Unit ↓ Constant Capacity Unit	<ul style="list-style-type: none"> In heating mode During constant capacity unit operation When AL1 = 2 is detected in the variable capacity unit. $TdSH < 40 \text{ deg} *1$ 	OFF	2000	ON (open)	–	–	–	<ul style="list-style-type: none"> AL1 = 0 or 1 AL2 = 2 Continuing for 10 minutes 	Liquid refrigerant control ④ LD5 lights up
Variable Capacity Unit ↓ Constant Capacity Unit	<ul style="list-style-type: none"> In cooling mode While the constant capacity unit is stopped. During an accumulator overflow preliminary error in the variable capacity unit (AL1 = 2) Constant capacity unit AL2 = 0 or 1 Variable capacity unit $TH6 < 25^{\circ}C$ 	OFF	2000	ON (open)	Fan ON	Operation frequency level up	All indoor unit LEV = 60	<ul style="list-style-type: none"> AL1 = 0 or 1 Continuing for 15 minutes 	Liquid refrigerant control ⑥ LD7 lights up
Variable Capacity Unit ↓ Constant Capacity Unit	<ul style="list-style-type: none"> In heating mode Constant capacity unit switches from operation to stopping. Constant capacity unit AL2 = 0 	OFF	2000	ON (open)	–	–	–	<ul style="list-style-type: none"> AL1 = 0 or 1 Continuing for 3 ~ 6 minutes 	Liquid refrigerant control ⑦ LD8 lights up
Constant Capacity Unit ↓ Variable Capacity Unit	<ul style="list-style-type: none"> In heating mode During an accumulator overflow error delay in the constant capacity unit (AL2 = 2) Variable capacity unit AL1 = 0 or 1 	–	–	–	–	Operation frequency level down	–	<ul style="list-style-type: none"> AL2 = 0 or 1 AL1 = 2 Continuing for 10 minutes 	Liquid refrigerant control ③ LD4 lights up
Constant Capacity Unit ↓ Variable Capacity Unit	<ul style="list-style-type: none"> During cooling or heating During an accumulator overflow preliminary error in the constant capacity unit (AL2 = 2) Variable capacity unit AL1 = 0 or 1 	OFF	2000	ON (open)	LEV1 = 480 SV4 ON 21S4 OFF	21S4a, b ON	All indoor unit LEV = 60	<ul style="list-style-type: none"> AL1 = 2 Continuing for 4 minutes 	Liquid refrigerant control ⑤ LD6 lights up

* 1 TdSH (Discharge temperature superheating) = Discharge temperature (TH11 or TH12) - Tc (High pressure saturation temperature)

(12) Refrigerant recovery control

Refrigerant recovery is conducted to prevent refrigerant from accumulating in the stopped unit (fan unit), the unit under cooling mode and that with heating thermostat being turned off.

1) Start of refrigerant recovery

① Refrigerant recovery is started when the two items below are fully satisfied.

- 30 minutes has passed after finishing refrigerant recovery.
- The variable capacity unit level detector or the constant capacity unit level detector detects AL = 0 for 3 minutes continuously, or the discharge SH is high.

2) Refrigerant recovery operation

- Refrigerant is recovered by opening LEV of the objective indoor units (indoor units under stop. fan, and cooling modes, and that with heating thermostat being turned off) for 30 seconds.

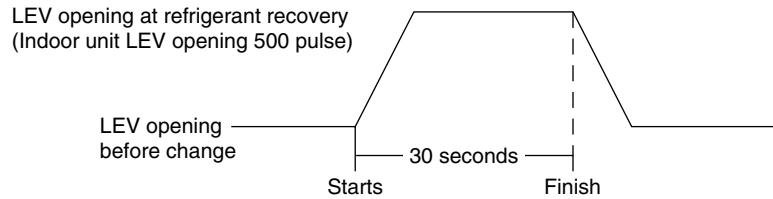

- The regular capacity control of the outdoor unit and the regular LEV control of the indoor unit are not applied during refrigerant recovery operation, but are fixed with the value before the recovery operation. These controls will be conducted one minute after finishing the recovery operation.
- Defrosting operation is prohibited during the recovery operation, and it will be conducted after finishing the recovery operation.

(13) Outdoor unit heat exchanger capacity control

Variable capacity unit

1) Control method

- In order to stabilize the evaporation temperature during cooling and the high-pressure pressure during heating that are required in response to performance needs, the capacity of the outdoor heat exchanger is controlled by regulating the fan volume of the outdoor unit by phase control and controlling the number of fans and by using the solenoid valves.

2) Control

- When both of the compressors are stopped, the fans for the outdoor units are also stopped.
- The fans operate at full speed for 10 seconds after starting.
- The fans for the outdoor unit are stopped during defrosting.

3) Capacity control pattern

Operating mode	Capacity control pattern	Heat exchanger capacity	No. of fans	Phase control	Notes
Cooling	①	50 %	1	10 to 100 %	21S4bON SV5bON
	②	100 %	2	10 to 100 %	21S4bOFF SV5bOFF
Heating	①	100 %	2	10 to 100 %	21S4bON SV5bOFF
Defrosting	①	100 %	0	0 %	21S4bOFF SV5bOFF

Note 1: When there is conductivity at SV5b, it is open. When there is no conductivity at SV5b, it is closed.

Note 2: When the unit is stopped, and SV5b are open.

Note 3: When the unit is stopped, there is no conductivity at 21S4b, in cooling mode and SV5b is opened.

Constant capacity unit

1) Control Method

- In response to performance needs, the fan level is controlled by the same phase control used in the variable capacity unit.

2) Control

- The fan is stopped when the (constant capacity unit) compressor is stopped.
- The fan is operated at full speed for 5 seconds after the (constant capacity unit) compressor is started.
- The fan for the outdoor unit is stopped during defrosting.
- The fan is sometimes operated when the TH10a drops, even when the compressor is stopped.
- The fan is operated for several minutes after the compressor is stopped.

(14) Control at initial starting

- When the ambient temperature is low (5°C or less in cooling and – 5°C or less in heating), initial starting will not be performed even if the unit is started within 4 hours of the power being turned on.
- The following initial start mode will be performed when the unit is started for the first time after the power has been turned on.
- When operation volume is low in the indoor unit, the constant capacity unit may not run for as long as 7 hours. In order to finish initial operation mode quickly, increase the operation volume of the indoor unit and run under high-external temperature conditions.

<Flow chart of initial start mode>

- No.1 compressor: variable capacity unit No.1 compressor
- No.2 compressor: variable capacity unit No.2 compressor
- No.3 compressor: constant capacity unit compressor

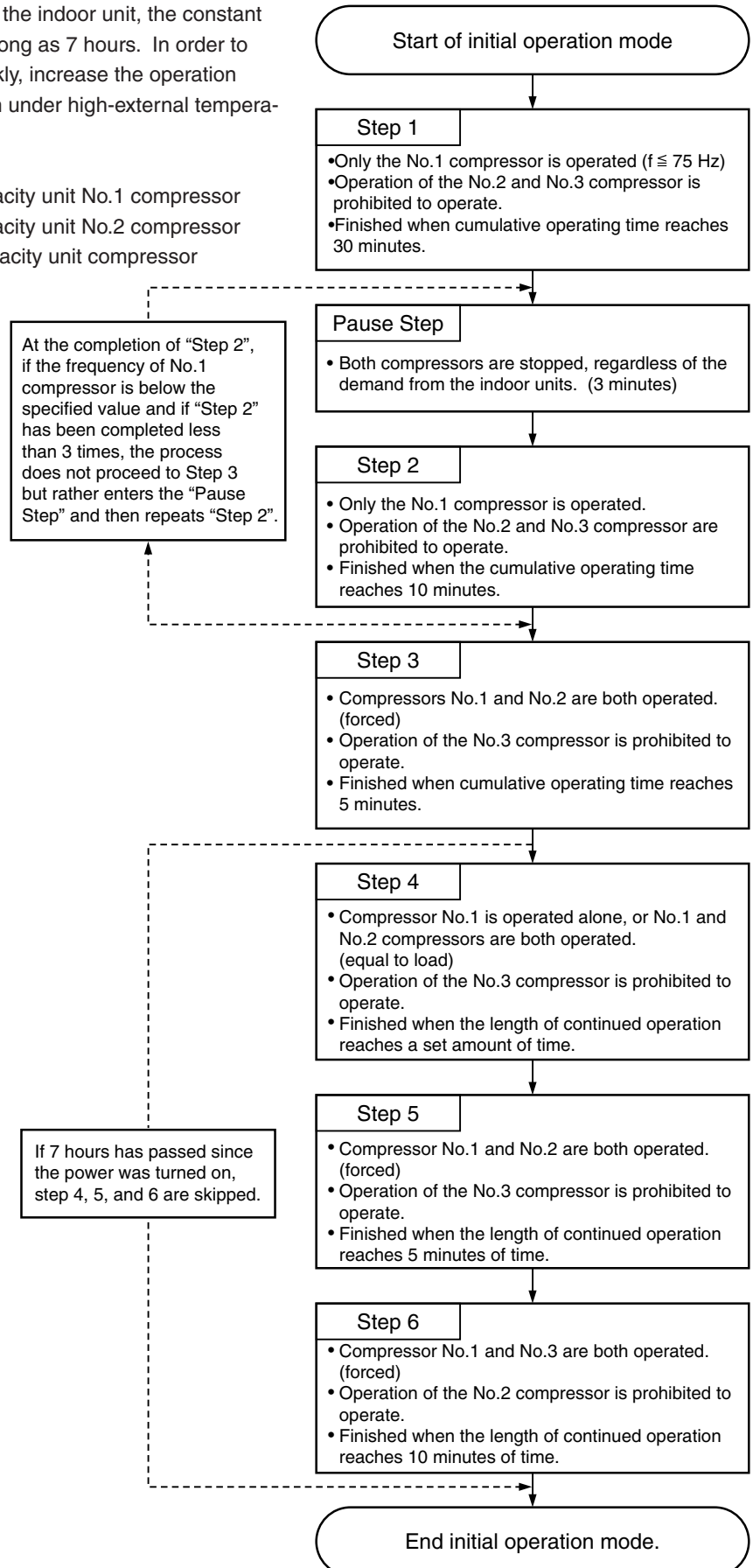

<Initial Start Control Timingchart>

For steps 1 - 3

(Example 1)

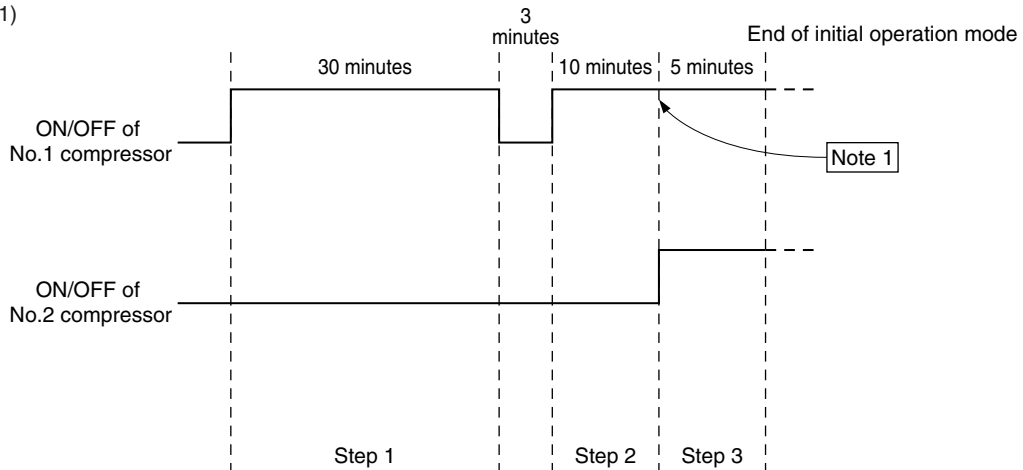

(Example 2)

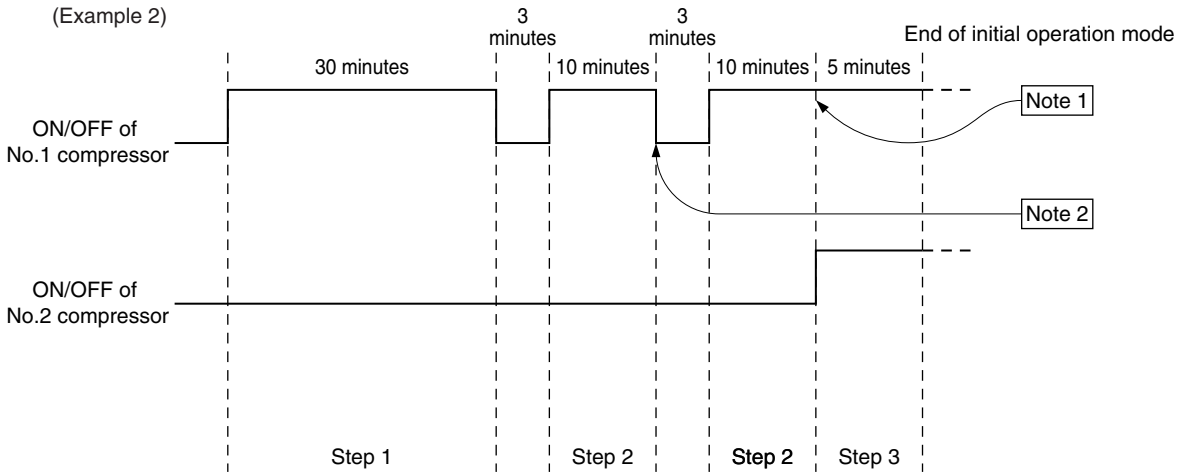

(Example 3)

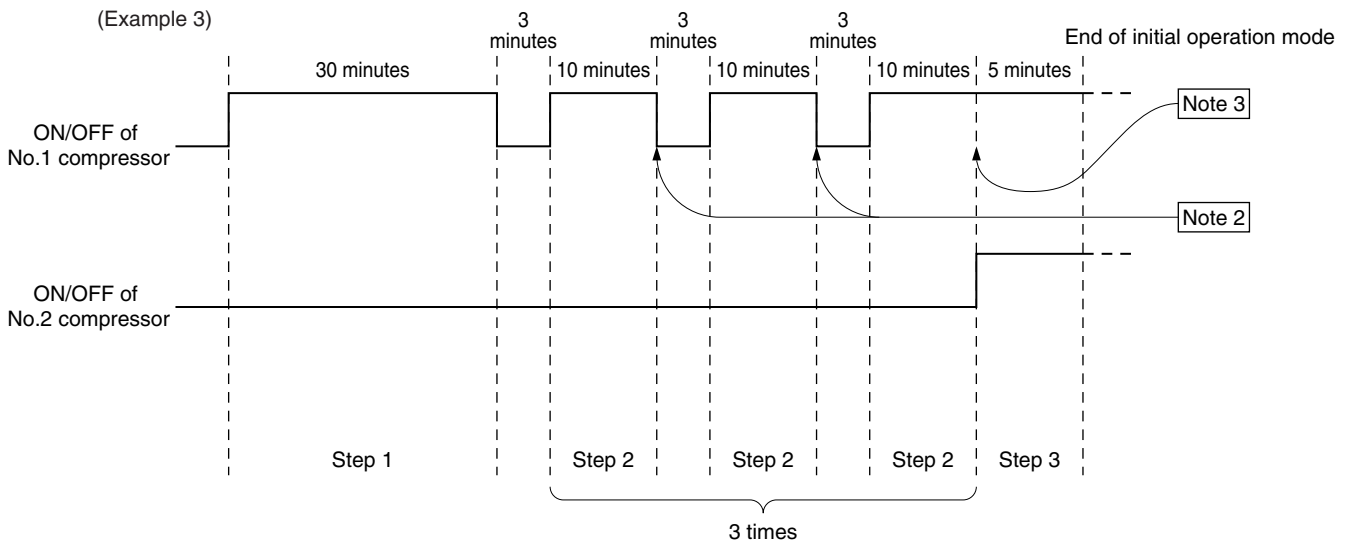

Note 1: If the frequency of No. 1 compressor is above the specified level at the end of Step 2, the mode proceeds to Step 3.

Note 2: At the completion of Step 2, if the frequency of No. 1 compressor is below the specified value and if Step 2 has been completed less than 3 times, the process does not proceed to Step 3 but rather enters the Pause Step and then repeats Step 2.

Note 3: At the completion of Step 2, if it has been completed more than 3 times, the mode will proceed to Step 3 even if the frequency of No. 1 compressor is below the specified value.

For steps 4 - 6

(Example 1)

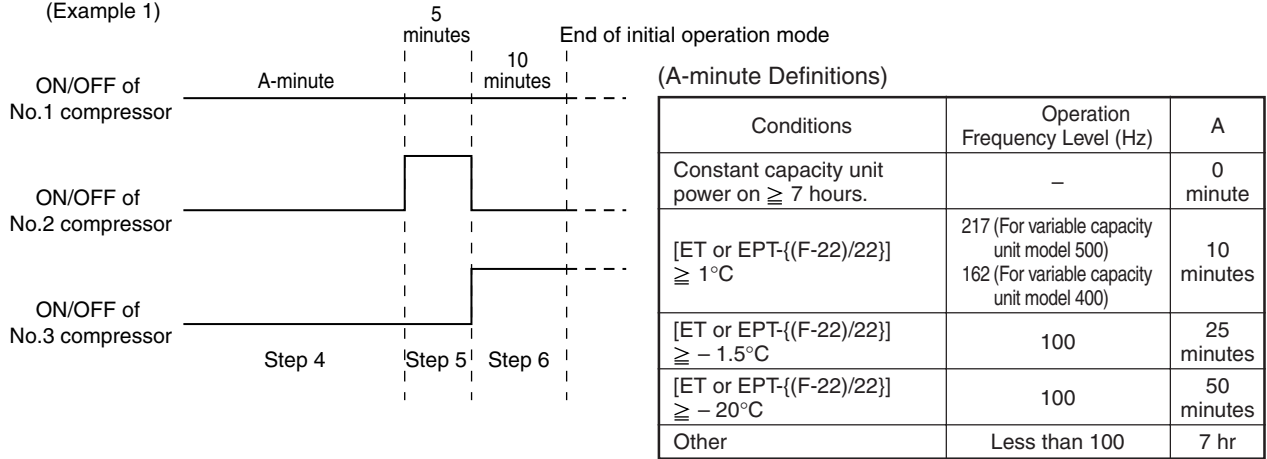

(Example 2)

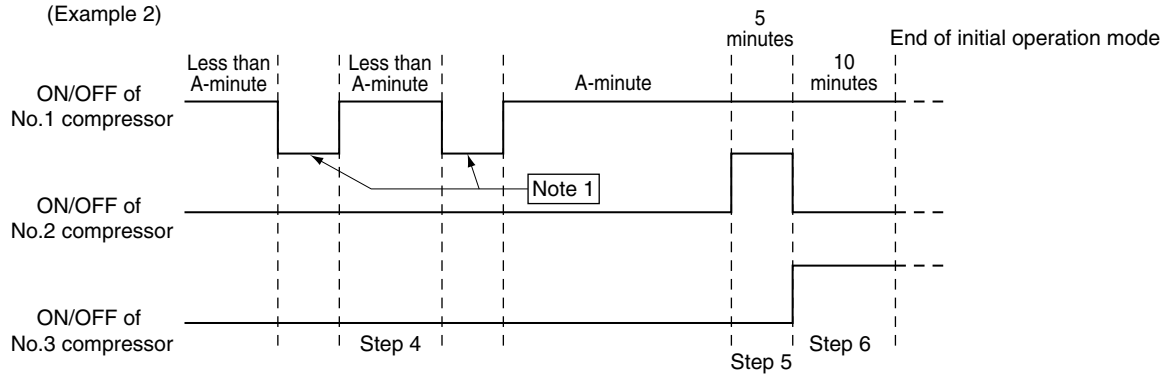

(Example 3)

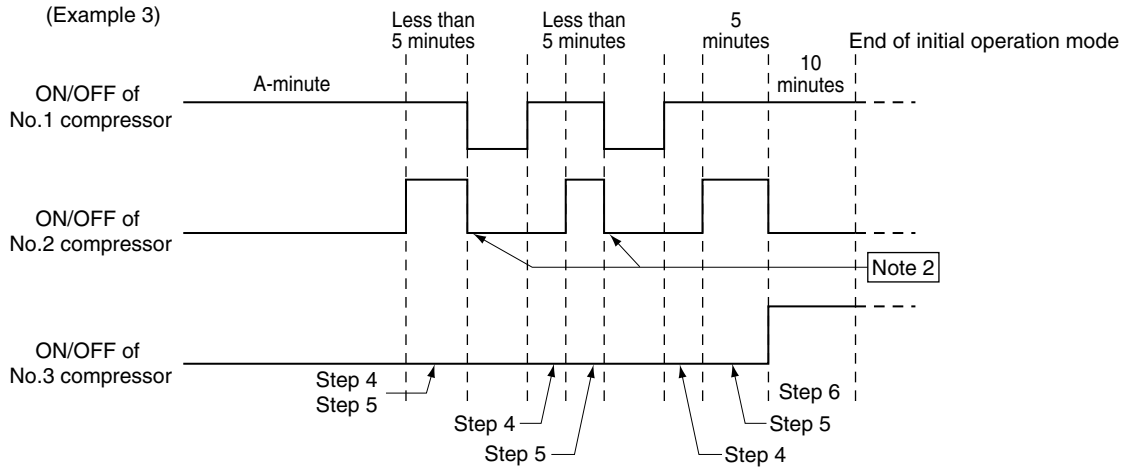

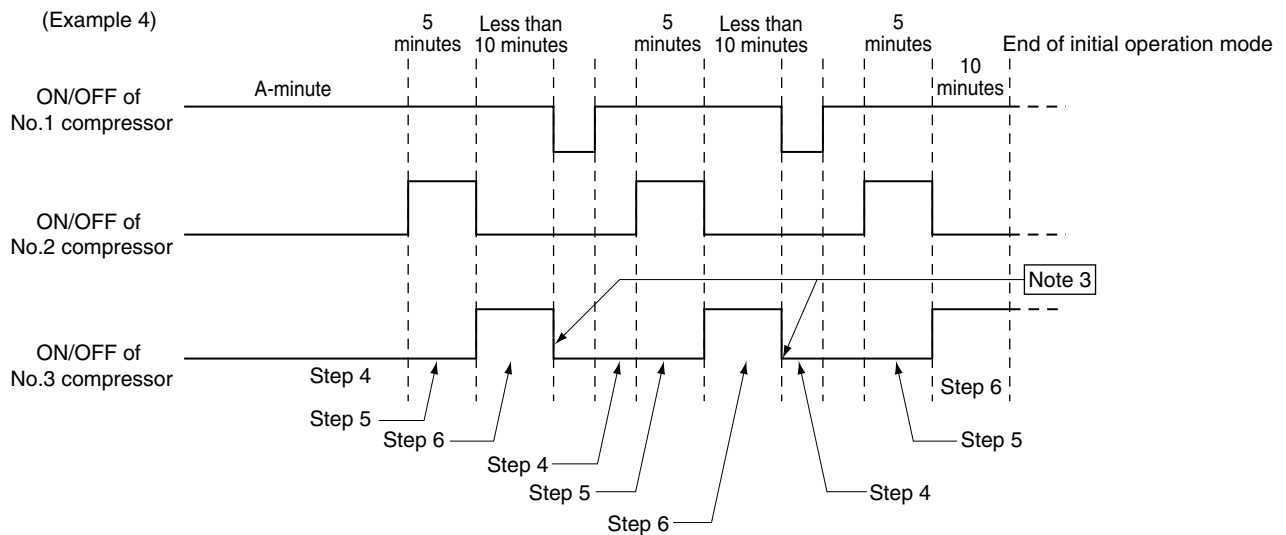

Note 1: If Step 4 is interrupted (compressor stopped by thermostat OFF or regular stop), Step 4 will be redone at restart.

Note 2: If Step 5 is interrupted, Step 5 will be redone at restart after performing Step 4 several times.

Note 3: If Step 6 is interrupted, Step 5 and Step 6 will be redone at restart after performing Step 4 several times.

(15) Operation Mode

1) Operating modes of the indoor unit

The following five modes can be set by the remote control.

①	Cooling mode
②	Heating mode
③	Dry mode
④	Fan mode
⑤	Stop mode

2) Operating modes of the outdoor unit

The following are the 3 modes for the outdoor unit.

①	Cooling mode	All indoor units are operated in cooling mode
②	Heating mode	All indoor units are operated in heating mode
③	Stop mode	All indoor units are in fan or stop mode

Note: If the outdoor unit has been in the cooling mode and the other indoor units (in stop, fan, thermostat off) are set to the heating mode, those indoor units will not be operated and the heating indicator will be flashed on the remote controller. The reverse also applies when the outdoor unit is operated in the heating mode and the cooling indicator will be flashed on the remote controller.

(17) Emergency response operating mode

The emergency operation mode is a mode in which the unit is run in an emergency to respond to the trouble when the compressors (No. 1, No. 2) break down, making it possible to carry out a trouble reset using the remote control.

1) Starting the Emergency Operation Mode

- ① Trouble occurs (Display the trouble code root and trouble code on the remote control).
- ② Carry out trouble reset with the remote control.
- ③ If the trouble indicated in ① above is of the kind that permits emergency operation (see the table below), initiate a retry operation.

If the trouble indicated in ① above is of the kind where emergency operation is impossible (see the table below), restart operation after carrying out the previous trouble reset (without entering the emergency operation mode).

- ④ If the same trouble is detected again during the retry operation in ③ above, carry out trouble reset once more with the remote control, then try emergency operation starting corresponding to the contents of the trouble.

Table Emergency Operation Mode Patterns and Trouble Codes for which Emergency Operation is Possible or Impossible

Emergency Mode Pattern	Codes for which emergency operation is possible.	Trouble Codes for which Emergency Operation is Impossible	Action
When a No. 1 Compressor Failure Occurs	Serial transmission trouble 0403 VDC sensor/circuit trouble 4200 Breaking of overcurrent 4210 Bus voltage trouble 4220 Radiator panel overheat protection 4230 Overcurrent protection 4240 Cooling fan trouble 4260 Thermal sensor trouble (Radiator panel) 5110 IDC sensor/circuit trouble 5301	Trouble codes other than those at left.	Emergency Operation with the No. 2 and No. 3 Compressor * After the retry operation, even if there is a different trouble code detected within <Inverter Trouble> at left, press the button and after resetting, start the unit by emergency operation. [Example] 4250 → Reset → Retry → 4240 → Reset → Emergency operation
When No. 2 Compressor Failure Occurs	Overcurrent protection		Emergency Operation with the No. 1 and No. 3 Compressor
Constant capacity unit Error (stop)	Error codes other than those at right.	(a)High pressure/ low-pressure pressure error 1302 (b)Reverse phase error 4103 (c)Communication error No communication with variable capacity unit (d)Constant capacity unit power-off and LEV2 open (e)Oil equalization circuit irregularity 1559	Emergency response operation with the variable capacity unit only (No. 1 and No. 2 compressor).

Caution

During emergency operation, only × marked percentage of indoor units can be operated during emergency operation. In case, more than × marked percentage of indoor units are operated, over than the percentage of indoor units would be on the stand-by mode.

Failed Compressor	External temp. (TH6)	Model 600 - 750	Notes
No.1	TH6 ≥ 20°C (cooling) or heating	× ≤ 60 ~ 70 %	No.2 + No.3 Compressors on
	TH6 < 20°C (cooling)	× ≤ 45 ~ 55 %	No.2 Compressor only
No.2	TH6 ≥ 20°C (cooling) or heating	× ≤ 65 ~ 75 %	No.1 + No.3 Compressors on
	TH6 < 20°C (cooling)	× ≤ 45 ~ 55 %	No.1 Compressor only
No. 3	Don't care	× ≤ 80 ~ 90 %	No.1 + No.2 Compressors on

2) Terminating Emergency Response Operation Mode

(Termination Conditions)

When one of the following conditions is met, emergency operation mode is terminated.

- ① Cumulative compressor operation time in the cooling mode exceeds 4 hours.
- ② Cumulative compressor operation time in the heating mode exceeds 2 hours.
- ③ Emergency operation mode trouble detected.

(Control During and After Termination)

- During and after termination, the compressor will be stopped and a repeat error code will be flashed on the remote controller.
- If there is a repeat trouble reset during termination, retry operations will start by repeating steps ① to ④ in 1).

[2] Operation Flow Chart

(1) Outdoor unit (Cooling, heating modes)

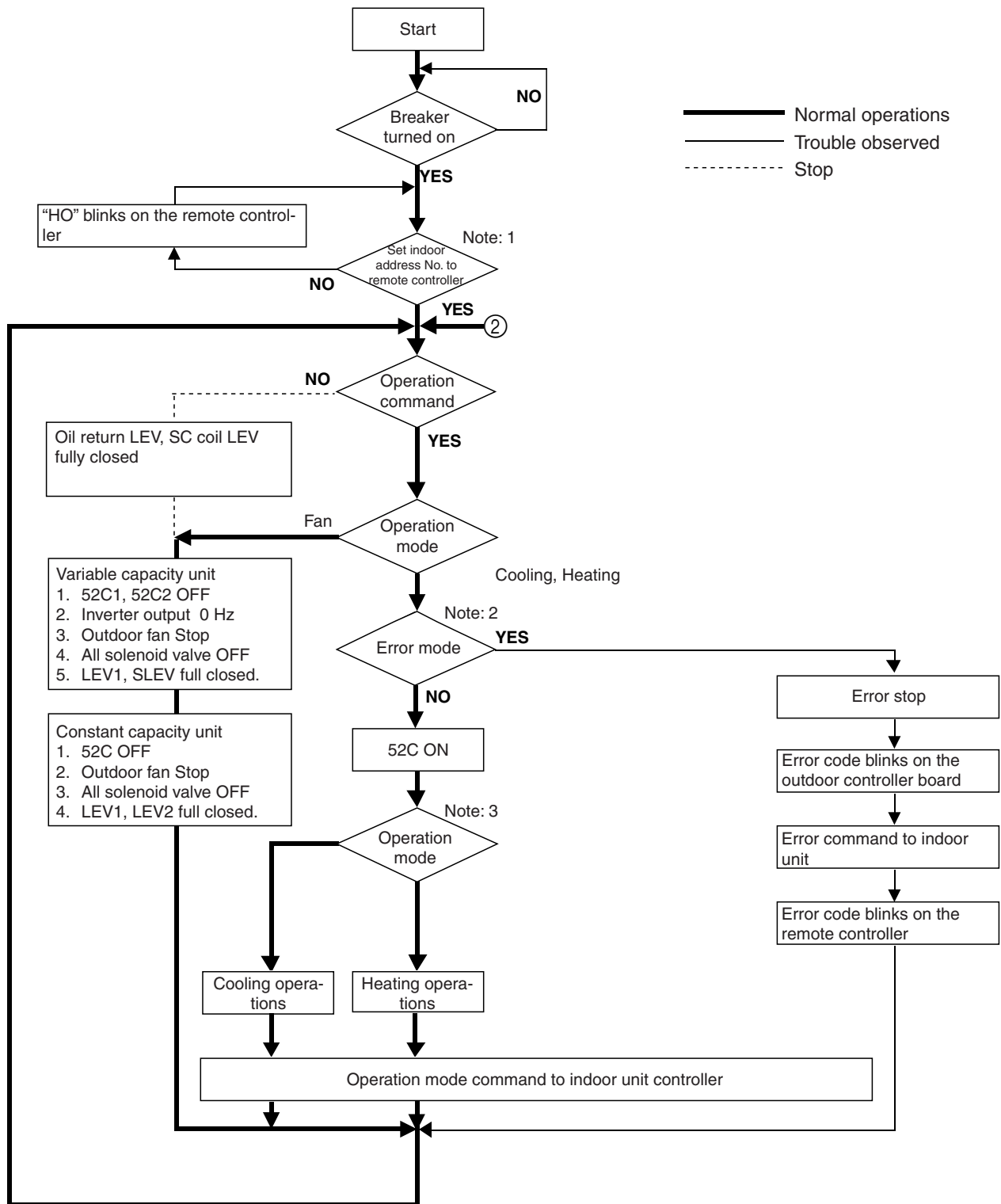

Note : 1	For about 2 minutes after turning on power source, address and group information of outdoor unit, indoor unit, and remote controller are retrieved by remote controller, during which "HO" blinks on and off on remote controller. In case indoor unit is not grouped to remote controller, "HO" display on remote controller continues blinking even after 2 minutes after turning on power source.
Note : 2	Two trouble modes included indoor unit side trouble, and outdoor unit side trouble. In the case of indoor unit side trouble, error stop is observed in outdoor unit only when all the indoor units are in trouble. However, if one or more indoor units are operating normally, outdoor unit shows only LED display without undergoing stop.
Note : 3	Operation mode conforms to mode command by indoor unit. However, when outdoor unit is being under cooling operation, the operation of indoor unit will be prohibited even by setting a part of indoor units under operation, or indoor unit under stopping or fan mode to heating mode. Reversely when outdoor unit is being heating operation, the same condition will be commenced.

(2) Indoor unit (Cooling, heating, dry, and fan modes)

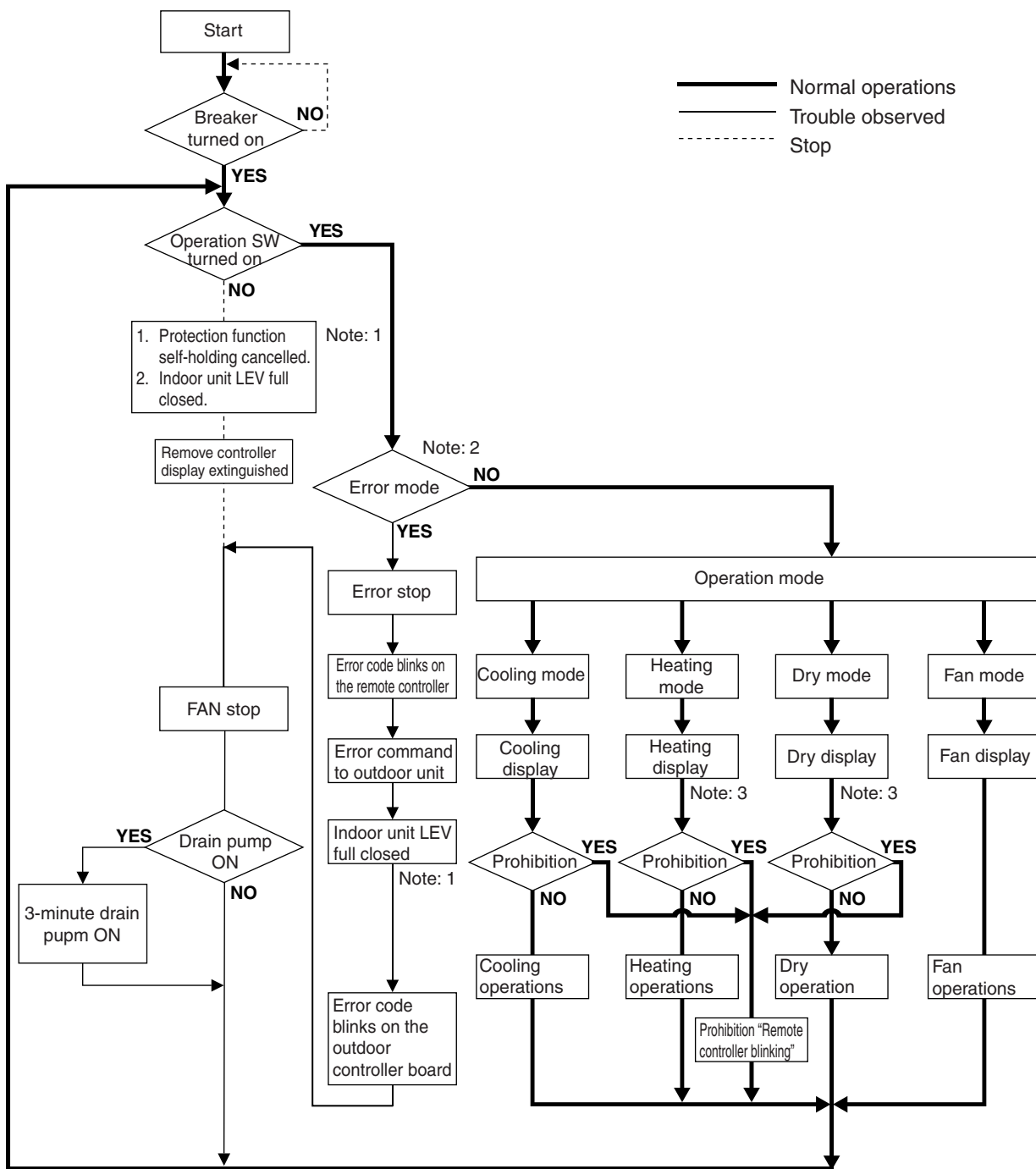

Note: 1	At indoor unit LEV full closed, the opening angle indicates 60.
Note: 2	The error mode includes that of indoor unit and that of outdoor unit. In the former case, the indoor unit in question only stops in error mood, while in the later case, all indoor units connected to the outdoor unit stop in error mode.
Note: 3	The operation mode follows the mode command from the indoor unit. However, when the outdoor unit is under cooling operation, the operation of the indoor unit will be prohibited even a part of indoor units or indoor unit under stopping or fan mode is put into heating mode. Contrarily, when the outdoor unit is under heating operation, the same condition will be commenced.

(3) Cooling operation

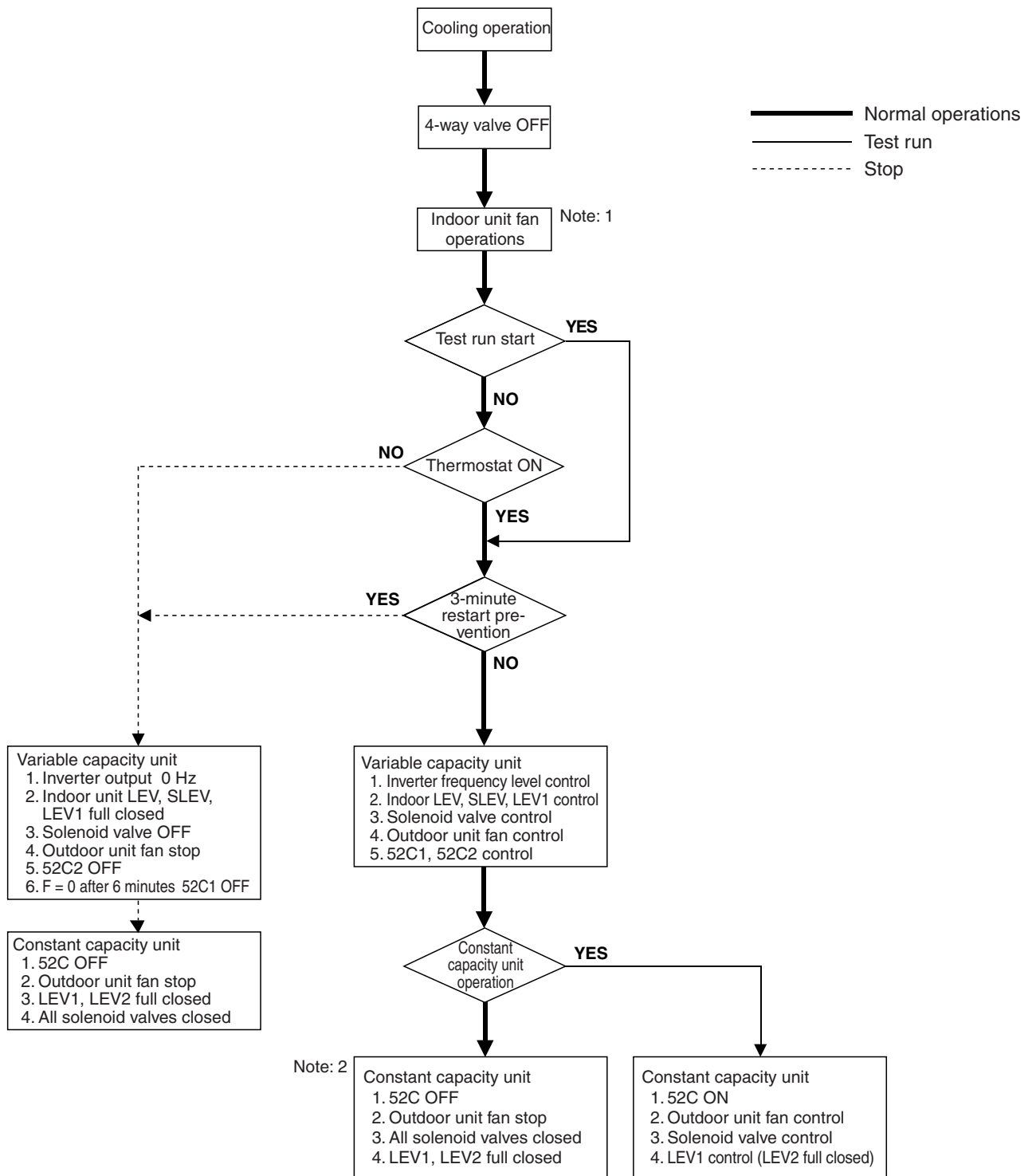

Note: 1	During cooling, indoor unit fan will operate at the set notch value whether the thermostat is ON or OFF.
Note: 2	Even when the constant capacity unit is stopped, the outdoor unit fan and the solenoid valves LEV1, LEV2 are sometimes operated.

(4) Heating operation

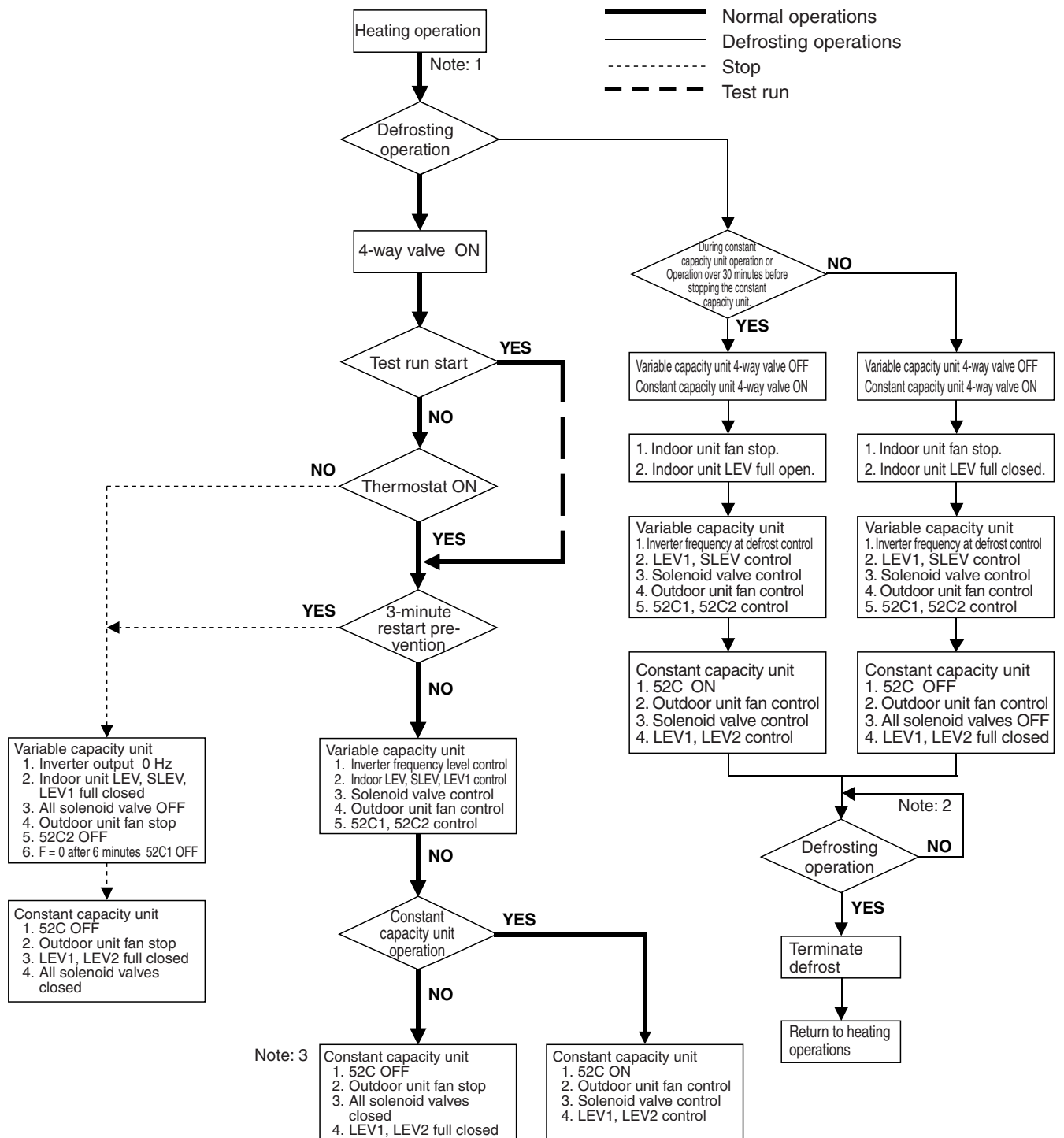

Note: 1	When the outdoor unit goes into defrost operations, a defrost operation command is sent to the indoor unit. Once the signal is received by the indoor unit, it too begins defrost operations. Defrost operation termination works in the same manner, with the indoor unit switching to heating operations after receiving the defrost operation termination command from the outdoor unit.
Note: 2	Conditions for defrost termination: After 15 minutes of defrost operations, or when the outdoor unit coil temperature is above 7°C.
Note: 3	Even when the constant capacity unit is stopped, the fan and the solenoid valves LEV1, LEV2 are sometimes operated.

(5) Dry operation

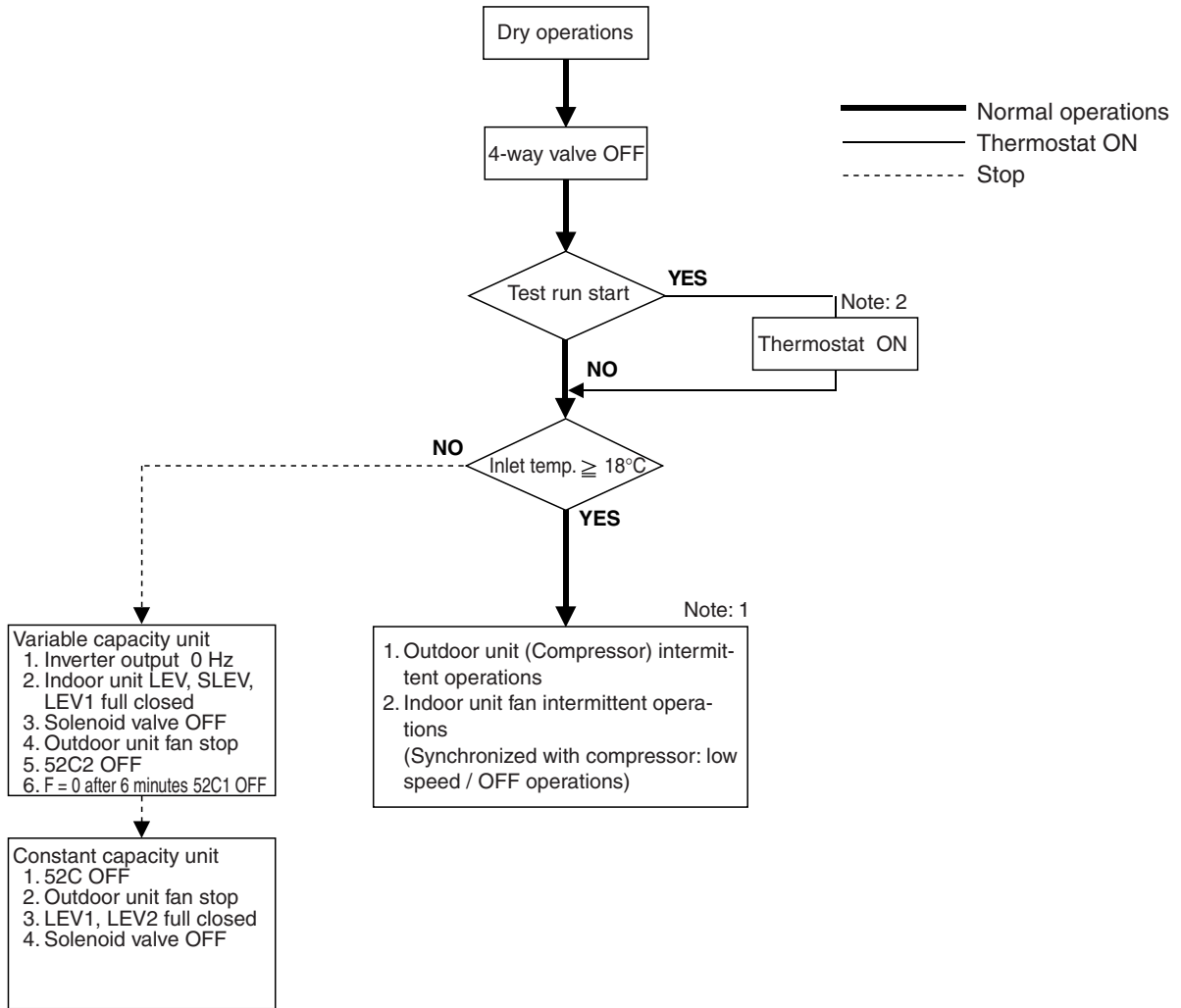

Note: 1	When indoor unit inlet temperature exceeds 18°C, outdoor unit (compressor) and indoor unit fan start intermittent operations synchronously. Operations of outdoor unit, indoor unit LEV and solenoid valve accompanying compressor are the same as those in cooling operations.
Note: 2	Thermostat is always kept on in test run, and indoor and outdoor unit intermittent operation (ON) time is a little longer than normal operations.

[3] List of Major Component Functions

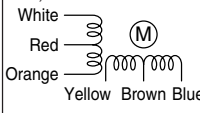
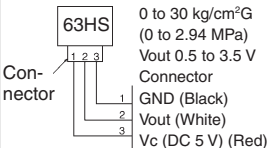
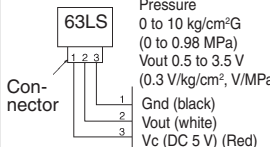
	Name	Code (Function)	Product code	Application	Specification	Inspection method
Indoor unit	Electronic expansion valve	LEV		① Adjustment of super heat of heat exchanger outlet port of indoor unit during cooling. ② Adjustment of sub-cool of heat exchanger outlet port of indoor unit during heating.	DC 12 V Amount of opening of the stepping motor drive valve 60 to 2000 pulse. (Gear Type)	Perform a continuity check using a tester. Conductivity among white, red and orange. Conductivity among yellow, brown and blue. 
	Thermistor	TH21 (Inlet air temperature)		Indoor unit control (Thermostat).	$R_0 = 15 \text{ k}\Omega$ $B_{0/80} = 3460$ $R_t = 15 \exp\{3460(\frac{1}{273+t} - \frac{1}{273})\}$	Resistance value check
		TH22 (Piping temperature)		① Indoor unit control (Freeze prevention, hot adjust, etc.). ② LEV control during heating (sub-cool detection).	0°C: 15 kΩ 10°C: 9.7 kΩ 20°C: 6.4 kΩ	
		TH23 (Gas piping temperature)		LEV control during cooling (super-heat detection).	25°C: 5.3 kΩ 30°C: 4.3 kΩ 40°C: 3.1 kΩ	
Outdoor unit (Variable capacity unit)	Compressor	MC1		Uses the operating pressure to adjust the operating frequency and adjust the amount of circulating refrigerant.	Low-pressure shell scroll type. Winding resistance 0.481 (20°C).	
		MC2		When there is a load that cannot be adjusted by MC1, this function ensures the stable flow of refrigerant.	Low-pressure shell scroll type. Winding resistance: each phase. 1.996 (20°C): 400 YMF-B 1.197 (20°C): 500 YMF-B 1.197 (20°C): P400-500 YMF-B	
	High pressure sensor	63HS		① Detects high-pressure pressure. ② Performs frequency control and high-pressure protection.		
	Low pressure sensor	63LS (PUHY-P400-500 YMF-B only)		1) Detects low-pressure. 2) Calculates the refrigerant circulation configuration. 3) Protects the low pressure		
	Pressure switch	63H1 62H2		① Detects high-pressure. ② Performs high-pressure protection.	Set to 30 kg/cm ² G (2.94 MPa) OFF.	Conductivity check
	Thermistor	TH11,12 (Outlet)		① Detects high-pressure pressure. ② Performs high-pressure protection.	0°C: 698 kΩ 60°C: 48 kΩ 10°C: 413 kΩ 70°C: 34 kΩ 20°C: 250 kΩ 80°C: 24 kΩ 30°C: 160 kΩ 90°C: 17.5 kΩ 40°C: 104 kΩ 100°C: 13.0 kΩ 50°C: 70 kΩ 110°C: 9.8 kΩ	$R_{120} = 7.465 \text{ k}\Omega$ $B_{25/120} = 4057$ $R_t = 7.465 \exp\{4057(\frac{1}{273+t} - \frac{1}{393})\}$
TH2 (Low pressure saturation temperature)			① Detects low pressure saturation temperature. ② Performs frequency control and liquid level of accumulator.	$R_0 = 33 \text{ k}\Omega$ $B_{0/100} = 3965$ $R_t = 33 \exp\{3965(\frac{1}{273+t} - \frac{1}{273})\}$	- 20°C: 92 kΩ - 10°C: 55 kΩ 0°C: 33 kΩ 10°C: 55 kΩ 20°C: 13 kΩ 30°C: 8.2 kΩ	Resistance check

Name	Code (Function)	Product code	Application	Specification	Inspection method
Outdoor unit (Variable capacity unit)	Thermistor	TH3 TH4 (Liquid level detection)	Detects liquid level of refrigerant inside accumulator using the differences among TH2, TH3, TH4.	$R_0 = 15 \text{ k}\Omega$ $B_{1/80} = 3460$ $R_t = 15 \exp\left\{3460\left(\frac{1}{273+t} - \frac{1}{273}\right)\right\}$	Resistance check
		TH5 (Liquid pipe temperature)	① Frequency control. ② Controls defrosting during heating. ③ Detects sub-cool of heat exchanger outlet using 63HS data and TH5 to control LEV1.	0°C: 15 kΩ 10°C: 9.7 kΩ 20°C: 6.4 kΩ 25°C: 5.3 kΩ 30°C: 4.3 kΩ 40°C: 3.1 kΩ	
	TH6 (Outdoor temperature)	① Detects the outdoor air temperature. ② Performs fan control, liquid level heater control, opening settings of LEV for oil return and other functions.	$R_0 = 15 \text{ k}\Omega$ $B_{1/80} = 3460$ $R_t = 15 \exp\left\{3460\left(\frac{1}{273+t} - \frac{1}{273}\right)\right\}$	Resistance check	
	TH7 TH8 TH9a (SC control)	Controls LEV using temperature differences among TH5, TH7, TH8 and TH9a.	0°C: 15 kΩ 10°C: 9.7 kΩ 20°C: 6.4 kΩ 25°C: 5.3 kΩ 30°C: 4.3 kΩ 40°C: 3.1 kΩ		
	TH9b (PUHY-P400-500 YMF-B only)	1) Detects the CS circuit fluid temperature. 2) Calculates the refrigerant circulation configuration.			
	TH10a TH10b Heat exchanger Gas temperature	Performs constant capacity unit LEV2 control by comparing the temperature difference with low pressure saturation temperature.			
	TH10c (PUHY-P400-500 YMF-B only)	1) Detects the compressor shell temperature. 2) Provides compressor shell overheating protection.	$R_{120} = 7.465 \text{ k}\Omega$ $B_{25/120} = 4057$ $R_t = 7.465 \exp_1\left\{4057\left(\frac{1}{273+t} - \frac{1}{273+120}\right)\right\}$ 20°C: 250 kΩ 70°C: 34 kΩ 30°C: 160 kΩ 80°C: 24 kΩ 40°C: 104 kΩ 90°C: 17.5 kΩ 50°C: 70 kΩ 100°C: 13.0 kΩ 60°C: 48 kΩ 110°C: 9.8 kΩ		
	THHS inverter heat sink temperature	Inverter cooling fan control using THHS temperature.	$R_{50} = 17 \text{ k}\Omega$ $B_{25/120} = 4170$ $R_t = 17 \exp\left\{4170\left(\frac{1}{273+t} - \frac{1}{323}\right)\right\}$ 0°C: 181 kΩ 10°C: 105 kΩ 20°C: 64 kΩ 25°C: 50 kΩ 30°C: 40 kΩ 40°C: 26 kΩ	Resistance check	
Solenoid valve	SV1 discharge-suction bypass	① Capacity control of high/low pressure bypass when starting and stopping. ② Discharge pressure rise suppression.	AC 220 to 240 V Open : conducting Close: not conducting	Conductivity test using tester	
	SV22 capacity control (full load)	Switching of capacity control valve inside No. 2 compressor (Switching between full load operation and unload operation) (All but model PUHY-400 YMF-B).	AC 220 to 240 V Close: conducting Open : not conducting		
	SV32 capacity control (unload)		AC 220 to 240 V Open : conducting Close: not conducting		
	SV4 discharge-suction bypass	Capacity control and controlling the rise of high-pressure (Back-up of frequency control).			

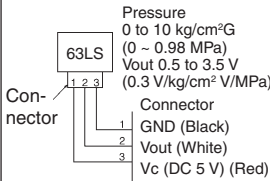
	Name	Code (Function)	Product code	Application	Specification	Inspection method
Outdoor unit (Variable capacity unit)	Solenoid valve	SV5b heat exchanger capacity control		Controls heat exchanger capacity of outdoor unit.	AC 220 to 240 V Close: conducting Open : not conducting	Conductivity test using tester.
		SV6 discharge-suction bypass		Evaporation of liquid refrigerant inside MC2.	AC 220 to 240 V Open : conducting Close: not conducting	
	Linear expansion valve	SLEV (Oil return)		Adjusts the rate of refrigerant (oil) returning from the accumulator.	DC 12V stepping motor drive valve opening amount 0 to 480 pulse (Direct drive type).	Same as indoor unit LEV. However, the resistance value is different than the indoor unit.
		LEV1 (SC coil)		Adjusts the bypass flow rate from the liquid piping of the outdoor unit during cooling.		
	Heater	CH11 CH12 crankcase heater		Refrigerant heating inside compressor.	Belt heater AC 200 to 240 V MC1 1280 Ω 45 W MC2 400: 1280 Ω 45 W 500: 1029 Ω 56 W	Resistance check
		CH2 CH3 Accumulator liquid level detection		Refrigerant heating of accumulator liquid level detection circuit.	Code heater 2880 Ω (1440 Ω + 1440 Ω) AC 220 to 240 V 20 W (10 W + 10 W)	Resistance check
4-way valve	21S4a		Switching of cooling/heating cycle.	AC 220 to 240 V Not conducting: cooling cycle Conducting : heating cycle	Conductivity check using tester.	
	21S4b		Controls heat exchanger capacity of outdoor unit.			
Outdoor unit (Constant capacity unit)	Compressor	MC		When there is a load that cannot be adjusted by the variable capacity unit, this function ensures the stable flow of refrigerant.	Low-pressure shell scroll type. Winding resistance: each phase 1.215 Ω (20°C) 8 HP 1.197 Ω (20°C) 10 HP	
	Pressure sensor	63LS		① Detect low-pressure pressure. ② Perform low-pressure pressure maintenance.		Conductivity check using tester.
	Pressure switch	63H		① Detects high pressure. ② Performs high pressure protection.	30 kg/cm²G (2.94 MPa) OFF setting	Conductivity check
	Thermistor	TH11 (Discharge)		① Detects discharge temperature. ② Performs high pressure protection.	R ₁₂₀ = 7.465 kΩ B _{25/120} = 4057 R _t = $7.465 \exp\{4057(\frac{1}{273+t} - \frac{1}{393})\}$	Resistance check
				0°C: 698 kΩ 60°C: 48 kΩ 10°C: 413 kΩ 70°C: 34 kΩ 20°C: 250 kΩ 80°C: 24 kΩ 30°C: 160 kΩ 90°C: 17.5 kΩ 40°C: 104 kΩ 100°C: 13.0 kΩ 50°C: 70 kΩ 110°C: 9.8 kΩ		
	TH3 TH4 (Liquid level detection)		Detects accumulator refrigerant levels by comparing the temperature differences between TH9, TH3 and TH4.	R ₀ = 15 kΩ B _{1/80} = 3460 R _t = $15 \exp\{3460(\frac{1}{273+t} - \frac{1}{273})\}$	Resistance check	
	TH5 (Pipe temperature)		① Frequency control. ② Defrost control during heating operations and liquid level detection. ③ Detects sub-cool of heat exchanger outlet using HPS data and TH5 to control LEV1.	0°C: 15 kΩ 10°C: 9.7 kΩ 20°C: 6.4 kΩ 25°C: 5.3 kΩ 30°C: 4.3 kΩ 40°C: 3.1 kΩ		

	Name	Code (Function)	Product code	Application	Specification	Inspection method
Outdoor unit (Constant capacity unit)	Themist	TH6 (Outdoor temperature)		① Detects the outdoor air temperature. ② Performs fan control, liquid level control, and oil-return LEV opening settings.	$R_0 = 15 \text{ k}\Omega$ $B_0/B_0 = 3460$ $R_t = 15 \exp\{3460(\frac{1}{273+t} - \frac{1}{273})\}$	Resistance check
		TH7 TH8 TH9 (SC control)		Controls LEV1 using temperature differences among TH5, TH7, TH8, and TH9.	0°C: 15 kΩ 10°C: 9.7 kΩ 20°C: 6.4 kΩ 25°C: 5.3 kΩ 30°C: 4.3 kΩ 40°C: 3.1 kΩ	
		TH10a Heat exchanger Gas temperature		Perform LEV2 control by comparing the temperature difference with low pressure saturation temperature.		
		TH10b (Pipe temperature)		Detect failure to open ball-valve by checking oil balance pipe temperature.		
	Solenoid Valve	SV1 Discharge – Suction Bypass		① Capacity control of high/low pressure bypass when starting and stopping. ② Discharge pressure rise suppression.	AC 220 to 240 V Open: conducting Close: not conducting	Conductivity check using tester.
		SV2 capacity control (full load)		Switching of capacity control valve inside No. 2 compressor (Switching between full load operation and unload operation) (PUHN-P200-250 YMF-B only).	AC 220 to 240 V Close: conducting Open: not conducting	
		SV3 capacity control (unload)			AC 220 to 240 V Open: conduction Close: not conducting	
		SV4 Discharge – Suction Bypass		Raise the internal pressure of the constant capacity accumulator.		
		SV5b Liquid pipes		Stop refrigerant inflow when the constant capacity unit is stopped.		
	Electronic expansion valve	LEV1 (SC coil)		Adjusts the bypass flow rate from the liquid piping of the outdoor unit during cooling.	DC 12 V stepping motor drive valve opening amount 0 to 480 pulse (Direct drive type)	Same as outdoor unit LEV. However the resistance value is different than the indoor unit.
		LEV2		Adjusts refrigerant flow rate in the constant capacity unit.		Same as indoor unit LEV.
	Heater	CH11 Crankcase heater		Refrigerant heating inside compressor.	Belt heater AC 200 to 240 V MC ... 200, 250: 1029 Ω 56 W	Resistance check
		CH2 CH3 Accumulator liquid level detection		Refrigerant heating of accumulator liquid level detection circuit.	Code heater 2880 Ω (1440 Ω + 1440 Ω) AC 220 to 240 V 20 W (10 W + 10 W)	
	4-way valve	21S4		Switching of cooling / heating cycle.	AC 220 to 240 V Not conducting: heating cycle Conducting : cooling cycle	Conductivity check using tester.

[4] Resistance of Temperature Sensor

Thermistor for low temperature

Thermistor $R_0 = 15 \text{ k}\Omega \pm 3\%$ (TH3 ~ 9a, 9b, 10a, 10b)

$$R_t = 15 \exp \left\{ 3460 \left(\frac{1}{273+t} - \frac{1}{273+0} \right) \right\}$$

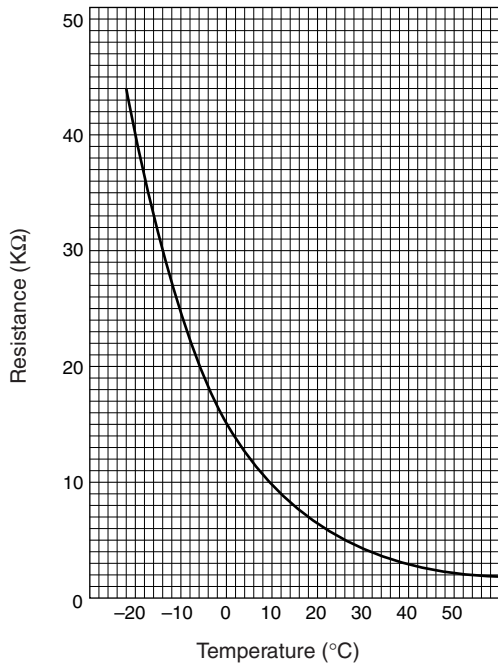

Thermistor $R_{120} = 7.465 \text{ k}\Omega \pm 2\%$ (TH11, 12, 10c)

$$R_t = 7.465 \exp \left\{ 4057 \left(\frac{1}{273+t} - \frac{1}{273+120} \right) \right\}$$

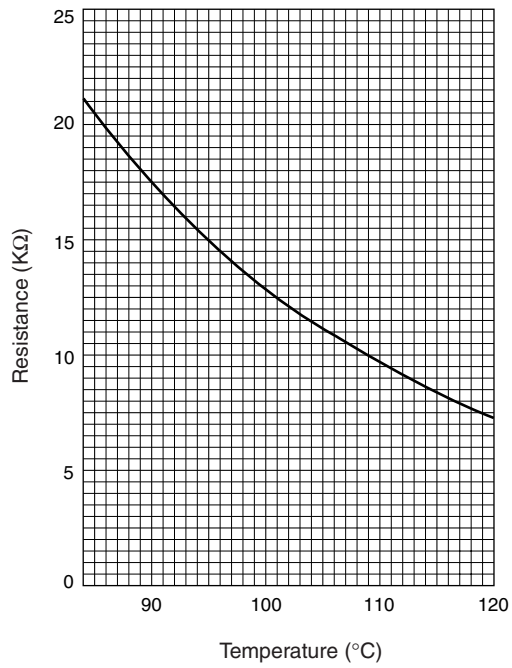

Thermistor $R_0 = 33 \text{ k}\Omega \pm 1\%$ (TH2)

$$R_t = 33 \exp \left\{ 3965 \left(\frac{1}{273+t} - \frac{1}{273+0} \right) \right\}$$

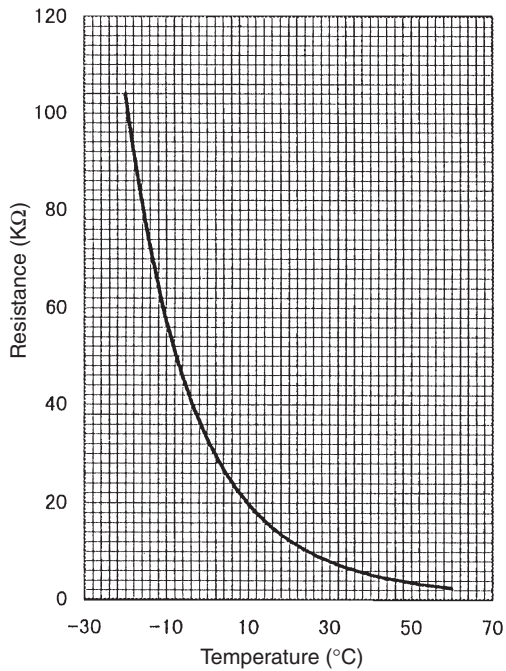

Thermistor $R_{50} = 17 \text{ k}\Omega \pm 2\%$ (THHS)

$$R_t = 17 \exp \left\{ 4170 \left(\frac{1}{273+t} - \frac{1}{273+50} \right) \right\}$$

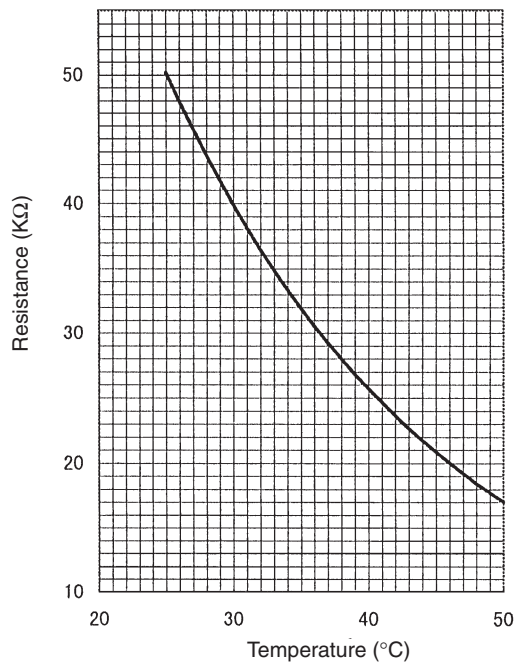

6 REFRIGERANT AMOUNT ADJUSTMENT

By clarifying the relationship between the refrigerant amount and operating characteristics for Super Y Series, conduct service activities such as decision on the amount and adjustment of refrigerant on the market.

[1] Operating Characteristics and Refrigerant Amount

The followings are operating characteristics and refrigerant amount which draw special attention.

1	During cooling operations, required refrigerant amount tends to increase (refrigerant in accumulator decreases) in proportion to increase in the number of operating indoor units. However, the change of increase rate is small.		
2	During heating operations, liquid level of accumulator is the highest when all the indoor units are operating.		
3	Discharge temperature hardly changes when increasing or decreasing refrigerant amount with accumulator filled with refrigerant.		
4	Tendency of discharge temperature	During cooling operations, discharge temperature tends to rise at overload than low temperature.	Comparison including control system
		During heating operations, discharge temperature tends to rise at low temperature than overload.	
		The lower operating frequency is, the higher discharge temperature tends to become because of deteriorated compressor efficiency.	
5	Compressor shell temperature is 20 ~ 70 degrees higher than low pressure saturation temperature (TH2) when refrigerant amount is appropriate. → Judged as over replenishment when temperature difference from low pressure saturation temperature (TH2) is 10 degrees or less.		

[2] Adjustment and Judgement of Refrigerant Amount

(1) Symptom

The symptoms shown in the table below are the signs of excess or lack of refrigerant amount. Be sure to adjustment amount in refrigerant amount adjustment mode, by checking operation status, judging refrigerant amount, and performing LED monitor display with LED, for overall judgement of excess or lack of refrigerant amount.

1	Error stop at 1500 remote controller display (excessive refrigerant replenishment)	Excessive refrigerant replenishment
2	Operating frequency does not fully increase, thus resulting in insufficient capacity	Insufficient refrigerant replenishment
3	Error stop at 1102 remote controller display (discharge temperature trouble)	
4	Error stop at 1501 remote controller display (low refrigerant trouble)	

(2) Refrigerant Volume

1) Checking the Operating Condition

Operate all the indoor units on cooling or on heating, checking the discharge temperature, sub-cooling, low pressure saturation temperature, inlet temperature, shell bottom temperature, fluid level, fluid step, etc. and rendering an overall judgment.

Note:

Depending on the operating state, AL = 0 has the meaning does not mean that there is insufficient refrigerant.

Condition		Judgment
1	Discharge temperature is high. (125°C or higher)	Refrigerant volume tends toward insufficient.
2	Low pressure saturation temperature is extremely low.	
3	Inlet superheating is high (if normal, SH = 20 deg. or lower).	
4	Shell bottom temperature is high (the difference with the low pressure saturation temperature is 70 deg. or greater)	
5	Shell temperature is low (the difference with the low pressure saturation temperature is 10 deg. or lower).	Refrigerant volume tends toward overcharge.
6	Liquid level AL = 2	

2) Cautions When Judging the Liquid Level

If you are judging the liquid level, be sure to use it only after making sure the liquid level sensor function (sensor and heater) is operating normally.

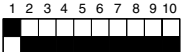
Check Items		Judgment
1	Liquid Heater Disconnection Check	Normal if the resistance is 2.8 kΩ ± 7 %.
2	Liquid Heater Output Check Turn 1 ON on the LED monitor display switch (SW1) ON  , and output the signal for the heater relay to LED 5, then check the voltage of the heater terminal (AC 198 ~ 264 V) (leave the heater connections as they are).	Normal if AC 198 ~ 264 V is output together with the LED lighting.
3	Use the LED monitor display to check if there is misalignment between the actual temperature and the detected temperature of TH2 ~ TH4.	

3) Check the refrigerant volume by LED monitor display using the LED.

Set the LED monitor display switch (SW1) as shown below and check the past information (history) concerning the refrigerant volume.

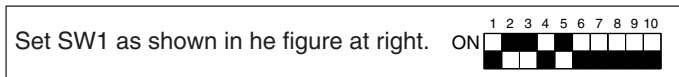

If LD3 lights up, it indicates the refrigerant charge abnormal delay state just before emergency stop due to refrigerant overcharge (1500).

(3) Additional Refrigerant Charge Volume

At the time of shipping from the factory, the outdoor unit is charged with the amount of refrigerant shown in the following table, but since no extension piping is included, please carry out additional charging on-site.

	Variable Capacity Unit		Constant Capacity Unit	
Outdoor Unit Model	PUHY-(P)400YMF-B	PUHY-(P)500YMF-B	PUHN-(P)200YMF-B	PUHN-(P)250YMF-B
Refrigerant Charge Volume	16 kg	22 kg	6.5 kg	8.5 kg

Calculation Formula

Calculate the additional refrigerant volume by calculating the size of the extension liquid piping and its length (units: m).

$$\text{Additional Refrigerant Volume (kg)} = (0.29 \times L_1) + (0.25 \times L_2) + (0.12 \times L_3) + (0.06 \times L_4) + (0.024 \times L_5) + \alpha$$

In the calculation results, round up fractions smaller than 0.01 kg. (Example: 18.54 kg → 18.6 kg)

(α Calculation Table)

Total Capacity of Connected Indoor Units	α
161 ~ 330	2.0 kg
331 ~ 480	2.5 kg
481 ~ 630	3.0 kg
631 ~	4.0 kg

L1: Length of φ19.05 liquid pipe (m)

L2: Length of φ15.88 liquid pipe (m)

L3: Length of φ12.7 liquid pipe (m)

L4: Length of φ9.52 liquid pipe (m)

L5: Length of φ6.35 liquid pipe (m)

α: refer to the calculation table.

Example PUHY-P600YSMF-B

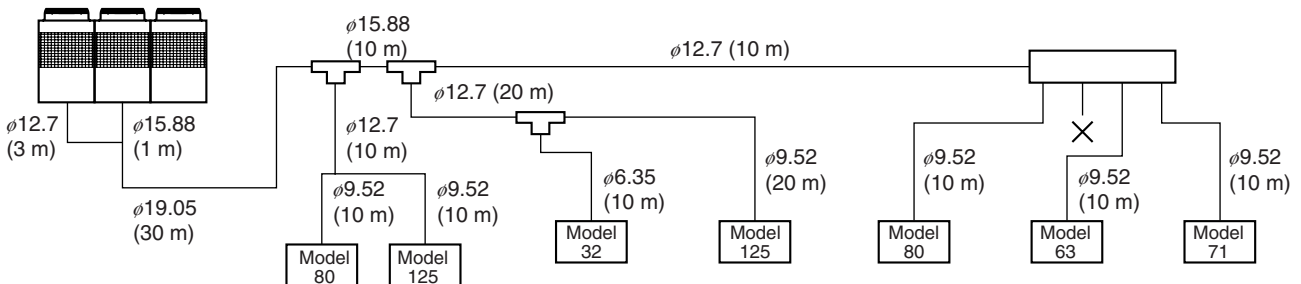

Each distribution pipe carries liquid.

φ19.05: 30 m	= 30 m
φ15.88: 1 m + 10 m	= 11 m
φ12.7 : 3 m + 10 m + 20 m + 10 m	= 43 m
φ9.52 : 10 m + 10 m + 20 m + 10 m + 10 m + 10 m	= 70 m
φ6.35 : 10 m	= 10 m

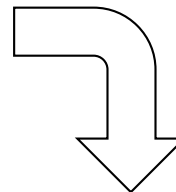

From the formula above we find that:

$$\text{Add. Refrigerant volume} = (0.29 \times 30) + (0.25 \times 11) + (0.12 \times 43) + (0.06 \times 70) + (0.024 \times 10) + 3 = 24.05 \text{ kg}$$

The result of this calculation is 24.05 kg, however we will round to the nearest 0.1 kg:

$$\text{Add. Refrigerant volume} = 24.1 \text{ kg.}$$

The total refrigerant level (including the outdoor unit refrigerant charge and the additional volume in the extension pipes) is over 73 kg, please make the total refrigerant amount = 73 kg.

$$\text{Original refrigerant amount in the outdoor unit} + \text{additional refrigerant amount} \leq 73 \text{ kg}$$

Example for PUHY-P600YSMF-B

PUHY-P400YMF-B	+	PUHN-P200YMF-B	+	Additional refrigerant volume	=	
16 kg		6.5 kg		51 kg		73.5 kg

→ Fix to 73 kg

(Set the additional refrigerant volume to 50.5 kg.)

⚠ Caution: (R407C)

When charging with refrigerant, be sure to charge from the liquid side. If charging from the gas side, it will cause the refrigerant composition to change inside the unit and the composition of the refrigerant remaining in the canister will also change.

[3] Refrigerant Volume Adjustment Mode Operation

(1) Procedure

Depending on the operating conditions, it may be necessary either to charge with supplementary refrigerant, or to drain out some, but if such a case arises, please follow the procedure given below.

① Switching the function select switch (SW2-4), located on the outdoor unit's control board, ON starts refrigerant volume adjustment mode operation and the following operation occurs. (Refrigerant recovery mode and oil recovery mode will be invalid.)

② Additionally, if the LED monitor display switch (SW1) on the outdoor unit's control board is set to ON , the accumulator's liquid level is indicated by the LED lighting position.

AL = 0 (No fluid in accumulator)
AL = 1 (Liquid in accumulator)
AL = 2 (Overcharge)

Note 1: Even if AL = 1 for a short time after operation in the refrigerant volume adjustment mode starts, as time passes (as the refrigeration system stabilizes), it may change to AL = 0.

① If it is really AL = 1

Cases where AL = 1, TH5 - TH7 in the outdoor unit is 5 deg. or greater and the SH of all indoor units is 6 ~ 13 deg.

② Cases where AL = 1 now, but there is a possibility that it will change to AL = 0 as time passes.

TH5 - TH7 in the outdoor unit is not 5 deg., or the SH of at least one of the indoor units is not deg.

Note 2: A refrigerant volume adjustment performed in the cooling mode must be done with a gauge reading of 14 kg/cm²G (1.37 MPa) or higher.

If the pressure does not reach 14 kg/cm²G (1.37 MPa), adjust in the heating mode.

Note 3: In cooling mode, use TH11, TH12, TH5, TH7 and Tc (Saturation temperature of pressure sensor data of 63HS) to adjust the refrigerant volume. TH11, TH12, TH5 and TH7 can be displayed using the LED monitor display switch (SW1) on the outdoor unit's control board.

Note 4: Judgment by the AL is at best only a rough guideline. Please do not add refrigerant based on the AL reading alone. (Be sure to obtain calculations of the correct amount before adding refrigerant.)

TH11 LED monitor display Switch



TH12 LED monitor display Switch



TH5 LED monitor display Switch



TH7 LED monitor display Switch



63HS LED monitor display Switch



Tc LED monitor display Switch



Using these, judge TH1, Tc - TH5 and Tc - TH7.

Treatment	A	In cases where cooling is being done in the refrigerant volume adjustment mode, if ② above applies, please perform accumulator level AL judgment after waiting until TH5 - TH7 in the outdoor unit is at 5 deg. or higher and the SH of all the indoor units reaches 2 ~ 5 deg.
	C	For the SH of indoor units, turn the LED monitor display switch for the outdoor unit ON, then monitor by the lighting position of the LED.

(2) Refrigerant adjustment in cooling season (Flow chart)
PUHY-(P) 400-500 YMF-B

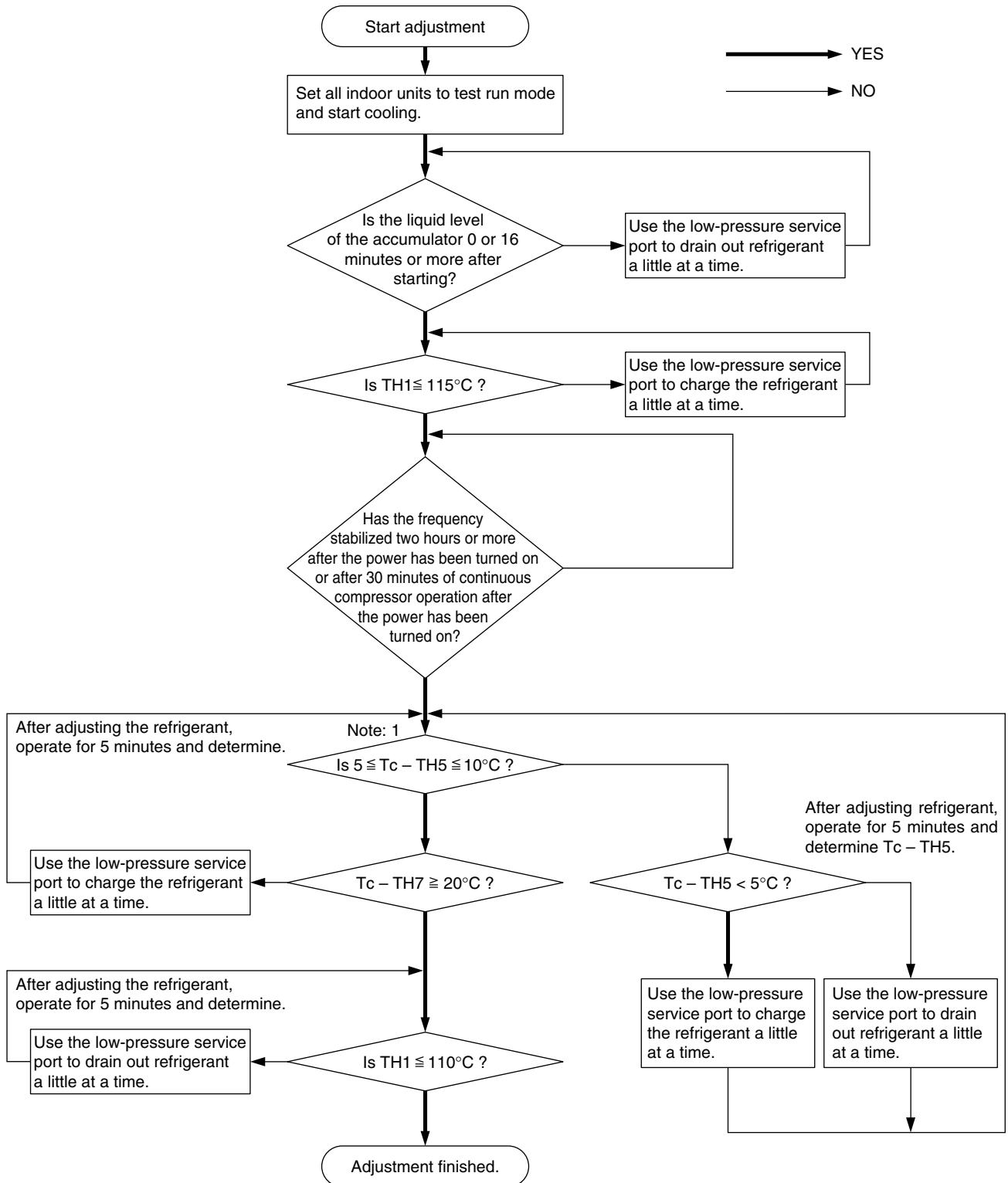

⚠ Caution:
 Do not let the drained out refrigerant escape to the outside atmosphere.
 • Always be sure to charge with refrigerant from the liquid phase side.(R407C)

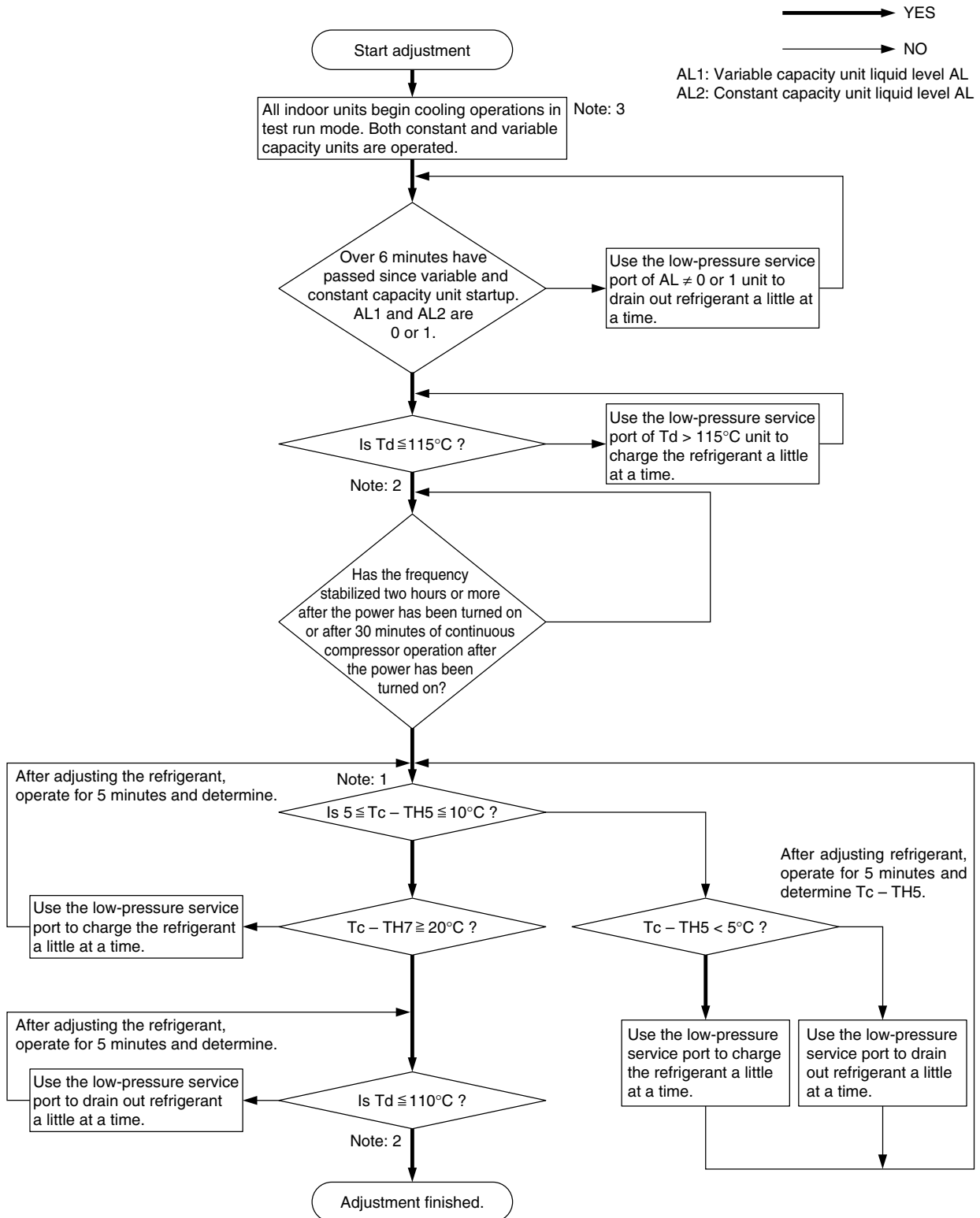

Note: 1	Convert Tc to saturation temperature Tc using the variable capacity unit high-pressure saturation temperature conversion chart. Determine Tc-TH5, Tc-TH7 on the variable capacity unit.
Note: 2	Please perform Td determination on both the variable and constant capacity units. Td: Variable capacity unit TH11, TH12 (Turn all SW4-2 OFF to display these temperature data) Constant capacity unit. TH11 (Turn SW4-2 ON to display these temperature data)
Note: 3	Perform this adjustment while both the variable and constant capacity units are in operation. The constant capacity unit compressor will not operate before the initial start mode is finished.

⚠ Caution:

- Do not let the drained out refrigerant escape to the outside atmosphere.
- Always be sure to charge with refrigerant from the liquid phase side. (R407C)

(3) Refrigerant adjustment in heating season (Flow chart)
PUHY-(P) 400-500 YMF-B

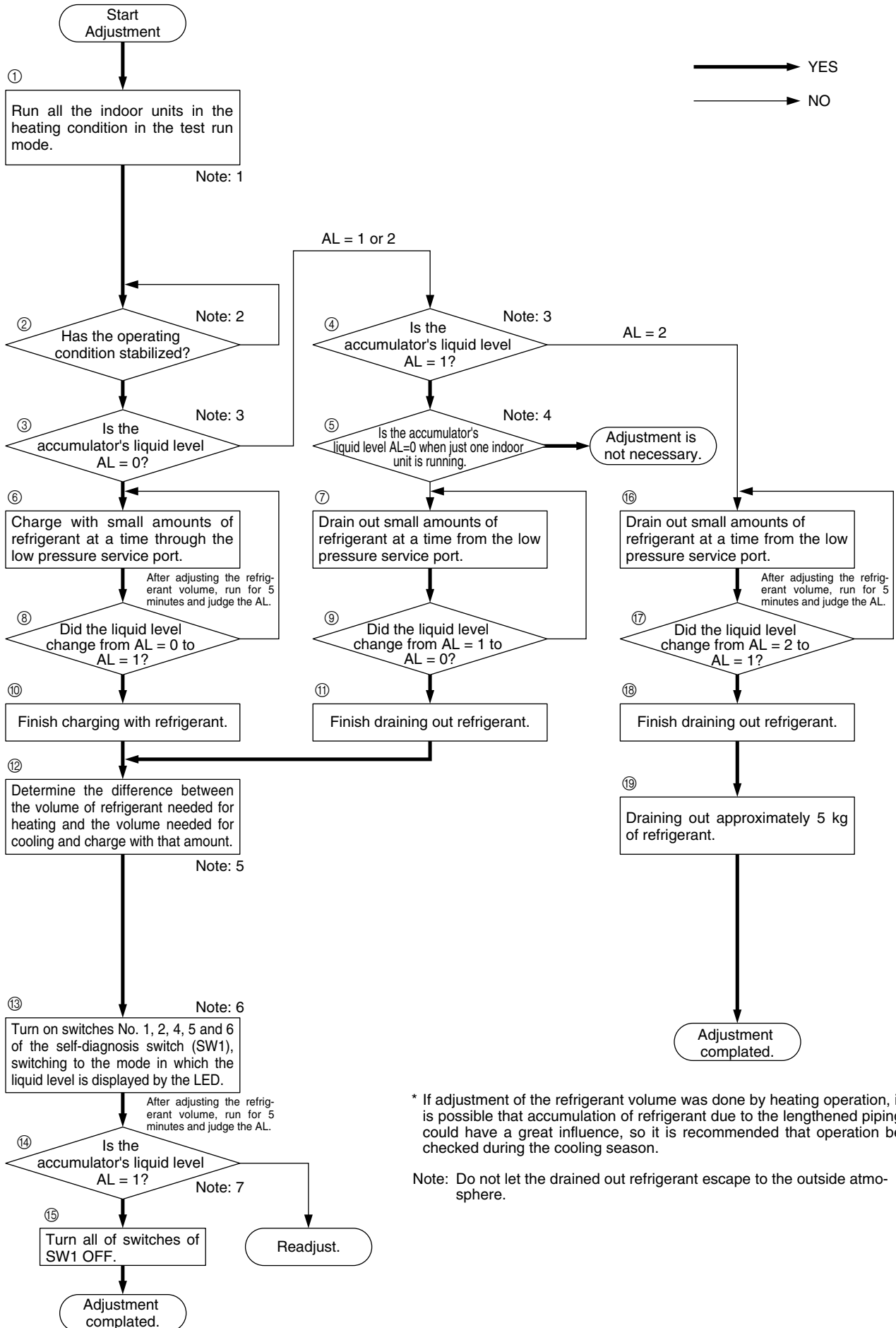

Note: 1 If there are any units which are not operating, it will cause refrigerant to accumulate, so by all means operate all the indoor units. Also, in order to prevent stable operation from being disrupted by the thermostat going OFF, set the trial operation mode.

Note: 2 If the high pressure is stabilized, it is safe to judge that the operation condition is stable.
Judge that operation is stabilized or not stabilized by whether the compressor starts after 3 or more minutes have passed.

Note: 3 When turning on SW1 to ON , the LED will display the liquid level.

SW4-2 OFF: Variable Capacity Unit AL Display

SW4-2 ON : Constant Capacity Unit AL Display

Note: 4 If AL = 1, it indicates basically that adjustment is not necessary, but when the liquid level is on the low side even if it is in the AL = 1 region, if one unit only is run and refrigerant is accumulating in the units that are stopped, it may result in there being insufficient refrigerant, so at such a time, adjustment is necessary.

Note: 5 Determine the difference in the volume of refrigerant necessary for cooling and for heating as follows, and carry out supplementary charging in accordance with the table below.

* The piping length is the total pipe length calculated for a liquid pipe with a $\phi 19.05$ size.

Pipe Length	60 m or less	60 ~ 90 m	90 m or longer
Additional Refrigerant Volume	19 kg	24 kg	29 kg

If the liquid pipe size is $\phi 15.88$, the actual length is 0.85
If the liquid pipe size is $\phi 12.7$, the actual length is 0.4
If the liquid pipe size is $\phi 9.52$, the actual length is 0.2
If the liquid pipe size is $\phi 6.35$, the actual length is 0.1

Note: 6 When turning on SW 1 to ON , the LED will display the liquid level (AL).

SW4-2 OFF: Variable Capacity Unit AL Display

SW4-2 ON : Constant Capacity Unit AL Display

Note: 7 Middle capacity operation refers to the smallest indoor unit operation capacity attainable with the constant capacity Unit. Unlike the outdoor unit models, operate about 70 % of the indoor units when operating the constant capacity unit.

Note: 8 With Super Y, liquid refrigerant correction control will begin after there has been an preliminary overcharged refrigerant abnormality (Code 1600).

To determine whether there will be liquid refrigerant correction control, turn SW1-3 ON. (During control, one of LD2 through LD8 will Blink.)

Note: 9 In the case of the PUHY-(P)400-500 YMF-B

If the adjustments in ⑥ ~ ⑩ are sure, even if the refrigerant is supplied in ⑫ until the maximum refrigerant level is reached, it will not become AL = 2. Therefore, in the case of AL = 2, replenishment is cone at ⑥ and ⑧, or it can be judged that there was a calculation mistake in ⑫.

(4) R22 Gauge pressure - saturation temperature conversion chartkg/cm²G — °C

Pressure→ ↓	0	0.1	0.2	0.3	0.4	0.5	0.6	0.7	0.8	0.9
1	-25.2	-24.0	-22.8	-21.7	-20.7	-19.6	-18.6	-17.6	-16.7	-15.7
2	-14.8	-14.0	-13.1	-12.2	-11.4	-10.6	-9.8	-9.1	-8.3	-7.6
3	-6.8	-6.1	-5.4	-4.7	-4.1	-3.4	-2.7	-2.1	-1.5	-0.8
4	-0.2	0.4	1.0	1.6	2.1	2.7	3.3	3.8	4.4	4.9
5	5.5	6.0	6.5	7.0	7.5	8.0	8.5	9.0	9.5	10.0
6	10.5	10.9	11.4	11.9	12.3	12.8	13.2	13.7	14.1	14.5
7	15.0	15.4	15.8	16.2	16.6	17.0	17.5	17.9	18.3	18.7
8	19.1	19.4	19.8	20.2	20.6	21.0	21.3	21.7	22.1	22.5
9	22.8	23.2	23.5	23.9	24.3	24.6	25.0	25.3	25.7	26.0
10	26.3	26.7	27.0	27.3	27.7	28.0	28.3	28.7	29.0	29.3
11	29.6	29.9	30.2	30.6	30.9	31.2	31.5	31.8	32.1	32.4
12	32.7	33.0	33.3	33.6	33.9	34.2	34.5	34.8	35.1	35.3
13	35.6	35.9	36.2	36.5	36.8	37.0	37.3	37.6	37.9	38.1
14	38.4	38.7	38.9	39.2	39.5	39.7	40.0	40.3	40.5	40.8
15	41.0	41.3	41.5	41.8	42.1	42.3	42.6	42.8	43.1	43.3
16	43.6	43.8	44.0	44.3	44.5	44.8	45.0	45.2	45.5	45.7
17	45.9	46.2	46.4	46.7	46.9	47.1	47.3	47.6	47.8	48.0
18	48.3	48.5	48.7	48.9	49.2	49.4	49.6	49.8	50.1	50.3
19	50.5	50.7	50.9	51.2	51.4	51.6	51.8	52.0	52.3	52.4
20	52.6	52.9	53.1	53.3	53.5	53.7	53.9	54.1	54.3	54.5
21	54.7	54.9	55.1	55.3	55.5	55.7	55.9	56.1	56.3	56.5
22	56.7	56.9	57.1	57.3	57.5	57.7	57.9	58.1	58.3	58.5
23	58.7	58.9	59.0	59.2	59.4	59.6	59.8	60.0	60.2	60.4
24	60.5	60.7	60.9	61.1	61.3	61.5	61.6	61.8	62.0	62.2
25	62.4	62.5	62.7	62.9	63.1	63.3	63.4	63.6	63.8	64.0
26	64.1	64.3	64.5	64.7	64.8	65.0	65.2	65.4	65.5	65.7
27	65.9	66.0	66.2	66.4	66.5	66.7	66.9	67.0	67.2	67.4
28	67.5	67.7	67.9	68.0	68.2	68.4	68.5	68.7	68.9	69.0
29	69.2	69.3	69.5	69.7	69.8	70.0	70.1	70.3	70.4	70.6
30	70.9	71.1	71.2	71.3	71.4	71.5	71.7	71.9	72.0	72.2
31	72.3	72.5	72.6	72.8	72.9	73.1	73.2	73.4	73.5	73.7

If the unit for the gauge pressure is MPa, multiply the gauge pressure by 10 when using the table.

In the case of R407C, the values in the table above cannot be used.

7 TROUBLESHOOTING

[1] Principal Parts

(1) Judging Failure

Pressure Sensor (Discharge/Suction Pressure Sensor)

- 1) Check for failure by comparing the sensing pressure according to the high pressure/low pressure sensor and the pressure gauge pressure.
Turn on switches 2, 4, 5, 6 (High) and 1, 2, 4, 5, 6 of the digital display select switch (MAIN board SW1) as shown below, and the pressure sensor is displayed digitally by the light emitting diode LD1.



- 1 In the stopped condition, compare the pressure readings from the gauge and from the LD1 display.
 - (a) If the gauge pressure is 0 ~ 1 kg/cm²G (0.098 MPa), the internal pressure is dropping due to gas leakage.
 - (b) If the pressure according to the LD1 display is 0 ~ 1 kg/cm²G (0.098 MPa), there is faulty contact at the connector, or it is disconnected. Proceed to 4.
 - (c) If the pressure according to the LD1 display is 32 kg/cm²G (3.14 MPa) or higher, proceed to 3.
 - (d) If other than (a), (b) or (c), compare the pressure readings during operation. Proceed to 2.
- 2 Compare the pressure readings from the gauge and from the LD1 display while in the running condition.
 - (a) If the difference between the two pressures is within 1 kg/cm²G (0.098 MPa), both the affected pressure sensor and the main MAIN board are normal.
 - (b) If the difference between the two pressures exceeds 1 kg/cm²G (0.098 MPa), the affected pressure sensor is faulty (deteriorating performance).
 - (c) If the pressure reading in the LD1 display does not change, the affected pressure sensor is faulty.
- 3 Disconnect the pressure sensor from the MAIN board and check the pressure according to the LD1 display.
 - (a) If the pressure is 0 ~ 1 kg/cm²G (0.098 MPa) on the LD1 display, the affected pressure sensor is faulty.
 - (b) If the pressure is 32 kg/cm²G (3.14 MPa) or higher, the MAIN board is faulty.
- 4 Disconnect the pressure sensor from the MAIN board and short out the No. 2 and No. 3 pins of the connector (63HS), then check the pressure by the LD1 display.
 - (a) If the pressure according to the LD1 display is 32 kg/cm²G (3.14 MPa) in the case of the low pressure sensor, 10 kg/cm²G (0.98 MPa) or higher, the affected pressure sensor is faulty.
 - (b) If other than (a), the MAIN board is faulty.

2) Pressure sensor configuration.

The pressure sensors are configured in the circuit shown in the figure at right. If DC 5 V is applied between the red and black wires, a voltage corresponding to the voltage between the white and black wires is output and this voltage is picked up by the microcomputer. Output voltages are as shown below.

High Pressure 0.1 V per 1 kg/cm²G
(0.098 MPa)

Low Pressure 0.3 V per 1 kg/cm²G
(0.098 MPa)

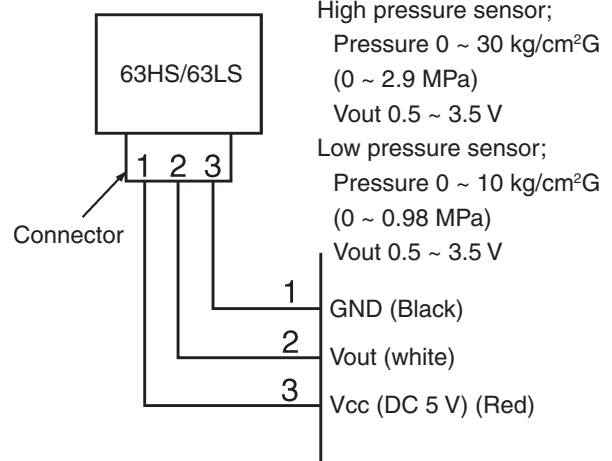

- Connector connection specifications on the pressure sensor body side.

The connector's pin numbers on the pressure sensor body side differ from the pin numbers on the main circuit board side.

	Sensor Body Side	MAIN Board Side
Vcc	Pin 1	Pin 3
Vout	Pin 2	Pin 2
GND	Pin 3	Pin 1

Solenoid Valve

● Variable Capacity Unit Valves (SV1, SV22, SV32, SV4, 21S4a, 21S4b, SV5b, SV6)

Check if the control board's output signals and the operation of the solenoid valves match.

Setting the LED monitor display switch (SW1) as shown in the figure below causes the ON signal of each relay to be output to the LED's.

* When monitoring the variable capacity unit, set SW4-2 OFF.

Each LED shows whether the relays for the following parts are ON or OFF. When a LED lights up, it indicates that the relay is ON.

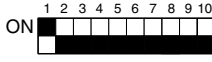
SW1	LED							
	1	2	3	4	5	6	7	8
	Compressor Operating	52C1	52C2	21S4a	SV1		SV22, 32 (ON : un-load) (OFF: full-load)	Lights up all the time
	SV4	21S4b	SV5b	SV6	CH2, 3 liquid heater	52F		

Use care as the solenoid valve and the front and rear piping can be hot.

1) SV1 (Bypass valve)

- ① Since SV1 will be set to ON 4 minutes after the compressor has started operation, confirm operation by monitoring the LED display and listening for the operation of the solenoid valve.
- ② It is possible to confirm the switching being performed by the operation of the solenoid valve while the unit is operating by monitoring the temperature of the bypass circuit or the sound of the refrigerant.

2) SV22, SV32 (Full load/unload switching valve) (All but model PUHY-400YMF-B)

- ① The No. 1 compressor is started first and operates for approximately 10 minutes and then the No. 2 compressor starts in the unload mode. Since it will then switch to full load within 5 minutes, the operation can be confirmed by the LED display and the operating temperature of the solenoid valve. (If the indoor unit operating is small, the No. 2 compressor will not start.)
- ② It is possible to determine whether or not the compressors are switching from unload to full load by check the changes in amperage of the compressor at the moment of switching. The amperage under full load will be approximately 30 to 40 % more than operation under unload.

Note: The solenoid valve for SV22 is closed when conducting electricity while the SV32 is open when conducting electricity.

3) SV4 (Bypass valve)

- ① During unload operation in the cooling mode and when there is a rise in temperature and during unload operation in the heating mode, SV4 will be set to ON according to conditions, making is possible to check operation by the LED display and the operating sound of the solenoid valve.
- ② It is possible to confirm the switching for the operating status by the temperature of the bypass circuit or the sound of the refrigerant during the operation of the solenoid valve.

4) SV5b

- ① During cooling when operating at somewhat above the capacity of the indoor unit, SV5b will be set to OFF, making it is possible to confirm operation by monitoring the LED display and listening to the operating sound.
- ② During heating, the SV5b is a 2-way valve that is closed when conducting electricity and open when not conducting electricity.

5) SV6

When No. 2 compressor is operating and No. 2 compressor is stopped, the main SV6 will be set to ON, making it possible to confirm operation by monitoring the LED display and listening to the operating sound. Note that it may be set to OFF if the outlet temperature (TH11) exceeds 120°C .

6) 21S4a

This 4-way switching valve operates as follows.

Not conducting : There is conductivity between the outlet port of the oil separator and the heat exchanger (HEX1a, 2a: the heat exchanger to the right when facing the front of the unit) and between the gas ball valve (BV1) and accumulator, forming the cooling cycle circuit.

Conducting : There is conductivity between the oil separator and the gas ball valve and between the heat exchanger and accumulator, forming the heating cycle circuit.

It is possible to determine whether or not there is normal operation by monitoring the LED display and the temperature of the inlet and outlet ports of the 4-way switching valve at that time. By monitoring these, it is possible to determine the areas where there is conductivity. Do not confirm the temperature of the piping on the oil separator side by touching it. It is extremely hot.

* Prevent the outside from receiving impact. If the outer ring becomes deformed, the inner valve will not operate properly.

7) 21S4b

This 4-way switching valve operates as follows.

Not conducting : There is conductivity between the outlet port of the oil separator and the heat exchanger (HEX1b, 2b: the heat exchanger to the left when facing the front of the unit).

Conducting : There is conductivity between the heat exchanger and the accumulator.

The heat exchanger circuit opens and closes during cooling and heating.

While it is possible to determine whether or not there is normal operation by monitoring the LED display and the sound of the switching, the switching of the 21S4a during heating is heavier, which could make confirmation by sound more difficult. At this time, it is possible to determine the areas where there is conductivity by the temperature of the inlet and outlet temperatures of the 4-way switching valve. Do not confirm the temperature of the piping on the oil separator side by touching it. It is extremely hot.

* Prevent the outside from receiving impact. If the outer ring becomes deformed, the inner valve will not operate properly.

● Constant Capacity Unit Valves (SV1, SV2, SV3, SV4, SV5b)

Check if the control board's output signals and the operation of the solenoid valves match.

Setting the LED monitor display switch (SW1) as shown in the figure below cases the ON signal of each relay to be outputted to the LEDs.

* When monitoring the constant capacity unit, set SW4-2 ON.

Each LED shows whether the relays for the following parts are ON or OFF. When a LED lights up, it indicates that the relay is ON.

SW1		SW4-2	LED							
1	2		3	4	5	6	7	8		
0000000000	ON	Compressor Operating	52C1		21S4-1	SV1		SV2, 3 (PUHN-P-YMF-B only)	Lights up all the time	
1000000000	ON	SV4		SV5b		CH2, 3	52F			

1) SV1 (Bypass Solenoid Valve)

This solenoid valve opens when conductive (relay ON).

- ① Since SV1 will be set to ON 3 minutes after the constant capacity unit compressor has started operation, confirm operation by monitoring the LED display and listening for the operation sound of the solenoid valve.
- ② By measuring the changes in temperature of the SV1 outflow pipe while it is conducting, it can be determined whether the valve is open or closed. When the valve is open hot gas will flow down the pipe, so do not check it by touch. (Since the parallel capillaries will still carry hot gas when the valve is shut, the outflow pipe will always be hot).

2) SV2, 3 (Full-load / Un-load switching valve) PUHN-P-YMF-B only

- ① It starts in un-load in the initial start mode and during defrosting, and starts in full-load at all other times.
- ② It is possible to determine whether or not the compressors are switching from un-load to full load by check the changes in amperage of the compressor at the moment of switching. The amperage under full load will be approximately 30 to 40 % more than operation under un-load.

Note: The solenoid valve for SV2 is closed when conducting electricity while the SV3 is open when conducting electricity.

3) SV4 (Bypass Solenoid Valve)

This solenoid valve opens when conductive (relay ON).

Operations can be confirmed by the LED display and the operating sound.

Solenoid valve switches in the operation mode can be confirmed by the temperature of the solenoid valve outflow circuit, and the refrigerant sound.

When the valve is open, hot gas will flow through the pipe, so do not check it by touching.

4) SV5b (Liquid Distribution Pipe Solenoid Valve)

This solenoid valve opens when conductive (relay ON).

It is possible to confirm operation by monitoring the LED display and listening to the operating sound.

(operation conditions: when the constant capacity unit is heating or performing liquid refrigerant correction control mode)

It is possible to confirm operation switches made by solenoid valve operation by the refrigerant sound or the temperature of the solenoid valve outflow circuit.

Outdoor Unit Fan

1) Variable Capacity Unit

- Since the fan for the outdoor unit is controlled by phase control, check the fan speed by monitoring the output status of the phase control output on the LED display. At full speed, the fan revolves at approx. 600 r/min.
- The fan will take 5 seconds to reach full speed when starting from a stop.
- Because the variable capacity unit has two fans, it may take 10 seconds for them to reach full speed.
- On the variable capacity unit, the fan on the right is usually operated, with the left fan only being used in case of demand. (When heating, both fans are used except for during defrosting operations).
- When the LED No. 70 FANCON output reads 100 %, the fan stops. At 0 % it will run at full speed.
- The fan speed may be modified by control.
- When a fan does not move, or produces irregular vibrations, this could be a triac problem, or the fan motor in open phase or reverse phase operation. (Open phase or reverse phase irregularities in the main power source will be detected by the MAIN board. However, these problems could result from the replacement of damaged fan-motor leads during a service check.)
- When only one fan is operating, after checking the 52F output on the LED monitor, check for mis-aligned fan connectors, mis-aligned 52F connectors, or a possible break in a lead line.

2) Constant Capacity Unit

- Fan operation is almost identical to that in the variable capacity unit, with the following differences:
- The fan will operate while the constant capacity unit No.3 compressor is operating.
- Even when the No.3 compressor is stopped, the fan will sometimes be operated to prevent refrigerant from pooling in the heat exchanger.
- The fan will run for a maximum of 15 minutes after the No.3 compressor has stopped.

Outdoor LEV

The valve opening angle changes in proportion to the number of pulses.

(Connections between the outdoor unit's MAIN board and SLEV, LEV1, LEV2 (outdoor electronic expansion valve).)

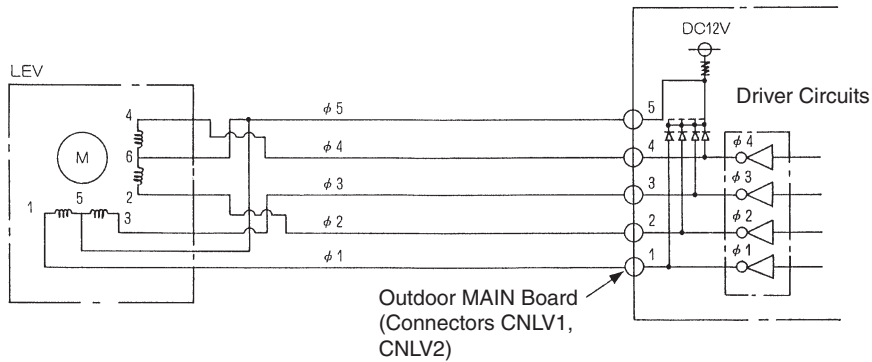

① SLEV, LEV1

Pulse Signal Output and Valve Operation

Output (Phase) No.	Output State							
	1	2	3	4	5	6	7	8
φ1	ON	OFF	OFF	OFF	OFF	OFF	ON	ON
φ2	ON	ON	ON	OFF	OFF	OFF	OFF	OFF
φ3	OFF	OFF	ON	ON	ON	OFF	OFF	OFF
φ4	OFF	OFF	OFF	OFF	ON	ON	ON	OFF

Output pulses change in the following orders when the Valve is Closed 1 → 2 → 3 → 4 → 5 → 6 → 7 → 8 → 1
Valve is Open 8 → 7 → 6 → 5 → 4 → 3 → 2 → 1 → 8

- * 1. When the LEV opening angle does not change, all the output phases are off.
- * 2. When the output is out of phase or remains ON continuously, the motor cannot run smoothly, but move jerkily and vibrates.

LEV Valve Closing and Valve Opening Operations

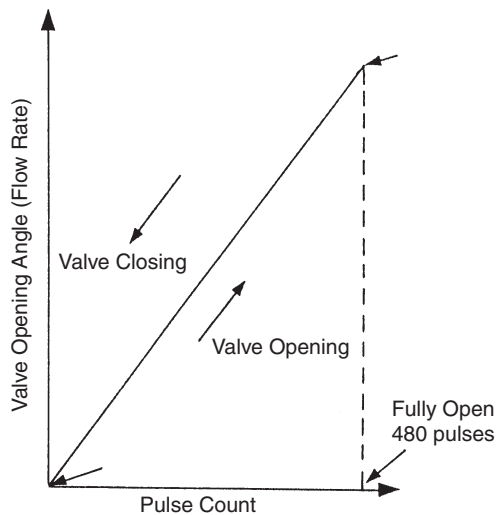

* When the power is switched ON, a 520 pulse valve opening signal is output to make sure the valve's position, so that it is definitely at point A. (The pulse signal is output for approximately 17 seconds.)

* When the valve operates smoothly, there is no sound from the LEV and no vibration occurs, but when the valve is locked, it emits a noise.

* Whether a sound is being emitted or not can be determined by holding a screwdriver, etc. against it, then placing your ear against the handle.

* If there is liquid refrigerant inside the LEV, the sound may become lower.

② LEV2

Pulse Signal Output and Valve Operation

Output (Phase) No.	Output State			
	1	2	3	4
φ1	ON	OFF	OFF	ON
φ2	ON	ON	OFF	OFF
φ3	OFF	ON	ON	OFF
φ4	OFF	OFF	ON	ON

Output pulses change in the following orders when the
 Valve is Closed 1 → 2 → 3 → 4 → 1
 Valve is Open 4 → 3 → 2 → 1 → 4

LEV Valve Closing and Valve Opening Operations

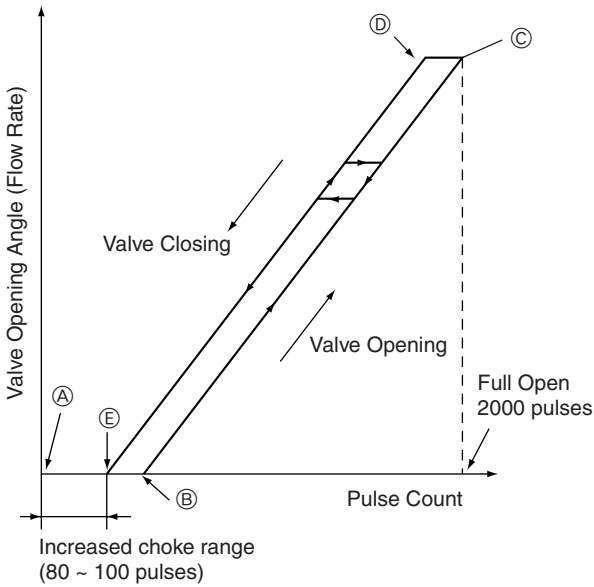

- *1. When the LEV opening does not change, all output phases are OFF.
- 2. When the output opens a phase and stays ON, the motor will not run smoothly and will clack and vibrate.
- 3. When the power source is turned on, a close valve signal (2200 pulse) is sent to confirm the valve position, ensuring a starting point of (A).
- 4. When the valve is operating smoothly, there will be no sound or vibrations from the LEV, when operation goes from point (E) to point (A), the valve locks and open phases create a considerable noise.
- 5. The noise emanates from the driver and can be easily discerned by placing a screwdriver against it and then placing your ear against the handle.

Caution

The specifications of the outdoor unit (outdoor LEV) and outdoor units (indoor LEV) differ. For this reason, there are cases where the treatment contents differ, so follow the treatment specified for the appropriate LEV as indicated in the right column.

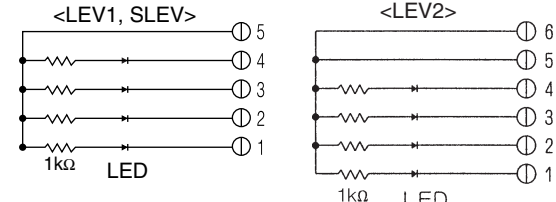
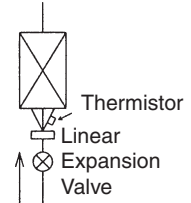
Failure Mode	Judgment Method	Treatment	Affected LEV
Microcomputer Driver Circuit Failure	<p>Disconnect the control board connector and connect the check LED as shown in the figure below.</p>  <p>When the base power supply is turned on, the indoor LEV outputs pulse signals for 10 seconds. If the LED does not light up, or lights up and remains on, the driver circuit is abnormal.</p>	In the case of driver circuit failure, replace the indoor unit's control board.	Indoor Outdoor
LEV mechanism is locked.	If the LEV is locked up, the drive motor turns with no load and a small clicking sound is generated. Generation of this sound when the LEV is fully closed or fully open is abnormal.	Replace the LEV.	Indoor Outdoor
The LEV motor coils have a disconnected wire or is shorted.	Measure the resistance between the coils (red - white, red - orange, brown - yellow, brown - blue) using a tester. They are normal if the resistance is within $150 \Omega \pm 10 \%$.	Replace the LEV coils.	Indoor
	Measure the resistance between the coils (gray - orange, gray - red, gray - yellow, gray - black) using a tester. They are normal if the resistance is within $46 \Omega \pm 3 \%$.	Replace the LEV coils.	Outdoor
Fully Closed Failure (valve leaks)	<p>If you are checking the indoor unit's LEV, operate the indoor unit in fan mode and at the same time operate other indoor units in the cooling mode, then check the piping temperatures (liquid pipe temperatures) of the indoor unit by the operation monitor through the outdoor unit controller board. When the fan is running, the linear expansion valve is fully closed, so if there is leakage, the temperature sensed by the thermistor (liquid pipe temperature sensor) will become low. If the temperature is considerably low compared to the remote control's intake temperature display, it can be judged that there is a fully closed failure. In the case of minimal leakage, it is not necessary to replace the LEV if there are no other effects.</p> 	If there is a large amount of leakage, replace the LEV.	Indoor
Faulty wire connections in the connector or faulty contact.	<ol style="list-style-type: none"> ① Check for pins not fully inserted on the connector and check the colors of the lead wires visually. ② Disconnect the control board's connector and conduct a continuity check using a tester. 	Check the continuity at the places where trouble is found.	Indoor Outdoor

Outdoor LEV (SLEV, LEV1) Coil Removal Procedure (configuration)

As shown in the figure, the outdoor LEV is made in such a way that the coils and the body can be separated.

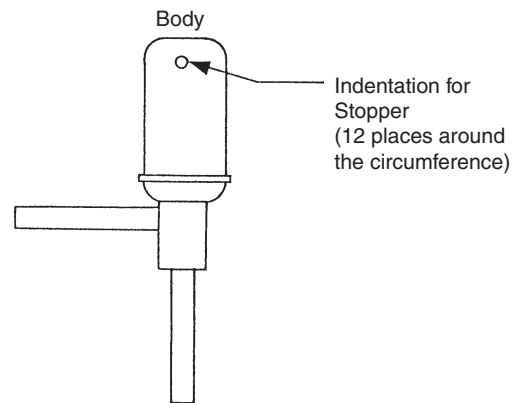
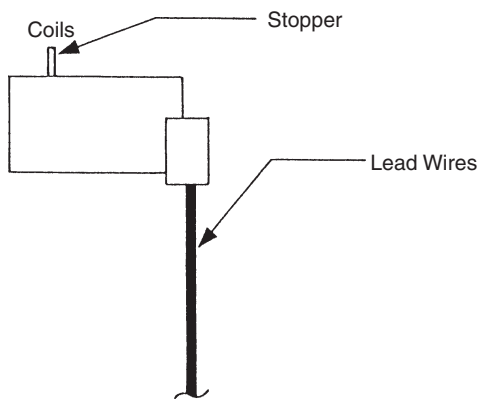

<Removing the Coils>

Fasten the body tightly at the bottom (Part A in the figure) so that the body will not move, then pull out the coils toward the top. If they catch on the stopper and are difficult to take out, turn the coils left and right until the stoppers are free from the stopper indentations, then pull the coils out.

If you take out the coils only without gripping the body, undue force will be applied to the piping and the pipe may be bent over, so be sure to fasten the body in such a way that it will not move.

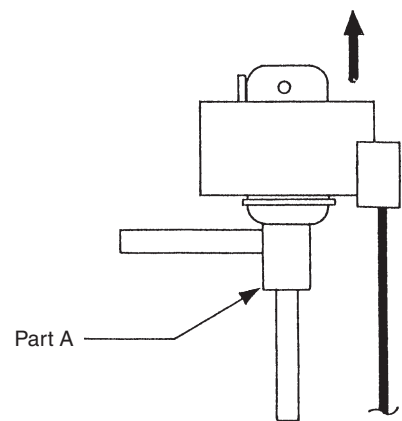

<Installing the Coils>

Fasten the body tightly at the bottom (Part A in the figure) so that the body will not move, then insert the coils from the top, inserting the coils' stopper securely in one of the indentations on the body. (There are four indentations for the stopper on the body around its circumference, and it doesn't matter which indentation is used. However, be careful not to apply undue force to the lead wires or twist them around inside the body.) If the coils are inserted without gripping the body, it may exert undue force on the piping, causing it to become bent, so be sure to hold the body firmly so that it won't move when installing the coils.

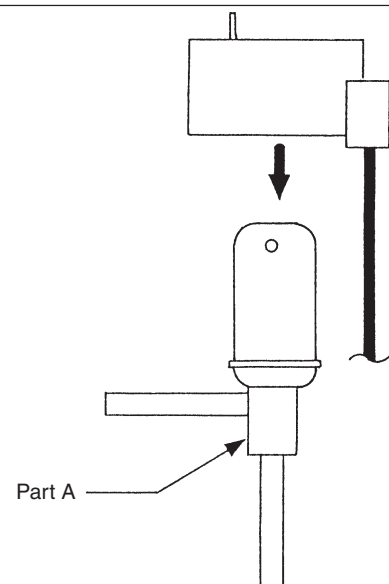

Power transistor

Measure resistances between each terminal of transistor module with tester, and use the results for troubleshooting. Specified resistance value is dependent on tester type to be used for resistance measurement, because diode transistor has non-linearity, thus difference of impedance and voltage in tester being influential. As the internal impedance of resistance range of analog tester equals to the center value of meter indication, the affect of internal impedance can be minimized if the tester having close center value of resistance range. Because internal voltage is normally 1.5 V, the tester to be used for troubleshooting of transistor module should satisfy the following conditions.

Internal voltage	1.5 V (Power source: one dry cell battery)
Central value of resistance range	10 ~ 40 Ω

The measured values for troubleshooting are shown in the table below.
(Use the minimum range for tester resistance range.)

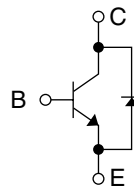
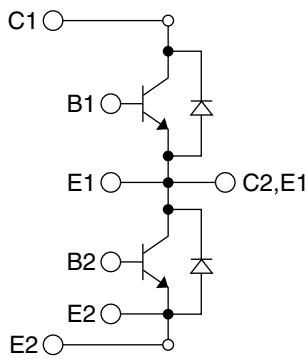

Transistor module has 6 circuits shown in the left.
(See figure below.)

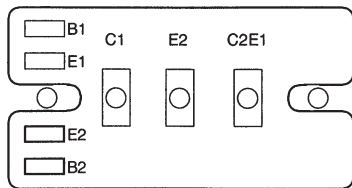

	Tester ⊕	C	B	E
Tester ⊖				
C			∞	∞
B		2 ~ 100 Ω		100 ~ 1500 Ω
E		2 ~ 100 Ω	100 ~ 1500 Ω	

Diode stack

Perform continuity check with tester. Judged as normal if the following characteristics are observed.
(Use the minimum range for tester resistance range.)

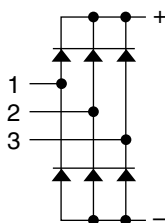
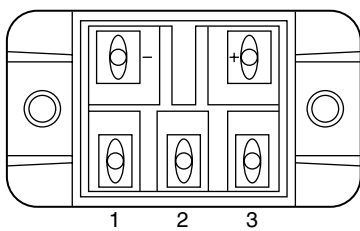

	Tester ⊕	+	-
Tester ⊖			
1		10 ~ 50 Ω	∞
2		10 ~ 50 Ω	∞
3		10 ~ 50 Ω	∞
Tester ⊖			
Tester ⊕		+	-
1		∞	10 ~ 50 Ω
2		∞	10 ~ 50 Ω
3		∞	10 ~ 50 Ω

Thyristor module (SCRM)

<Judgment Method> Measure the resistance between each of the SCRM pins and judge if there is a failure or not by the resulting values.

<Judgment Values 1> Check between G and K.
Use the smallest resistance range on the tester.
Judgment Value: $1.5 \Omega \sim 80 \Omega$

<Judgment Values 2> Check between AK1 and AK2.
Use the greatest resistance range on the tester.
Judgment Value: $60 \text{ k}\Omega \sim \infty \Omega$

<External View>

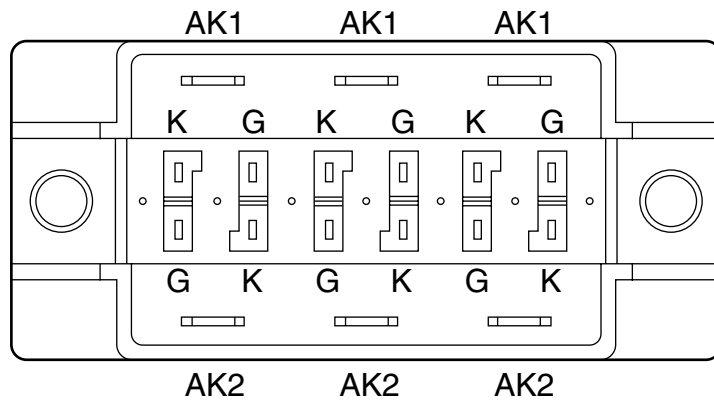

<Internal Circuit Diagrams>

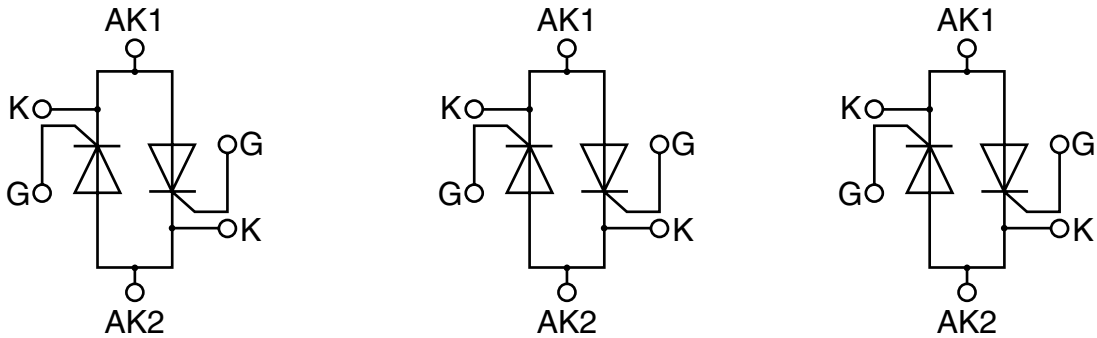

(2) Trouble and remedy of remote controller

	Symptom	Cause	Checking method & countermeasure
1	Despite pressing of remote controller switch, operation does not start with no electronic sound. (No powering signal ☉ appears.)	1) M-NET transmission power source is not supplied from outdoor unit. ① Main power source of outdoor unit is not connected. ② Slipping off of connector on outdoor unit circuit board. Main board: CNS1, CNVCC3 INV board : CNAC2, CNVCC1, CNL2 ③ Faulty power source circuit of outdoor unit. • Faulty INV board, • Blown fuse (F1 on INV board) • Broken diode stack • Broken resistor (R1) for rush current protection 2) Short circuit of transmission line. 3) Erroneous wiring of M-NET transmission line at outdoor unit. ① Transmission line disconnection or slipping off from terminal block. ② Erroneous connection of indoor/outdoor transmission line to TB7. 4) Slipping off of transmission wiring at remote controller. 5) Faulty remote controller.	a) Check transmission terminal block of remote controller for voltage. i) In case of 17 ~ 30 V → Faulty network remote controller ii) In case of less than 17 V → See "Transmission Power Circuit (30 V) Check Procedure". <div style="border: 1px solid black; padding: 5px; width: fit-content; margin-left: auto; margin-right: auto;"> The cause of 2) and 3) is displayed with LED monitor display LED for 7102 error. </div>
2	At about 10 seconds after turning remote controller operation switch ON, the display distinguishes and the operation stops.	1) Power source is not fed to indoor unit from transformer. ① Main power source of indoor unit is not turned on. ② Slipping off of connector (CND, CNT, CN3T) on indoor controller board. ③ Blown fuse on indoor controller board. ④ Faulty or disconnected transformer of indoor unit. ⑤ Faulty indoor controller board. 3) Faulty outdoor control circuit board or being out of control. As normal transmission is failed between indoor and outdoor units, outdoor unit model can not be recognized.	

Checking method & countermeasure

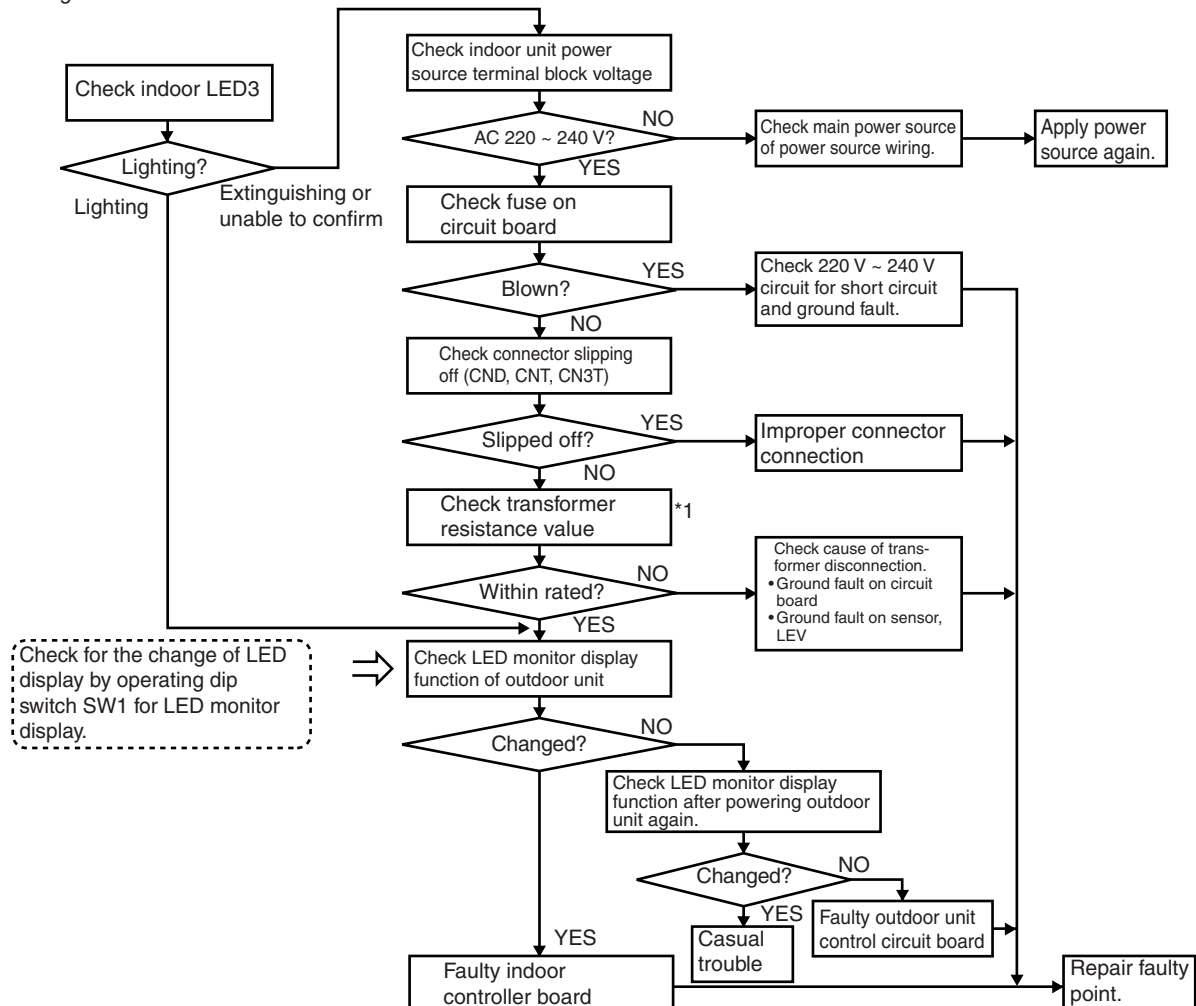

*1 Check the transformer in accordance with the "TROUBLE SHOOTING" in the indoor unit's service handbook.

Symptom	Cause
3 "HO" display on remote controller does not disappear and switch is ineffective.	<p>(Without using MELANS)</p> <ol style="list-style-type: none"> 1) Outdoor unit address is set to "000." 2) Erroneous address. <ol style="list-style-type: none"> ① Address setting miss of indoor unit to be coupled with remote controller. (Indoor unit address = Remote controller address - 100.) ② Address setting miss of remote controller. (Remote controller address = Indoor unit address + 100.) 3) Faulty wiring of transmission terminal block TB5 of indoor unit in the same group with remote controller. 4) Centralized control SW2-1 of outdoor unit is turned ON. 5) Setting to interlocking system from indoor unit (Switch 3-1 = OFF), while Fresh Master is intended to use by remote controller operation (indoor unit attribute). 6) Disconnection or faulty wiring of indoor unit transmission line. 7) Disconnection between indoor unit M-NET transmission line terminal block (TB5) and connector CN2M. 8) More than 2 sets of power supply connector (CN40) are inserted into centralized control transmission line of outdoor unit. 9) Faulty outdoor unit control circuit board. 10) Faulty indoor controller board. 11) Faulty remote controller. 12) The transmission booster is defective or the power supply has been cut-off. <hr/> <p>(Interlocking control with MELANS)</p> <ol style="list-style-type: none"> 13) No grouping registration with MELANS (Neglecting to set the relation between indoor unit and network remote controller). 14) Slipping off of centralized control transmission line (TB7) at outdoor unit. 15) At system connected with MELANS, power supply connector (CN40) is inserted to centralized control transmission line of outdoor unit. 16) The transmission booster is defective or the power supply has been cut-off.

Checking method & countermeasure

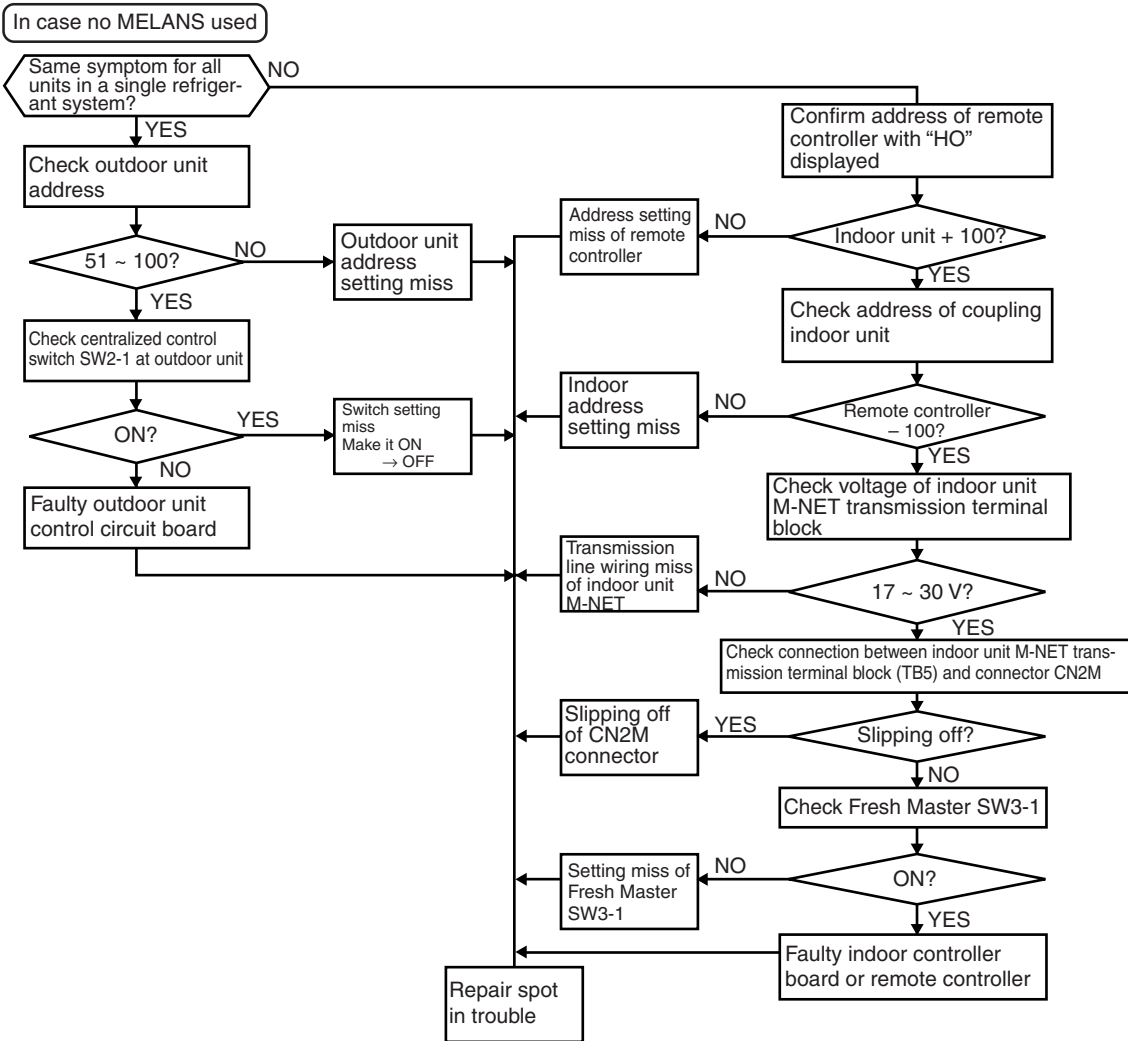

In case with MELANS used

When MELANS is used, "HO" display on the remote controller will disappear at the group registration of the indoor unit and local remote controller.
If "HO" does not disappear after the registration, check the items 12) ~ 14) in the Cause column.

	Symptom	Cause	Checking method & countermeasure
4	"88" appears on remote controller at the registration and access remote controller	<p>[Generates at registration and confirmation]</p> <ol style="list-style-type: none"> 1) Erroneous address of unit to be coupled. 2) Slipping off of transmission line of unit to be coupled (No connection). 3) Faulty circuit board of unit to be coupled. 4) Installation miss of transmission line. <hr/> <p>[Confirmation of different refrigerant system controller]</p> <ol style="list-style-type: none"> 5) Breaking of power source of outdoor unit to be confirmed. 6) Slipping off of centralized control transmission line (TB7) of outdoor unit. 7) Power supply connector (CN40) is not inserted into centralized control transmission line in grouping with different refrigerant system without using MELANS. 8) More than 2 sets of power supply connector are inserted into the centralized control transmission line of outdoor unit. 9) In the system connected with MELANS, power supply connector (CN40) is inserted into the centralized control transmission line of outdoor unit. 10) Short circuit of centralized control transmission line. 	<ol style="list-style-type: none"> a) Confirm the address of unit to be coupled. b) Check the connection of transmission line. c) Check the transmission terminal block voltage of unit to be coupled. <ol style="list-style-type: none"> i) Normal if voltage is DC 17 ~ 30 V ii) Check the item d) in case other than i). <hr/> <ol style="list-style-type: none"> d) Confirm the power source of outdoor unit to be coupled with the unit to be confirmed. e) Confirm that the centralized control transmission line (TB7) of outdoor unit is not slipped off. f) Confirm the voltage of centralized control transmission line. <ol style="list-style-type: none"> i) Normal in case of 10 V ~ 30 V ii) Check the items 7) ~ 10) left in case that other than i).

Transmission Power Circuit (30 V) Check Procedure

If “⊙” is not displayed by the remote control, investigate the points of the trouble by the following procedure and correct it.

No.	Check Item	Judgment	Response
1	Disconnect the transmission line from TB3 and check the TB3 voltage.	DC 24 ~ 30 V	Check the transmission line for the following, and correct any defects. Broken wire, short circuit, grounding, faulty contact.
		Except the above-mentioned	to No. 2
2	Check if the following connectors are disconnected in the outdoor unit's control box. MAIN Board: CNS1, CNVCC3 INV Board : CNVCC1, CNL2, CNR, CNAC2	Connector disconnected	Connect the connectors as shown on the electric wiring diagram plate.
		Except the above-mentioned	to No. 3
3	Disconnect the wires from CNVCC3 on the Main board and check the voltage between pins 1 and 3 on the wire side of the CNVCC3. Tester ⊕ 1 pin Tester ⊖ 3 pin	DC 24 ~ 30 V	Check the wiring between CNS1 and TB3 for the following, and correct any defects. Broken wire, short circuit, grounding, faulty contact. If there is no trouble, replace the Main board.
		Except the above-mentioned	to No. 4
4	Disconnect the wiring from CNVCC2 on the INV board and check the voltage between pins 1 and 3 of CNVCC2. Tester ⊕ 1 pin Tester ⊖ 3 pin	DC 24 ~ 30 V	Check the wiring between CNVCC2 and CNVCC3 for the following, and correct any defects. Broken wire, short circuit, grounding, faulty contact.
		Except the above-mentioned	to No. 5
5	Disconnect the wiring from CNL2 on the INV board, and check the resistance at both ends of choke coil L2.	0.5 ~ 2.5 Ω	to No. 6
		Except the above-mentioned	Replace choke coil L2.
6	Disconnect the wiring from CNR on the INV board, and check the resistance at both ends of R7.	19 ~ 25 Ω	to No. 7
		Except the above-mentioned	Replace R7.
7	Check the resistance at both ends of F01 on the INV board.	0 Ω	to No. 8
		Except the above-mentioned	Replace F01
8	Check the voltage between pins 1 and 3 of CNAC2 on the INV board.	AC 198 ~ 264 V	Replace the INV board.
		Except the above-mentioned	to No. 9
9	Check the voltage between L2 and N on power supply terminal block TB1.	AC 198 ~ 264 V	Check the wiring to CNAC2 for the following and correct any defects. Broken wire, faulty contact.
		Except the above-mentioned	Check the power supply wiring and base power supply, and correct any defects.

(3) Investigation of transmission wave shape/noise

Control is performed by exchanging signals between outdoor unit, indoor unit and remote controller by M-NET transmission. If noise should enter into the transmission line, the normal transmission will be hindered causing erroneous operation.

1) Symptom caused by the noise entered into transmission line

Cause	Erroneous operation	Error code
Noise entered into transmission line	Signal changes and is misjudged as the signal of other address.	6600
	Transmission wave shape changes to other signal due to noise.	6602
	Transmission wave shape changes due to noise, and can not be received normally thus providing no reply (ACK).	6607
	Transmission can not be made continuously due to the entry of fine noise.	6603
	Transmission can be made normally, but reply (ACK) or answer can not be issued normally due to noise.	6607 6608

2) Method to confirm wave shape

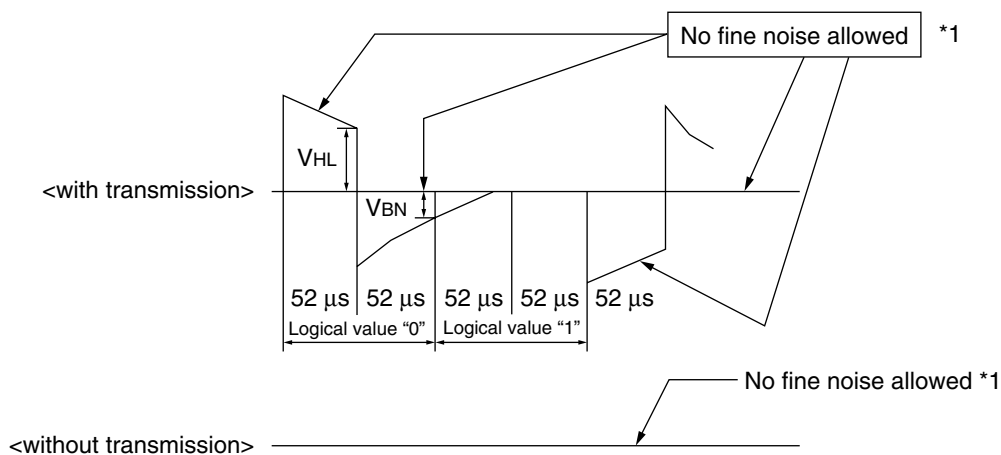

Check the wave shape of transmission line with an oscilloscope to confirm that the following conditions are being satisfied.

- ① The figure should be $104 \mu\text{s} / \text{bit} \pm 1 \%$.
- ② No finer wave shape (noise) than the transmission signal ($52 \mu\text{s} \pm 1 \%$) should be allowed. *1
- ③ The sectional voltage level of transmission signal should be as follows.

Logical value	Transmission line voltage level
0	VHL = 2.0 V or more
1	VBN = 1.3 V or less

*1 However, minute noise from the DC-DC converter or inverter operation may be picked up.

3) Checking and measures to be taken

(a) Measures against noise

Check the items below when noise can be confirmed on wave shape or the error code in the item 1) is generated.

Items to be checked		Measures to be taken
Checking for wiring method	① Wiring of transmission and power lines in crossing.	Isolate transmission line from power line (5 cm or more). Never put them in a same conduit.
	② Wiring of transmission line with that of other system in bundle.	Wire transmission line isolating from other transmission line. Wiring in bundle may cause erroneous operation like crosstalk.
	③ Use of shield wire for transmission line (for both indoor unit control and centralized control).	Use specified transmission wire. Type : Shield line CVVS/CPEVS Wire diameter: 1.25 mm ² or more
	④ Repeating of shield at the repeating of transmission line with indoor unit.	The transmission line is wired with 2-jumper system. Wire the shield with jumper system as same for transmission line. When the jumper wiring is not applied to the shield, the effect against noise will be reduced.
	⑤ Are the unit and transmission lines grounded as instructed in the INSTALLATION MANUAL?	Connect to ground as shown in the INSTALLATION MANUAL.
Check for earthing	⑥ Earthing of the shield of transmission line (for indoor unit control) to outdoor unit.	One point earthing should be made at outdoor unit. Without earthing, transmission signal may be changed as the noise on the transmission line has no way to escape.
	⑦ Arrangement for the shield of transmission line (for centralized control).	For the shield earth of the transmission line for centralized control, the effect of noise can be minimized if it is from one of the outdoor units in case of the group operation with different refrigerant systems, and from the upper rank controller in case the upper rank controller is used. However, the environment against noise such as the distance of transmission line, the number of connecting sets, the type of connecting controller, and the place of installation, is different for the wiring for centralized control. Therefore, the state of the work should be checked as follows. a) No earthing <ul style="list-style-type: none"> • Group operation with different refrigerant systems One point earthing at outdoor unit • Upper rank controller is used Earthing at the upper rank controller b) Error is generated even though one point earth is being connected. Earth shield at all outdoor units. Connect to ground as shown in the user's manual.

(b) When the wave height value of transmission wave shape is low, 6607 error is generated, or remote controller is under the state of "HO".

Items to be checked		Measures to be taken
	⑧ The farthest distance of transmission line is exceeding 200m.	Confirm that the farthest distance from outdoor unit to indoor unit/ remote controller is less than 200 m.
	⑨ The types of transmission lines are different.	Use the transmission wire specified. Type of transmission line : Shield wire CVVS/CPEVS Wire dia.of transmission line: 1.25 mm ² or more
	⑩ No transmission power (30 V) is being supplied to the indoor unit or the remote control.	Refer to "Transmission Power Supply (30 V) Circuit Check Procedure."
	⑪ Faulty indoor unit/remote controller.	Replace outdoor unit circuit board or remote controller.

4) Treatment of Inverter and Compressor Troubles

If the compressor does not work when error codes 4210, 4240, 4310 or 4340 are detected, determine the point of malfunction by following the steps in the **LED monitor display and countermeasures depending on the check code displayed**, then perform the procedures below.

No.	Check Item	Symptoms	Treatment
1	How many hours was the power kept on before operation?	① If it was kept on for 12 hours or longer as specified.	Go to [2].
		② It was kept on for less than the specified period.	Go to [2] after keeping the power on for the specified time.
2	When it is restarted, does the trouble reappear?	① The compressor stops and the same error code is displayed.	Perform the check of wiring shown in the explanation of each error code.
3	Run the outdoor unit with the wiring to the compressor disconnected. At this time, change SW1-1 on the INV board to ON. Note) The terminals of the 3 disconnected wires should be isolated from each other.	① The compressor stops and the same error code is displayed.	Check the transistor module is faulty. (Go to "Individual Parts Failure Judgment Methods.")
		② If the inverter's output voltage is output with good balance, *1.	Check the coil resistance and insulation resistance of the compressor, and if it is normal, run it again, and if the trouble occurs again, replace the compressor. [Go to "8) Compressor Replacement Procedure"] * Insulation resistance : 2 MΩ or more Coil resistance : 0.359 ~ 0.716 Ω
		③ If the balance in the inverter's output voltage is not good or if the inverter's output voltages are all 0 V (a digital tester cannot be used) *1.	Check the transistor module. Judge that the transistor module is faulty. (Go to "Individual Parts Failure Judgment Methods.") If the transistor module is normal, replace the INV board, then perform this item again with SW1-1 ON. If the problem is solved and you connect the compressor again, turn SW1-1 OFF again. Check the compressor's coil resistance and insulation resistance.

*1 [Cautions when measuring the voltage and current of the inverter's power circuit.]

Since the voltage and current on the inverter's power supply side and its output side do not have a sine waveform, the measurement values will differ depending on the measuring instrument and the circuit measured.

In particular, as the inverter's output voltage has a pulse waveform, the output frequency also changes, so differences in measurement values will be great depending on the measuring instrument.

- ① When checking if the inverter's output voltage is unbalanced or not (relative comparison of the voltages between each of the lines), if you are testing with a portable tester, be sure to use an analog tester.
Use a tester of a type which can be used to judge if the transistor module or diode module is faulty.
In particular, in cases where the inverter's output frequency is low, there are cases where the variations in measured voltage values between the different wires will be great when a portable digital tester is used, when in actuality they are virtually equal, and there is danger of judging that the inverter is faulty.
- ② It is recommended when checking the inverter's output voltage values (when measuring absolute values), that, if a measuring device for business frequencies is used, a rectified voltage meter (with a  symbol) be used.
Correct measurement values cannot be obtained with an ordinary portable tester. (either analog or digital)

5) Treatment of Fan Motor Related Troubles

Condition	Possible Cause	Check Method and Treatment																		
<p>① It won't run for 20 minutes or longer when the AK value is $\geq 10\%$. (When the MAIN board's SW1 is set as shown below, the AK value is displayed by the service LED.)</p> <ul style="list-style-type: none"> For Variable capacity unit SW1 = 0101001000 For Constant capacity unit SW4-2 = ON SW1 = 0101001000 <p>② The fan motor's vibration is great.</p>	1) The power supply voltage is abnormal.	<p>If there is an open phase condition before the breaker, after the breaker or at the power supply terminal blocks TB1 or TB1A, correct the connections.</p> <p>If the power supply voltage deviates from the specified range, connect the specified power supply.</p>																		
	2) Wiring is faulty.	<p>For the following wiring, 1 check the connections, 2 check the contact at the connectors, 3 check the tightening torque at parts where screws are tightened, 4 check the wiring polarity, 5 check for a broken wire and 6 check for grounding.</p> <table style="width: 100%; border-collapse: collapse;"> <thead> <tr> <th style="text-align: left; border-right: 1px dashed black;">Variable capacity unit</th> <th style="text-align: left;">Constant capacity unit</th> </tr> </thead> <tbody> <tr> <td style="border-right: 1px dashed black;">TB1 ~ NF ~ TB1A ~ CNTR1 ~ T01 ~ CNTR</td> <td>TB1 ~ F3 ~ T01 ~ CNTR</td> </tr> <tr> <td style="border-right: 1px dashed black;">TB1A ~ [F1, F2] ~ SCRM ~ CN04 ~ CNMF</td> <td>TB1 ~ F1, F2 ~ SCRM ~ CN04 ~ CNMF ~ MF</td> </tr> <tr> <td style="border-right: 1px dashed black;">CNFC1 ~ CNFC2</td> <td>CNFC1 ~ CNFC2</td> </tr> <tr> <td style="border-right: 1px dashed black;">CNU ~ SCRM</td> <td>CNU ~ SCRM</td> </tr> <tr> <td style="border-right: 1px dashed black;">CNV ~ SCRM</td> <td>CNV ~ SCRM</td> </tr> <tr> <td style="border-right: 1px dashed black;">CNW ~ SCRM</td> <td>CNW ~ SCRM</td> </tr> <tr> <td style="border-right: 1px dashed black;">SCRM ~ 52F ~ CNO5 ~ CNMF3 ~ MF3</td> <td></td> </tr> <tr> <td style="border-right: 1px dashed black;">SCRM ~ CNO4 ~ CNMF2 ~ MF2</td> <td></td> </tr> </tbody> </table> <p>* Check if the wiring polarity is as shown on the wiring diagram plate.</p>	Variable capacity unit	Constant capacity unit	TB1 ~ NF ~ TB1A ~ CNTR1 ~ T01 ~ CNTR	TB1 ~ F3 ~ T01 ~ CNTR	TB1A ~ [F1, F2] ~ SCRM ~ CN04 ~ CNMF	TB1 ~ F1, F2 ~ SCRM ~ CN04 ~ CNMF ~ MF	CNFC1 ~ CNFC2	CNFC1 ~ CNFC2	CNU ~ SCRM	CNU ~ SCRM	CNV ~ SCRM	CNV ~ SCRM	CNW ~ SCRM	CNW ~ SCRM	SCRM ~ 52F ~ CNO5 ~ CNMF3 ~ MF3		SCRM ~ CNO4 ~ CNMF2 ~ MF2	
	Variable capacity unit	Constant capacity unit																		
	TB1 ~ NF ~ TB1A ~ CNTR1 ~ T01 ~ CNTR	TB1 ~ F3 ~ T01 ~ CNTR																		
	TB1A ~ [F1, F2] ~ SCRM ~ CN04 ~ CNMF	TB1 ~ F1, F2 ~ SCRM ~ CN04 ~ CNMF ~ MF																		
	CNFC1 ~ CNFC2	CNFC1 ~ CNFC2																		
	CNU ~ SCRM	CNU ~ SCRM																		
CNV ~ SCRM	CNV ~ SCRM																			
CNW ~ SCRM	CNW ~ SCRM																			
SCRM ~ 52F ~ CNO5 ~ CNMF3 ~ MF3																				
SCRM ~ CNO4 ~ CNMF2 ~ MF2																				
3) The motor is faulty.	<p>Measure the resistance of the motor's coils: 20 ~ 60 Ω</p> <p>Measure the motor's insulation resistance with a megger: 10 MΩ (DC 500 V) or more</p>																			
4) A fuse (F1, F2, F3) is defective.	If a fuse is defective, replace it.																			
5) The transformer (T01) is defective.	Judge that T01 is faulty. Go to "Individual Parts Failure Judgment Methods."																			
6) The SCRM is defective.	Judge that the SCRM is faulty. Go to "Individual Parts Failure Judgment Methods."																			
7) The circuit board is faulty.	<p>If none of the items in 1) to 6) is applicable, and the trouble reappears even after the power is switched on again, replace the circuit board using the following procedure. (When replacing the circuit board, be sure to connect the connectors and ground wire, etc. securely.)</p> <p>① Replace the FANCON board only. If it recovers, the FANCON board is defective.</p> <p>② Replace the FANCON board and replace the MAIN board. If it recovers, the MAIN board is defective.</p> <p>③ If the trouble continues even after 1 and 2 above, then both boards are defective.</p> <p>(On the constant capacity unit, treat the MAIN board as the CONT board.)</p>																			

Caution

In the PUHY-400/500YMF-B, there are 2 fan motors, but as necessary, the fan motor on the left side when viewed from the front stops.

When there is a short intermediate period or the indoor unit has a low running capacity, the fan's rotational speed may fluctuate.

6) Troubleshooting at breaker tripping

Check items	Measures to be taken
① Check the breaker capacity.	The breaker's capacity should be proper.
② Check the a short circuit or grounding in the electrical system other than the inverter.	Correct any defects.
③ Check the resistance between terminals on the terminal block TB1 for power source. ① 0 ~ several ohms or improper megohm value	Check each part inside power circuit (resistance, megohm or the like). a) Diode stack Refer to "Troubleshooting of diode stack." b) Power transistor Refer to "Troubleshooting of power transistor." c) Rush current protection resistor d) Electromagnetic contactor e) DC reactor f) SCR * Refer to "Individual Parts Failure Judgement Methods." * For the constant capacity unit, check d) , f) only.
④ Checking by powering again.	
① Main power source circuit breaker tripping ② No display of remote controller	
⑤ Operational check by operating air conditioner	
① Normal operation without breaker tripping.	a) As there is a possibility of instantaneous short circuit generated, find the mark of the short circuit for repair. b) When a) is not applicable, the compressor may be faulty.
② Breaker tripping	The ground fault of inverter output/compressor can be supposed. Disconnect the wiring to the compressor and check the insulation resistance of the following parts with a megger. a) Compressor terminals. b) Inverter output.

7) Individual Parts Failure Judgment Methods.

Part Name		Judgment Method										
Diode Stack (DS)		Refer to “Judging Diode Stack Failure.”										
Transistor Module (TRM)		Refer to “Judging Transistor Module Failure.”										
Thyristor Module (SCRM)		Refer to “Judging Thyristor Module Failure.”										
Electromagnetic Contactor (52C1, 52C2, 52F)		Measure the resistance value at each terminal. <div style="text-align: center; margin: 10px 0;"> </div> <table border="1" style="margin-left: auto; margin-right: auto;"> <thead> <tr> <th>Check Location</th> <th>Judgment Value</th> </tr> </thead> <tbody> <tr> <td>A1-A2</td> <td>0.1 k ~ 1.3 kΩ</td> </tr> <tr> <td>1/L1-2/T1</td> <td>∞</td> </tr> <tr> <td>3/L2-4/T2</td> <td></td> </tr> <tr> <td>5/L3-6/T3</td> <td></td> </tr> </tbody> </table>	Check Location	Judgment Value	A1-A2	0.1 k ~ 1.3 kΩ	1/L1-2/T1	∞	3/L2-4/T2		5/L3-6/T3	
Check Location	Judgment Value											
A1-A2	0.1 k ~ 1.3 kΩ											
1/L1-2/T1	∞											
3/L2-4/T2												
5/L3-6/T3												
Rush Current Protection Resistor (R1, 5)		Measure the resistance between terminals: 4.5 k ~ 5.5 kΩ										
DC Reactor (DCL)		Measure the resistance between terminals: 1 Ω or lower										
		Measure the resistance between the terminals and the chassis: ∞										
Cooling Fan (MF1)		Measure the resistance between terminals: 0.1 k ~ 1.5 kΩ										
Transformer (T01)	PUHY-400/500 YMF-B	Measure the resistance between terminals on the primary side (CNTR1): 1.0 k ~ 2.5 kΩ Measure the resistance between terminals on the secondary side (CNTR): 20 ~ 60 Ω										
	PUHN-200/250 YMF-B	Measure the resistance between terminals on the primary side (F3): 5 ~ 60 Ω Measure the resistance between terminals on the secondary side (CNTR): 0 ~ 10 Ω										

[Caution at replacement of inverter parts]

- ① The transistor module and INV board should be replaced together at the same time.
 When the transistor module is damaged, the INV board may possibly be broken, and the use of the broken INV board damages the normal transistor module. Therefore, replace the transistor module and INV board together at the same time. However, if the INV board is damaged, judge that the transistor module is faulty, then judge whether replacement is necessary or not.
- ② Fully check wiring for incorrect and loose connection.
 The incorrect or loose connection of the power circuit part wiring like transistor module and diode module causes to damage the transistor module. Therefore, check the wiring fully. As the insufficient tightening of screws is difficult to find, tighten them together additionally after finishing other works. For the wiring of the base for transistor module, observe the wiring diagram below carefully as it has many terminals.
- ③ Coat the grease for radiation provided uniformly onto the radiation surface of transistor/diode modules.
 Coat the grease for radiation on the full surface in a thin layer, and fix the module securely with the screw for fastening. As the radiation grease attached on the wiring terminal causes poor contact, wipe it off if attached.

Model PUHY-400YMF-B, 500YMF-B

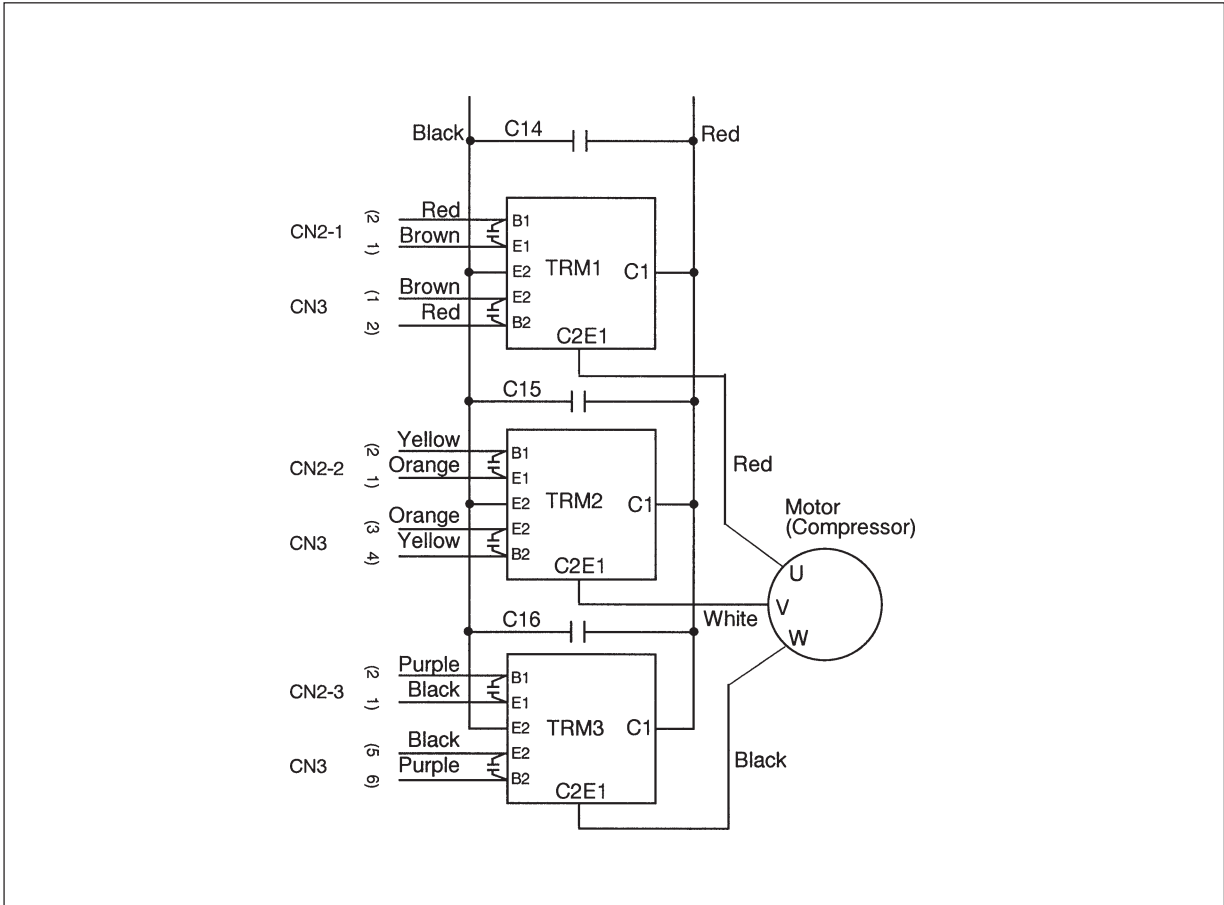

8) Compressor Replacement Procedure

When replacing a compressor, please proceed by the following procedure.

- When replacing the No. 1 compressor (variable capacity compressor), begin the replacement work after judging whether the trouble is a compressor breakdown or an inverter breakdown. If only one of the compressors is defective, run the unit for about 1 hour in the emergency operation mode, checking the following items and judging if the oil return circuit is defective or not before replacing the compressor.

(See [5]-[1] concerning the Emergency Operation Mode.)

- See the diagram at right concerning the temperature of each part.

<When Operating Normally>

- Part A Temperature = Part C temperature; furthermore, Compressor Part A temperature > ambient temperature + 20 deg.
- Part B Temperature = Part C temperature; furthermore, Part B temperature > ambient temperature + 20 deg.

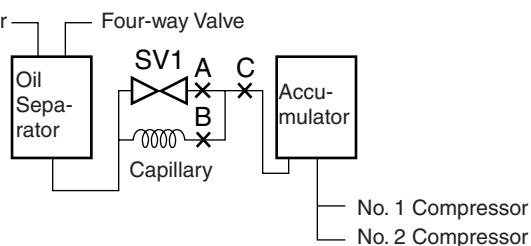

<When Operating Abnormally>

If ① is abnormal (outside the range),

Faulty oil return due to a faulty SV1 circuit (Replace the SV1 circuit).

If ② is abnormal (outside the range),

Faulty oil return due to capillary being clogged (Replace the capillary).

- Make sure the main power supply is turned off.

If the reason why the compressor is being replaced is faulty insulation resistance, if the insulation resistance is 1 MΩ or greater, it is possible that it has dropped due to the dormancy of the refrigerant to the compressor, so after turning on the power and heating for 12 hours or longer with a belt heater, turn off the power and check the insulation resistance again.

- Remove the fin guard, front panel and front panel of the divider panel on the right side facing the front.
- Drain out the refrigerant from the high pressure and low pressure check joints.
- Oil will be spilt from the oil exhaust pipe when it is removed. Be careful please not to spill a large amount of oil. Since oil absorbs moisture easily, do not leave the refrigerant circuit in the open state for long periods of time. Oil which has been drained out cannot be reused.
- When the oil has stopped draining from the refrigerant and exhaust oil outlets, remove fastening fitting 1 loosen the flare nuts on both ends of the oil equalization pipe and remove the oil equalization pipe.
- Close off the connection fittings for the oil equalization pipe of the compressors with simple caps, etc. to prevent oil from leaking out.
- Remove the compressor terminal cover, then disconnect the power cable.
Caution: When replacing both compressors, please take measures to prevent faulty wire connections when the compressors are reinstalled.
- Remove the discharge temperature thermistor and pipe fastening materials (a) ~ (e)*.
- Remove the belt heater.
- Heat up the soldered portions of the discharge piping, suction piping, volume control valve piping (All but model PUHY-400YMF-B) and process piping (All but model PUHY-400YMF-B) and disconnecting the piping.
- Remove the compressor mounting nuts and mounting fitting 2 (4 places on the No. 2 compressor only), then remove the compressor.
Caution: When removing the compressor, be careful not to let oil from inside the compressor overflow from the suction piping and process piping.
- Replace the compressor with a service unit.

	No. 1		No. 2	
	400-500	400	400	500
PUHY-400-500YMF-B	HHV92FAA-YJ	HH101YAA-J	ZHC165YDA-J	
PUHY-P400-500YMF-B	HEV92FA1-YJ	ZEC165YAA-J	ZEC165YAA-J	

Caution: Do not mistake the replacement compressor.

- (13) Solder the discharge piping, suction piping, volume control valve piping (All but model PUHY-400YMF-B) and process piping (All but model PUHY-400YMF-B).
- (14) Attach the oil equalization pipe to both compressors. In the case of the PUHY-P-YMF-B, replace the dryer with a new one. After replacing the dryer, do not leave the refrigerant circuit in the open state for a long period of time.
- (15) Shut the ball valves (both the fluid side and gas side) on the outdoor unit and apply nitrogen from the high and low pressure service check joint up to a pressure of A, checking to make sure there is no leakage.

$$*A = \begin{cases} 30 \text{ kg/cm}^2\text{G (2.94 MPa)} & \text{----- PUHY-400-500 YMF-B} \\ 30.4 \text{ kg/cm}^2\text{G (2.98 MPa)} & \text{----- PUHY-P400-500 YMF-B} \end{cases}$$

- (16) Discharge the nitrogen gas.
- (17) Open the ball valves (both the liquid side and gas side) on the outdoor unit and apply a vacuum.
- (18) Install the belt heater.
Caution: Do not mistake the belt heaters for the 2 compressors (particularly the PUHY-400 YMF-B).
- (19) Install the pipe fasteners (a) ~ (d) in their original places.
Caution: If these fasteners are not mounted as they were originally, it could cause the pipe to crack during operation, so install them securely.
- (20) Mount the discharge temperature thermistor and attach the insulating cover.
- (21) Connect the power cable to the compressor's terminals.
Caution: Be careful not to mistake the three phases. If the wires are connected wrong, it could damage the compressor.
- (22) When applying the vacuum is completed, charge the unit with the amount of refrigerant it is charged with at the factory, and with the supplementary amount it is charged with when it is installed.
- (23) After reconfirming the phase of the power cable wires at the compressors terminals, carry out an insulation resistance check, then install the terminal cover and turn on the main power supply, checking if current is flowing to the belt heater.
Caution: When the ambient temperature is 5°C or lower, if you do not spend 4 hours with the power on to the heater, the unit will not function even when the remote control is operated.
- (24) Make sure the liquid side and gas side ball valves are opened.
- (25) Run all the indoor units and make sure they are operating normally.

Parts around the oil equalization pipe.

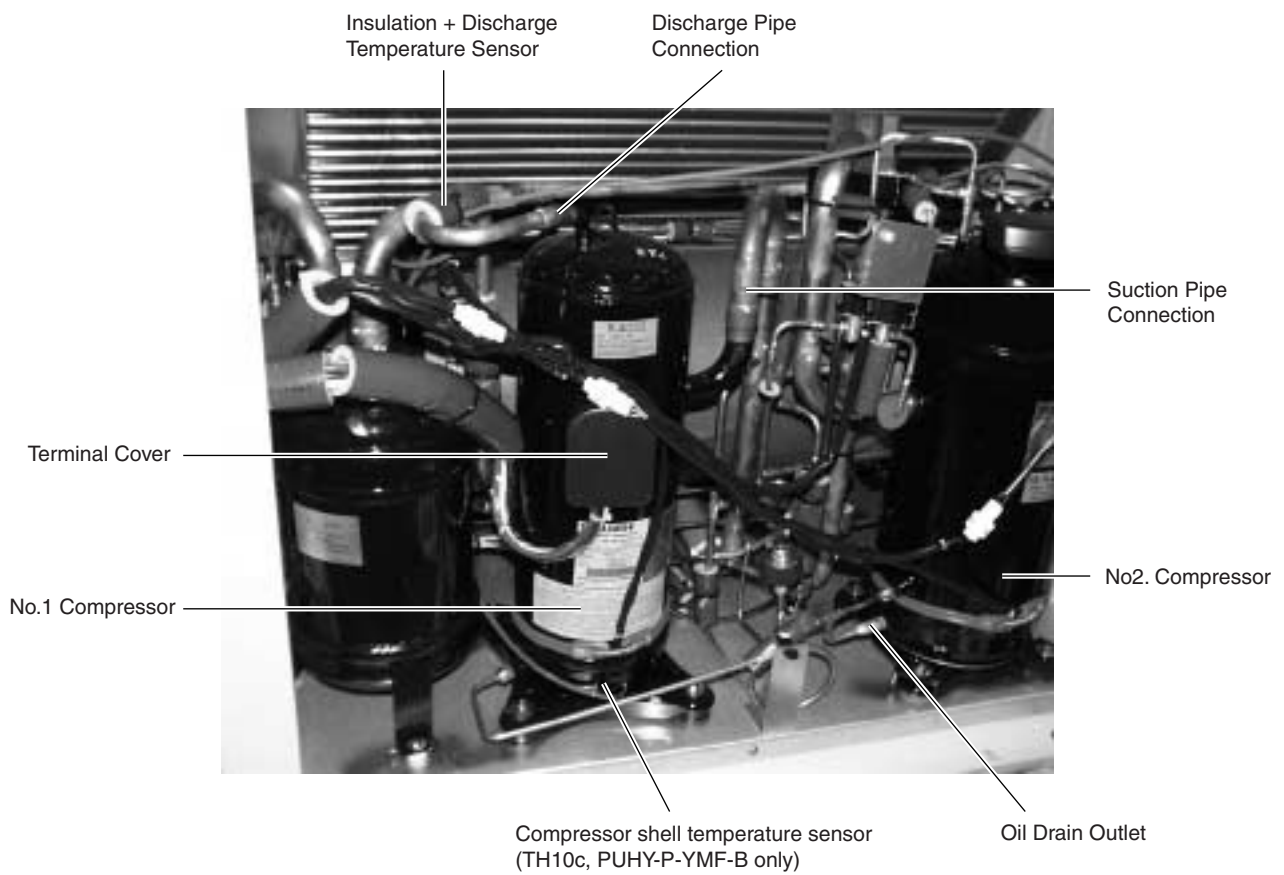
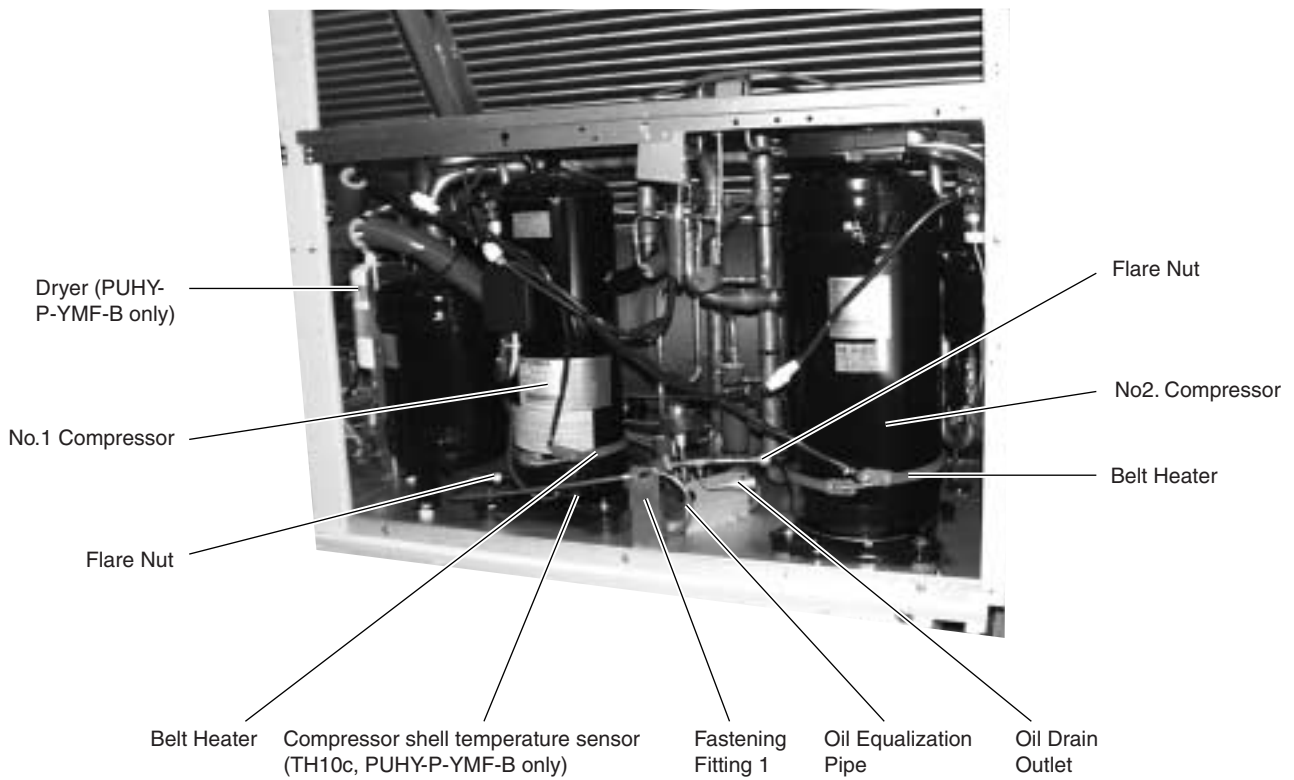

Around the No.2 Compressor (PUHY-400YMF-B)

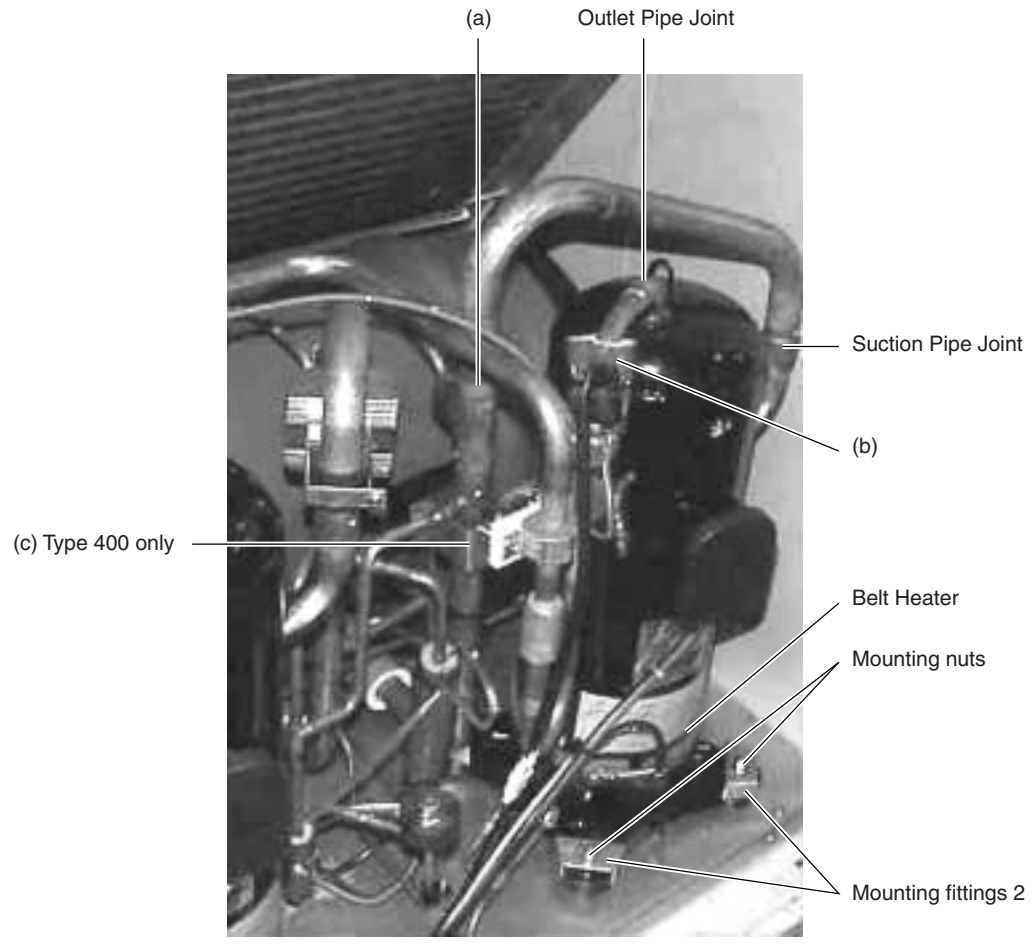

Around the No. 2 Compressor (All but model PUHY-400 YMF-B)

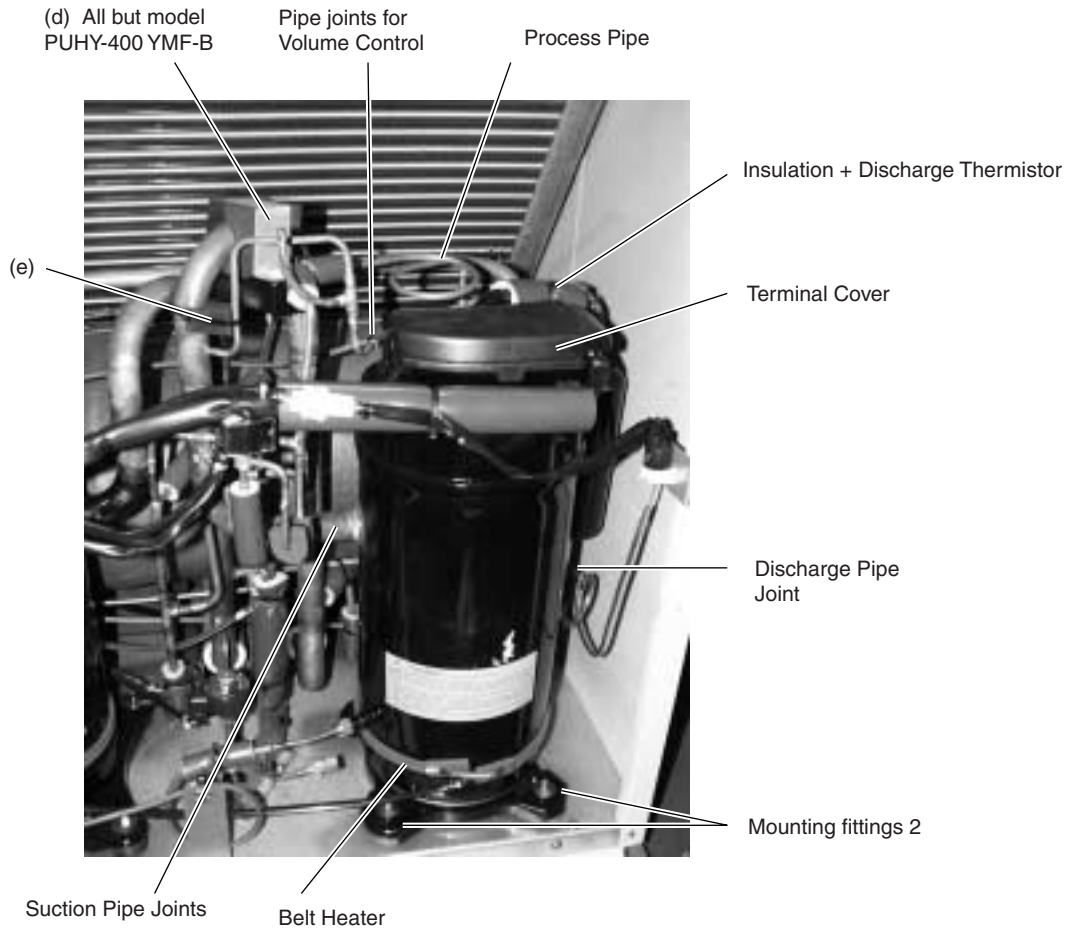

(4) Constant Capacity Unit

Observe the following notes when changing the compressor

(1) Make sure the main power supply is turned off.

If the reason for the compressor replacement is faulty insulation resistance, if the insulation resistance (Mega-check) is 1 MΩ or greater, it is possible that it has dropped due to the dormancy of the refrigerant to the compressor, so after turning on the power for 12 hours with a belt heater heating, turn off the power and check the insulation resistance again.

(2) Remove the fin guard, front panel, and front panel of the divider panel.

(3) Drain out the refrigerant from the high pressure and low pressure check joints.

(4) Remove the compressor terminal cover, then disconnect the power cable.

(5) Disconnect the discharge temperature sensor.

(6) Disconnect the crankcase heater.

(7) Heat up the soldered portions of the discharge piping, suction piping, and process piping and disconnect the piping.

(8) Remove the compressor mounting nuts, then remove the compressor.

Caution: When removing the compressor, be careful not to let oil from inside the compressor overflow from the suction piping and process piping.

(9) Replace the compressor (service parts).

Caution: Do not use a compressor for another model.

The refrigerator oil is different for each model, so be sure to check!

	Type 200	Type250
PUHN-YMF-B	ZH133YDA	ZH165YDA
PUHN-PYMF-B	ZEC133YAA	ZEC165YAA

(10) Braze the discharge piping, suction piping, volume control valve piping and process piping.

(11) Shut the ball valves (liquid, gas, and oil balance pipe) on the outdoor unit and apply nitrogen from the high and low pressure service check joint, up to a pressure of A, checking to make sure there is no leakage.

$$*A = \begin{cases} 30 \text{ kg/cm}^2\text{G (2.94 MPa)} & \text{----- PUHN-YMF-B} \\ 30.4 \text{ kg/cm}^2\text{G (2.98 MPa)} & \text{----- PUHN-P-YMF-B} \end{cases}$$

(12) Discharge the nitrogen gas.

(13) Open the ball valves (liquid, gas, and oil balance pipe) on the outdoor unit and apply a vacuum.

(14) Install the crankcase heater

(15) Mount the discharge temperature sensor and attach the insulating cover.

(16) Connect the power cable to the compressor's terminals.

Caution: Be careful not to misalign the three phases. If the wires are connected wrong, it could damage the compressor.

(17) When applying the vacuum is completed, charge the unit with the amount of refrigerant it is charged with at the factory, and with the supplementary amount it is charged with upon installation.

(18) After reconfirming the phase of the power cable wires at the compressors' terminals, carry out an insulation resistance check, then install the terminal cover and turn on the main power supply, checking if current is flowing to the crankcase heater.

Caution: When the ambient temperature is 5°C or lower, if you do not spend 4 hours with the power on to the heater, the unit will not function even when the remote controller is operated.

(19) Make sure the ball valves of liquid, gas, and oil balance pipe are opened.

(20) Run all the indoor units and make sure they are operating normally.

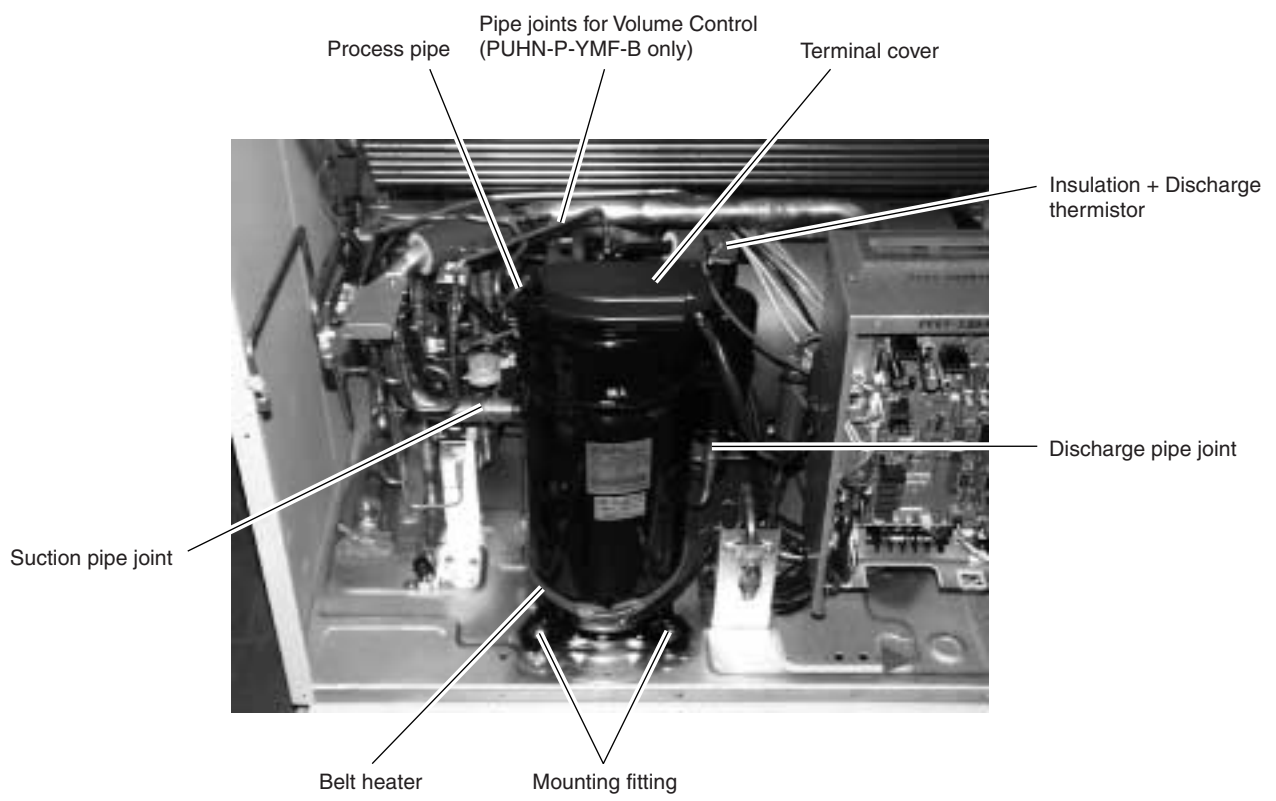

Check Code List

Check Code	Check Content		Inverter error detail *1	
0403	Serial transmission abnormality		—	
0900	Trial operation		—	
1102	Discharge temperature abnormality		—	
1111	Low pressure saturation temperature sensor abnormality (TH2)		—	
1112	Low pressure saturation	Liquid level sensing temperature sensor abnormality (TH4)	—	
1113	temperature abnormality	Liquid level sensing temperature sensor abnormality (TH3)	—	
1301	Low pressure abnormality		—	
1302	High pressure abnormality		—	
1500	Overcharged refrigerant abnormality		—	
1501	Low refrigerant abnormality		—	
1505	Suction pressure abnormality		—	
1559	Oil balance circuit abnormality		—	
2500	Leakage (water) abnormality		—	
2502	Drain pump abnormality		—	
2503	Drain sensor abnormality		—	
4103	Reverse phase abnormality		—	
4106	Constant capacity unit power off abnormality		—	
4108	Overcurrent protection (51C2)		—	
4115	Power supply sync signal abnormality		—	
4116	Fan speed abnormality (motor abnormality)		—	
4200	VDC sensor/circuit abnormality		—	
4210	Breaking of overcurrent		—	
4220	Bus voltage abnormality	S/W detect	No.5	
		H/W detect	No.10	
4230	Radiator panel overheat protection		—	
4240	Overcurrent protection		—	
4260	Cooling fan abnormality		—	
5101	Thermal sensor abnormality	Air inlet (TH21: IC)	—	
		Discharge (TH1: OC)	—	
5102		Liquid pipe (TH22: IC)	—	
		Low pressure saturation (TH2: OC)	—	
5103		Gas pipe (TH23: IC)	—	
		Accumulator liquid level (TH3)	—	
5104		Accumulator liquid level (TH4)	—	
5105		Liquid pipe (TH5)	—	
5106		Ambient temperature (TH6)	—	
5107		SC coil outlet (TH7)	—	
5108		SC coil bypass outlet (TH8)	—	
5109		SC coil bypass inlet (TH9a), CS circuit (TH9b)	—	
5110		Radiator panel	—	
5112		Heat exchanger (a) Gas pipe temperature (TH10a) abnormality	—	
5113		Heat exchanger (b) Gas pipe temperature (TH10b) abnormality	—	
		Distribution pipe temperature (TH10b) (Constant capacity unit) abnormality	—	
5114		Compressor shell temperature (TH10c)	—	
5201		Pressure sensor abnormality		—
5301		IDC sensor/circuit abnormality		—
6600		Multiple address abnormality		—
6602		Transmission processor hardware abnormality		—
6603		Transmission circuit bus-busy abnormality		—

*1: Refer to [3] LED Monitor Display

Check Code	Check Content	Inverter error detail *1
6607	No ACK abnormality	—
6606	Communications with transmission processor abnormality	—
6608	No response abnormality	—
7100	Total capacity abnormality	—
7101	Capacity code abnormality	—
7102	Connected unit count over	—
7105	Address setting abnormality	—
7106	Characteristics setting abnormality	—
7111	Remote control sensor abnormality	—
7130	Different indoor model connect abnormality	—

Preliminary Abnormality code list

Preliminary Abnormality code	Preliminary Abnormality Content	Inverter error detail *1	
1202	Preliminary discharge temperature abnormality or preliminary discharge thermal sensor abnormality (TH1)	—	
1204	Preliminary heat exchanger gas temperature sensor abnormality (variable capacity unit (TH10a, TH10b), constant capacity unit (TH10a))	—	
1205	Preliminary liquid pipe temperature sensor abnormality (TH5)	—	
1211	Preliminary low pressure saturation abnormality or preliminary low pressure saturation sensor abnormality (TH2)	—	
1212	Preliminary low pressure saturation abnormality or preliminary liquid level sensor upper thermal sensor abnormality (TH4)	—	
1213	Preliminary low pressure saturation abnormality or preliminary liquid level sensor lower thermal sensor abnormality (TH3)	—	
1214	Preliminary THHS sensor/circuit abnormality	—	
1216	Preliminary sub-cool coil outlet thermal sensor abnormality (TH7)	—	
1217	Preliminary sub-cool coil bypass outlet thermal sensor abnormality (TH8)	—	
1218	Preliminary sub-cool coil bypass inlet thermal sensor abnormality (TH9a)	—	
1219	Preliminary CS circuit inlet thermal sensor abnormality (TH9b)	—	
1221	Preliminary ambient temperature thermal sensor abnormality (TH6)	—	
1259	Preliminary distribution pipe temperature sensor abnormality	—	
1402	Preliminary high pressure abnormality or preliminary pressure sensor abnormality	—	
1600	Preliminary overcharged refrigerant abnormality	—	
1601	Preliminary lacked refrigerant abnormality	—	
1605	Preliminary suction pressure abnormality	—	
1607	CS circuit block abnormality	—	
1608	Control valve abnormality	—	
1659	Oil balance circuit abnormality	—	
4158	Preliminary overcurrent protection (51C2)	—	
4300	Preliminary IDC sensor/circuit abnormality	No.6	
	Preliminary VDC sensor/circuit abnormality	No.7	
	Preliminary serial transmission abnormality	No.9	
4310	Preliminary overcurrent breaking abnormality	—	
4320	Preliminary bus voltage abnormality	S/W detect	No.5
		H/W detect	No.10
4330	Preliminary heat sink overheating abnormality	—	
4340	Preliminary overload protection	—	
4360	Preliminary cooling fan abnormality	—	

*1: Refer to [3] LED Monitor Display

[2] LED monitor display and Countermeasures Depending on the Check Code Displayed

(1) Mechanical

Checking code	Meaning, detecting method	Cause	Checking method & Countermeasure
0403 Serial transmission abnormality (Variable capacity unit)	If serial transmission cannot be established between the MAIN and INV boards.	1) Wiring is defective.	Check 1, the connections, 2, contact at the connectors and 3, for broken wires in the following wiring. CNRS2 - CNRS3 CNAC2 - TB1A
		2) Switches are set wrong on the INV board.	SW1-4 on the INV board should be OFF.
		3) A fuse (F01) on the INV board is defective.	If the fuse is melted, (if the resistance between the both ends of fuse is ∞), replace the fuse.
		4) The circuit board is defective.	If none of the items in 1) to 3) is applicable, and if the trouble reappears even after the power is switched on again, replace the circuit board by the following procedure (when replacing the circuit board, be sure to connect all the connectors, ground wires, etc. securely). ① If serial transmission is restored after the INV board only is replaced, then the INV board is defective. ② If serial transmission is not restored, reinstall the INV board and replace the MAIN board. If serial transmission is restored, the MAIN board is defective. ③ If serial transmission is not restored by ① and ② above, replace both boards.
1102 Discharge temperature abnormality (Outdoor unit)	<p>① When an operating outlet temperature of 140°C or more is detected (first detection), the outdoor unit will pause and the restart prevention mode will be activated for 3 minutes after which the unit will be restarted.</p> <p>② If the outdoor unit is restarted within 30 minutes of stopping temperature of 140°C or more is detected again (second detection), the outdoor unit will pause again and the restart prevention mode will be activated for 3 minutes after which the unit will be restarted.</p> <p>③ If 140°C or more is detected again within 30 minutes of the outdoor unit being stopped (third detection), an error stop is performed and "1102" is displayed.</p> <p>④ If 140°C or more is detected after 30 minutes has passed since the outdoor unit was stopped, it is treated as the first detection and ① above is repeated.</p> <p>⑤ The unit is in an error stop delay period for 30 minutes after the outdoor unit has been stopped, during which the error stop delay LED is displayed.</p>	1) Gas leakage, insufficient gas.	Refer to Refrigerant amount check .
		2) Overload operation.	Check the operating condition of the indoor unit and operating status.
		3) Improper operation of indoor unit LEV.	Perform actual cooling or heating and check operating condition (Check operation of LEV). Cooling: Indoor LEV LEV1 Heating: Indoor LEV
		4) Improper operation of outdoor LEV1.	
		5) Defective ball valve operation.	See Trouble check of LEV and solenoid valve . Check if ball valve is completely open.
		6) Locking of outdoor unit fan, defective motor, all heating due to improper operation of fan micro-computer. (3) to 6) Rise in outlet temperature due to drawing in of low pressure.)	* Inspect outdoor unit fan. * Refer to Trouble check of outdoor fan .
		7) Gas leakage between high and low pressure. (4-way valve defective, compressor defective, solenoid valves 1, 4 defective.)	Confirm operating status by performing both heating and cooling operations.
		8) Defective operation of solenoid valve SV4. (The SV4 bypass valve cannot control rise in temperature of outlet temperature.)	Refer to Trouble check of solenoid valve .
		9) Defective thermistor. (TH11, 12)	Check resistance of thermistor.
		10) Defective thermistor input circuit on main circuit board.	Use LED monitor to check the temperature taken by the sensor and whether or not there are any problems with connector connections.

Checking code		Meaning, detecting method	Cause	Checking method & Countermeasure
1111	Low pressure saturation temperature sensor abnormality (TH2) (Variable capacity unit)	<p>① If saturation temperature sensor TH2 or liquid level sensors TH3, TH4 detect a temperature of -40°C or less (1st detection), the outdoor unit is temporarily stopped and it enters the re-start prohibit mode for 3 minutes after which it is started.</p> <p>② If -40°C or more is detected again within 30 minutes of the stopping of the outdoor unit, (2nd detection), the outdoor unit is temporarily stopped again and it enters the re-start prohibit mode for 3 minutes after which it is started.</p>	1) Gas leak, insufficient gas.	Refer to Refrigerant amount check .
			2) Light load operation.	Check operating conditions and status of indoor unit and outdoor unit.
1112	Liquid level sensing temperature sensor abnormality (TH4) (Outdoor unit)	<p>③ If -40°C or more is detected again within 30 minutes of the outdoor unit being stopped (3rd detection), an error stop is performed and either "1111", "1112" or "1113" is displayed.</p> <p>④ If -40°C or more is detected after 30 minutes has passed since the outdoor unit was stopped, it is treated as the first detection and ① above is repeated.</p> <p>⑤ The unit is in an error stop delay period for 30 minutes after the outdoor unit has been stopped, during which time the error stop delay LED is displayed.</p>	3) Defective operation of indoor operation LEV. 4) Defective operation of outdoor operation LEV1 → Cooling 5) Defective operation of solenoid valve SV5b → Heating. Defective operation of 4-way switching valve 21S4b → Heating.	Perform actual operation of cooling and heating and check operating status. (Check operation of LEV) Cooling - indoor unit LEV, LEV1 Heating - indoor unit LEV SV5b (whether or not it is closed) 21S4b (whether or not it is closed) Refer to Trouble check of LEV and solenoid valve .
			6) Defective operation of ball valve.	Check if ball valve is fully open.
1113	Liquid level detection temperature sensor abnormality (TH3) (Outdoor unit)	<p>Note)</p> <p>1: Low Pressure Saturation Temperature error is not detected for 3 minutes after the start of compressor operation, during defrosting and for 3 minutes after recovering from defrosting.</p> <p>2: "1111", "1112", or "1113" are also displayed if TH2 ~ TH4 sensors are shorted or open within 10 minutes before or after the compressor starts operating.</p>	7) Short cycle of indoor unit. 8) Plugged filter of indoor unit. 9) Reduced fan flow due to dirty fan. 10) Dirty indoor heat exchanger. 11) Defective indoor fan block, motor, Note: For 7) to 11) there is a drop in low pressure due to a drop in evaporation performance during cooling.	Inspect indoor unit and repair necessary areas.
			12) Short cycle of outdoor unit. 13) Dirty heat exchanger of outdoor unit.	Inspect indoor unit and repair necessary areas.
			14) Defective indoor fan block, motor, defective fan microcomputer operation, defective operation of solenoid contactor 52F. Note: For 12) to 14) there is a drop in low pressure due to a drop in evaporation performance during heating.	Inspect outdoor unit fan. Refer to Trouble check of outdoor unit fan .
			15) Defective operation of solenoid valve SV22/32. (Full load operation during unload.) All but model PUHY-400YMF-B.	Refer to Trouble check of solenoid valve .
			16) Defective operation of solenoid valve contactor 52C2. (No. 2 compressor operating when it should be stopped)	
			17) Defective operation of solenoid valve SV4. (Cannot control low pressure drop with bypass valve (SV4))	
			18) Defective thermistor. (TH2 ~ TH6)	Check resistance of thermistor.
			19) Defective pressure sensor.	Refer to Trouble check of pressure sensor .
			20) Defective input circuit for thermistor and pressure sensor on main circuit board.	Check whether or not sensor pick-up heat and pressure using the LED monitor. Also check if the connector connections are good.
			21) Defective mounting of thermistor (TH2 ~ TH6).	

Checking code	Meaning, detecting method	Cause	Checking method & Countermeasure
1301	Low pressure abnormality (Outdoor unit) When press. sensor detects 1 kg/cm ² G (0.098 MPa) or less just before starting of operation, error stop is observed with code No. "1301" displayed.	1) Fall in internal press. caused by gas leak. 2) Press. sensor trouble. 3) Film breakage. 4) Coming off of pin in connector portion, poor contact. 5) Broken wire. 6) Press. sensor input circuit trouble on control circuit board.	Refer to Trouble check of pressure sensor .
1302	High pressure abnormality 1 (Outdoor unit) ① If pressure sensor detects an error of 28 kg/cm ² G (2.74 MPa) (1st detection), the outdoor unit is temporarily stopped and it enters the re-start prohibit mode for 3 minutes after which it is started. ② If 28 kg/cm ² G (2.74 MPa) is detected again within 30 minutes of the stopping of the outdoor unit, (2nd detection), the outdoor unit is temporarily stopped again and it enters the re-start prohibit mode for 3 minutes after which it is started. ③ If 30 kg/cm ² G (2.94 MPa) or more is detected again within 30 minutes of the outdoor unit being stopped (3rd detection), an error stop is performed and "1302" is displayed. ④ If 28 kg/cm ² G (2.74 MPa) or more is detected after 30 minutes has passed since the outdoor unit was stopped, it is treated as the first detection and ① above is repeated. ⑤ The unit is in an error stop delay period for 30 minutes after the outdoor unit has been stopped, during which time the error stop delay LED is displayed. ⑥ The rapid error stop is activated if the pressure make-or-break switch (30 ⁺⁰ _{-1.5} kg/cm ² G) (2.94 ⁺⁰ _{-1.5} MPa) operates separately from the pressure sensor.	1) Defective operation of indoor unit LEV. 2) Defective operation of solenoid valve 21S4b, SV5B → Cooling. 3) Defective ball joint operation. 4) Short cycle of indoor unit. 5) Plugged filter of indoor unit. 6) Reduced fan flow due to dirty fan. 7) Dirty indoor heat exchanger. 8) Defective indoor fan block, motor, Note: For 4) to 8) there is a drop in condensor performance due to a rise in high pressure during heating. 9) Short cycle of outdoor unit. 10) Dirty outdoor unit heat exchanger. 11) Defective outdoor fan block, motor, defective fan microcomputer operation, defective Note: 9) to 11) is drop in condensor performance during cooling due to rise in high pressure. 12) Defective operation of solenoid valve SV22/32. (Full load operation during unload. 500 YBM only.) 13) Defective operation of solenoid valve contactor 52C2 (No. 2 compressor operating when it should be stopped). 14) Defective operation of solenoid valve SV1, 4. (Cannot control high pressure rise with bypass valve (SV1,4).) 15) Defective thermistor. (TH2, TH5, TH6) 16) Defective pressure sensor. 17) Defective input circuit for thermistor and pressure sensor on main circuit board. 18) Defective mounting of thermistor. (TH2, TH5, TH6) 19) Missing or disconnected pressure switch connector (63H).	Perform actual operation of cooling and heating and check operating status. Cooling - SV5B, 21S4b Heating - indoor unit LEV Refer to Trouble check of LEV and Solenoid valve . Check if ball joint is fully open. Check indoor unit and take measures to trouble. Inspect outdoor unit and repair necessary areas. Inspect outdoor fan. Refer to Trouble check of outdoor unit fan . Refer to Trouble check of Solenoid valve . Check resistance of thermistor. Refer to section on determining if pressure sensor has failed. Check whether or not sensor pick-up heat and pressure using the LED monitor. Check whether or not sensor pick-up heat and pressure using the LED monitor. Check whether or not sensor pick-up heat and pressure using the LED monitor.
	High pressure abnormality 2 (Variable capacity unit) When press. sensor detects 1 kg/cm ² G (0.098 MPa) or less just before starting of operation, error stop is observed with code No. "1302" displayed.	1) Fall in internal press. caused by gas leak. 2) Press. sensor trouble. 3) Film breakage. 4) Coming off of pin in connector portion, poor contact. 5) Broken wire. 6) Press. sensor input circuit trouble on control circuit board.	Refer to Trouble check of pressure sensor .

Checking code		Meaning, detecting method	Cause	Checking method & Countermeasure
1500	Overcharged refrigerant abnormality (Outdoor unit)	<p>A error is detected in the outlet temperature super heat (TH11, 12-Tc) and in the liquid level in the accumulator as indicated below.</p> <p>① If the liquid level in the accumulator AL = 2 (over level) develops during operation, (1st detection), the outdoor unit is temporarily stopped and it enters the re-start prohibit mode for 3 minutes after which it is started.</p> <p>② If liquid level in the accumulator AL = 2 (over level) is detected again within 30 minutes of the stopping of the outdoor unit, (2nd detection), the outdoor unit is an error stop is performed and "1500" is displayed.</p> <p>③ If liquid level in the accumulator AL = 2 (over level) more is detected after 30 minutes has passed since the outdoor unit was stopped, it is treated as the first detection and ① above is repeated.</p>	<p>1) Excessive refrigerant charge.</p> <p>2) Broken wire of liquid level heater.</p> <p>3) Poor heater output caused by control circuit board trouble.</p>	Refer to Refrigerant amount check .
			<p>4) Thermistor trouble (TH2, TH3, TH4).</p> <p>5) Thermistor input circuit trouble on control circuit board.</p> <p>6) Poor mounting of thermistor. (TH11, TH12, TH2, TH3, TH4, TH10a, TH10b)</p> <p>7) Constant capacity unit SV5b error</p> <p>8) Constant capacity unit LEV2 error</p>	<p>Check resistance of thermistor.</p> <p>Check temperature and pressure of sensor with LED monitor.</p> <p>Check thermistor mounting</p> <p>Refer to solenoid valve troubleshooting</p> <p>Refer to LEV troubleshooting</p>
			④ The unit is in an error stop delay period for 30 minutes after the outdoor unit has been stopped, during which time the error stop delay LED is displayed.	⑤ If the error pick-up prohibit switch (SW2-4) is set to ON, all detection after the 2nd detection is treated as the first detection and ① above is repeated.
1501	Lacked refrigerant abnormality (Variable capacity unit)	<p>1. When the unit condition is as follows, the compressor is stopped (1st detection) and after 3 minutes, the compressor is restarted automatically.</p> <p>• R22 refrigerant models:</p> <p>1) Cooling mode ① $F < 60 \text{ Hz}$, $\text{TH1} > 120^\circ\text{C}$, $\text{TH1-Tc} > 60\text{deg}$</p> <p>2) Heating mode ① $F < 60 \text{ Hz}$, $\text{TH1} > 100^\circ\text{C}$, $\text{TH1-Tc} > 55\text{deg}$, $\text{TH5} > 15^\circ\text{C}$ ② $F < 60 \text{ Hz}$, $\text{TH1} > 120^\circ\text{C}$, $\text{TH1-Tc} > 70\text{deg}$, $\text{TH5} \leq 15^\circ\text{C}$.</p> <p>• R407C refrigerant models: $F_1 < 60 \text{ Hz}$, $\text{TH10c} > 85^\circ\text{C}$ $F_1 \geq 60 \text{ Hz}$, $\text{TH10c} > 100^\circ\text{C}$</p> <p>2. If the temperature rises again as above within 2 hours after the outdoor unit is stopped (2nd detection), an error stop is performed, and the check code 1501 is displayed.</p> <p>3. If the temperature rises again as above within 2 hours after the outdoor unit is stopped, it becomes the first detection again, and operation is the same as in 1 above.</p> <p>4. The 2 hour period after the outdoor unit stops is the abnormal delay period, and LED display is carried out during the abnormal stop delay.</p>	<p>1) Gas leakage, insufficient gas.</p> <p>2) Overload operation.</p> <p>3) Indoor unit LEV operation is faulty.</p> <p>4) Outdoor unit LEV operation is faulty.</p> <p>5) Outdoor unit SLEV operation is faulty.</p>	<p>Refer to the item on judging the refrigerant volume.</p> <p>Check the indoor and outdoor unit operating conditions.</p> <p>Actually run the equipment in cooling or heating mode and check the operating condition.</p> <p>Cooling: Indoor LEV LEV1 SLEV Cooling: Indoor LEV SLEV</p> <p>Refer to the item concerning judging LEV failure.</p>
				<p>6) Ball valve operation is faulty.</p> <p>7) The thermistor is faulty.</p> <p>8) The control board's thermistor input circuit is faulty.</p>
	Insufficient refrigerant abnormality			

Checking code	Meaning, detecting method	Cause	Checking method & Countermeasure
1505 Suction pressure abnormality (Variable capacity unit)	<ul style="list-style-type: none"> • R22 refrigerant models: ① If it has been determined by the high pressure pressure, outlet temperature and low pressure saturation temperature that the suction pressure has approached 0 kg/cm² G (0 MPa) during compressor operation, back-up control is performed by the gas bypass. ② If the condition as in ① continues for 3 minutes, the outdoor unit is stopped and it enters the re-start prohibit mode for 3 minutes after which it is started. ③ If the same condition as in ① continues within 30 minutes after re-starting from the stopped performed in ②, and error stop is performed and "1505" is displayed. ④ This error is reset when the power supply is set to off. (The error reset cannot be performed by setting the remote controller to off for errors such as abnormal outlet temperature (error code 1102).) ⑤ The vacuum operation protection is disabled and no error detection is made after 60 minutes (cumulative) have passed since the compressor began operating after the power was turned on. ⑥ If any one of the following occurs, there will be an error delay and the unit will enter the 3-minute restart mode. Cooling If TH2 ≤ -25°C when the indoor unit is operating at 50% or more of capacity and the ambient temperature is 15 to 25°C or if the ambient temperature is 25°C or more and TH3 ≤ -15°C. Heating If TH3 < -25°C when the ambient temperature is 0°C or more. Except during defrosting, within 1 hour after recovery from defrosting or within 30 minutes of compressor operation. • R407 refrigerant models: LPS ≤ 0 kg/cm²G (0 MPa) 	<ul style="list-style-type: none"> • Operation due to accidental failure to open the ball valve, especially the ball valve for the low pressure side. Cooling: Gas side ball valve Heating: Liquid side ball valve • Temporary vacuum condition due to the uneven distribution of refrigerant (insufficient refrigerant in low pressure line) immediately after charging. • Miss matching of refrigerant piping, transmission line. • Plugging of ET capillary (CP2) (Cooling) --- R22 only • Defective mounting of TH2 thermistor. ---- R22 only 	<p>If there has been suction pressure error, do not restart operation by resetting the power supply before the following steps have been taken. (Failure to do follow these steps may cause damage to the compressor.)</p> <p><Inspection Procedure></p> <ul style="list-style-type: none"> • Check if there has been a failure to open the ball valve. • If the ball valve is open, check if the extension piping has become plugged. • Check if there is miss matching of refrigerant piping, transmission line. • Check whether or not ET(TH2) approaches the ambient temperature after the start of cooling operation. (Normally there is several degrees difference between TH2 and TH9.) ---- R22 only <p><Steps></p> <ul style="list-style-type: none"> • If the ball valve is open, check if the extension piping has become plugged. Also check if there is miss matching of piping or wiring. After these have been checked, reset the power supply to reset the error error. Next, operate the unit in the opposite mode it was in when the error occurred for 10 to 15 minutes (i.e. operate in cooling mode if the error occurred in heating mode and vice versa) (This also applies if there were none of the other problems such as plugged extension piping or failure to open the ball valve.) • If there has been no error after re-operating after checking the above, set DIPSW2-10 on the main circuit board for the outdoor unit to ON. When these dip switches are set to ON, the vacuum operation protection is disabled after 1 hour of operating time of the compressor has passed after the power has been turned on. ---- R22 only • If the temperature of TH2 continues to approach that of the ambient temperature and if it becomes 15 degrees or more higher than TH9 and the mounting condition thermistor TH2 is normal, replace the ET capillary. (When cooling only.) --- R22 only
1559 Oil balance Circuit abnormality (Constant capacity unit)	<p>① There will be an error stop during operation when there is an inadequacy in the oil balance circuit connecting the two units due to the constant capacity unit TH10b.</p>	<ul style="list-style-type: none"> • The ball valve on the oil balance pipe between the constant and variable capacity units has been left shut. • There is a problem with the constant capacity unit TH10b mounting. 	<p>When an oil balance circuit error has been detected once, before taking the following steps, do not restart using the error reset. (This could damage the compressor)</p> <p><Inspection Procedure></p> <ul style="list-style-type: none"> • Confirm that the ball valve on the oil balance pipe between the constant and variable capacity units has not been left shut. • Check the mounting of the TH10b thermistor on the constant capacity unit. (check that it has not been switched with another thermistor or removed) <p><Steps></p> <ul style="list-style-type: none"> • Open the oil balance pipe ball valves on both units. After checking the mounting of the TH10b thermistor, use the remote controller reset to make an error reset. Before restarting the unit, set the constant capacity unit control board SW3-5 to ON, then restart. (When these SW are ON, oil balance circuit abnormality is made invalid.)

Checking code		Meaning, detecting method	Cause	Checking method & Countermeasure
2500	Leakage (water) abnormality (Indoor unit)	When drain sensor detects flooding during drain pump OFF.	1) Water leak due to humidifier or the like in trouble.	Check water leaking of humidifier and clogging of drain pan.
2502	Drain pump abnormality (Indoor unit)	When indirect heater of drain sensor is turned on, rise in temperature is 20 deg. or less (in water) for 40 seconds, compared with the temperature detected before turning on the indirect heater.	1) Drain sensor sinks in water because drain water level rises due to drain water lifting-up mechanism trouble.	Check operations of drain pump.
			2) Broken wire of indirect heater of drain sensor.	Measure resistance of indirect heater of drain sensor. (Normal: Approx. 82Ω between 1-3 of CN50)
			3) Detecting circuit (circuit board) trouble.	Indoor board trouble if no other problems is detected.
2503	Drain sensor abnormality (Indoor unit)	Short/open is detected during drain pump operations. (Not detected when drain pump is not operating.) Short: 90°C or more detected Open: - 40°C or less detected	1) Thermistor trouble. 2) Poor contact of connector. (insufficient insertion) 3) Full-broken of half-broken thermistor wire.	Check resistance of thermistor. 0°C: 15 kΩ 10°C: 9.7 kΩ 20°C: 6.4 kΩ 30°C: 4.3 kΩ
	Operation of float switch (Indoor unit)	When float switch operates (point of contact: OFF), error stop is observed with code No. "2503" displayed.	1) Drain up input trouble. 2) Poor contact of float switch circuit. 3) Float switch trouble.	Check drain pump operations. Check connect contact. Check float switch operations.
4103	Reverse phase abnormality (Outdoor unit)	Reverse phase (or open phase) in the power system is being detected, so operation cannot be started.	1) The phases of the power supply (L1, L2, L3) have been reversed.	If there is reverse phase before the breaker, after the breaker or at the power supply terminal blocks TB1 or TB1A, reconnect the wiring.
			2) Open phase has occurred in the power supply (L1, L2, L3, N).	Check before the breaker, after the breaker or at the power supply terminal blocks TB1 or TB1A, and if there is an open phase, correct the connections. a) Check if a wire is disconnected. b) Check the voltage between each of the wires.
			3) The wiring is faulty.	Check 1 the connections, 2, the contact at the connector, 3, the tightening torque at screw tightening locations and 4 for wiring disconnections. TB1 ~ NF ~ TB1A ~ CNTR1 ~ F3 ~ T01 ~ CNTR Refer to the circuit number and the wiring diagram plate.
			4) The fuse is faulty.	If F3 or F1 on the MAIN board is melted, (Resistance between both ends of the fuse is ∞), replace the fuses.
			5) T01 is faulty.	To judge failure of the T01, go to "Individual Parts Failure Judgment Methods."
			6) The circuit board is faulty.	If none of the items in 1) to 5) is applicable, and if the trouble reappears even after the power is switched on again, replace the MAIN board (when replacing the circuit board, be sure to connect all the connectors, etc. securely).

Checking code		Meaning, detecting method	Cause	Checking method & Countermeasure
4106	Power off abnormality (Variable capacity unit)	① Cannot operate because the constant capacity unit is disconnected from the power source.	1) Power cord problem (constant capacity unit is disconnected from the power source) 2) Power board fuse (F01, F02) is blown. 3) Power board is defective 4) Control board is defective	Measure the voltage in each part of the constant capacity unit ① Power source terminal block (TB1) ② Power board (CN20) ③ Control board
4108	Over-current Protection (Outdoor unit)	① First detection If the 51C2 is operated during operation of the No. 2 or No. 3 compressor the outdoor unit will temporarily stop. After 3 minutes, it will restart. ② Second detection After 1 minute since the above restart, if the 51C2 operates again there will be an error stop, and "4108" will be displayed. ③ After the outdoor unit stops and the No. 2 compressor restarts there will be 1 minute during which the unit is in preliminary error stop mode. The preliminary error stop display will blink on the LED.	1) Heavy-load operations exceeding the unit's capacity. 2) Power source abnormality a. Power source voltage drop b. Power source voltage defect 3) Defective power cord 4) Defective compressor a. Compressor open phase, earth fault b. Compressor lock-up	<ul style="list-style-type: none"> Confirm unit operation conditions Voltage check on power source terminal block TB1 Open phase check 52C2 connector, power cord check Power cord check, compressor resistance check. (Mega-check) Operate in no-load status. Remove the compressor power cord, check the power cord insulation and operate. → If there is no abnormality when 52C2 is turned ON, the compressor is defective.
4115	Power supply sync signal abnormality (Variable capacity unit)	The frequency cannot be determined when the power is switched on. (The power supply's frequency cannot be detected. The outdoor fan cannot be controlled by phase control.)	1) There is an open phase in the power supply (L1, L2, L3, N). 2) The power supply voltage is distorted. 3) A fuse is defective. 4) T01 is defective. 5) The circuit board is defective.	<p>Check before the breaker, after the breaker or at the power supply terminal blocks TB1 or TB1A, and if there is an open phase, correct the connections.</p> <p>If the power supply voltage waveform is distorted from a sine wave, improve the power supply environment.</p> <p>If F1 on the MAIN board, or F3 is melted, (Resistance between both ends of the fuse is ∞), replace the fuses.</p> <p>To judge failure of the T01, go to "Individual Parts Failure Judgment Methods."</p> <p>If none of the items in 1) to 4) is applicable, and if the trouble reappears even after the power is switched on again, replace the MAIN board (when replacing the circuit board, be sure to connect all the connectors, ground wires, etc. securely).</p>

Checking code		Meaning, detecting method	Cause	Checking method & Countermeasure
4116	Fan speed abnormality (motor abnormality) (Indoor unit)	Detects only for PKFY-VAM) 1. Detecting fan speed below 180rpm or over 2000rpm during fan operation at indoor unit (first detection) enters into the 3-minute restart prevention mode to stop fan for 30 seconds. 2. When detecting fan speed below 180rpm or over 2000rpm again at fan returning after 30 seconds from fan stopping, error stop (fan also stops) will be commenced displaying 4116.	1) Slipping off of fan speed detecting connector (CN33) of indoor controller board.	• Confirm slipping off of connector (CN33) on indoor controller board.
			2) Slipping off of fan output connector (FAN1) of indoor power board.	• Confirm slipping off of connector (FAN1) on indoor power board.
			3) Disconnection of fan speed detecting connector (CN33) of indoor controller board, or that of fan output connector (FAN1) of indoor power board.	• Check wiring for disconnection.
			4) Filter clogging.	• Check filter.
			5) Trouble of indoor fan motor.	• Check indoor fan motor.
			6) Faulty fan speed detecting circuit of indoor controller board, or faulty fan output circuit of indoor power board.	• When aboves have no trouble. 1) For trouble after operating fan. Replace indoor controller board. If not remedied, replace indoor power board. 2) For trouble without operating fan. Replace indoor power board.
4200	VDC sensor/circuit abnormality (Variable capacity unit)	① If $VDC \leq 304 V$ is detected just before the inverter starts. ② If $VDC \geq 750 V$ is detected just before starting of and during operation of the inverter.	1) Power supply voltage is abnormal.	• Check if an instantaneous power failure or power failure, etc. has occurred. • Check if the voltage is the rated voltage value.
			2) The wiring is defective.	Check 1, the connections, 2, contact at the connectors, 3 tightening torque at screw tightened portions, 4, wiring polarities, 5, for broken wires, and 6, for grounding in the following wiring. TB1A ~ DS ~ [52C, R1, R5] ~ [C2, C3] ~ TRM Wiring TRM ~ CNVDC Wiring * Check if the wiring polarities are as shown on the electric wiring diagram plate.
			3) The rush current prevention resistors (R1, 5) are defective.	To judge failure of R1 and R5, go to "Individual Parts Failure Judgment Methods."
			4) The electromagnetic contactor (52C) is defective.	To judge failure of the 52C, go to "Individual Parts Failure Judgment Methods."
			5) The diode stack (DS) is defective.	To judge failure of the DS, go to "Individual Parts Failure Judgment Methods."
			6) The reactor (DCL) is defective.	To judge failure of the DCL, go to "Individual Parts Failure Judgment Methods."
			7) The INV board is defective.	If none of the items in 1) to 6) is applicable, and if the trouble reappears even after the power is switched on again, replace the INV board (when replacing the circuit board, be sure to connect all the connectors, ground wires, etc. securely).

Checking code		Meaning, detecting method	Cause	Checking method & Countermeasure
4210	Breaking of overcurrent (Variable capacity unit)	① If $IDC \geq 103$ A peak is detected during inverter operation. ② If the voltage of the INV board's sensor circuit input is what it should not normally be.	1) The power supply voltage is abnormal.	<ul style="list-style-type: none"> Check if an instantaneous power failure or power failure, etc. has occurred. Check if the voltage is the rated voltage value.
			2) The wiring is defective.	Check 1, the connections, 2, contact at the connectors, 3 tightening torque at screw tightened portions, 4, wiring polarities, 5, for broken wires, and 6, for grounding in the following wiring. TB1A ~ DS ~ [52C, R1, R5] ~ [C2, C3] ~ TRM Wiring TRM ~ CNVDC Wiring TRM ~ Compressor Wiring [CN2-1, CN2-2, CN2-3, CN3] ~ TRM Wiring * Check if the wiring polarities are as shown on the wiring diagram plate. * Check the coil resistances and insulation resistance of the compressor.
			3) The inverter/compressor is defective.	Go to "Treatment of Inverter/Compressor Related Trouble."
4220	Bus voltage abnormality (Variable capacity unit)	① If $VDC \leq 400$ V is detected during inverter operation. ② If $VDC \geq 800$ V is detected during inverter operation.	1) The power supply voltage is abnormal.	<ul style="list-style-type: none"> Check if an instantaneous stop or power failure, etc. has occurred. Check if the voltage is the rated voltage value.
			2) The wiring is defective.	Check 1, the connections, 2, contact at the connectors, 3 tightening torque at screw tightened portions, 4, wiring polarities, 5, for broken wires, and 6, for grounding in the following wiring. TB1A ~ DS ~ [52C, R1, R5] ~ [C2, C3] ~ TRM Wiring TRM ~ CNVDC Wiring * Check if the wiring polarities are as shown on the wiring diagram plate.
			3) The rush current prevention resistors (R1, 5) are defective.	To judge failure of R1 and R5, go to "Individual Parts Failure Judgment Methods."
			4) The electromagnetic contactor (52C) is defective.	To judge failure of the 52C, go to "Individual Parts Failure Judgment Methods."
			5) The diode stack (DS) is defective.	To judge failure of the DS, go to "Individual Parts Failure Judgment Methods."
			6) The reactor (DCL) is defective.	To judge failure of the DCL, go to "Individual Parts Failure Judgment Methods."
			7) The inverter output is grounded.	<ul style="list-style-type: none"> Check the wiring between the TRM and the compressor. Check the compressor's insulation resistance.
			8) The circuit board is defective.	If none of the items in 1) to 7) is applicable, and if the trouble reappears even after the power is switched on again, replace the INV board (when replacing the circuit board, be sure to connect all the connectors, ground wires, etc. securely).

Checking code		Meaning, detecting method	Cause	Checking method & Countermeasure
4230	Radiator panel overheat protection (Variable capacity unit)	If the cooling fan stays ON for 5 minutes or longer during inverter operation, and if THHS \geq 100°C is detected.	1) The wiring is defective.	Check 1 connections, 2 contact at the connectors and 3 for broken wires in the following wiring. MF1~CNFAN
			2) The INV board's fuse (F01) is defective.	If the fuse is defective, replace the fuse.
			3) The cooling fan (MF1) is defective.	To judge failure of the MF1, go to "Individual Parts Failure Judgment Methods."
			4) The THHS sensor is defective.	To judge failure of the THHS, go to error code "5110".
			5) The air passage is clogged.	If the air passage of the heat sink is clogged, clear the air passage.
			6) The INV board is defective.	If none of the items in 1) to 5) is applicable, and if the trouble reappears even after the power is switched on again, replace the INV board (when replacing the circuit board, be sure to connect all the connectors, ground wires, etc. securely).
4240	Overcurrent protection (Variable capacity unit)	If IDC \geq 66.5 A peak is detected continuously for 10 minutes during operation of the inverter after 5 or more seconds have passed since the inverter started.	1) Air passage Short Cycle.	Is the unit's exhaust short cycling?
			2) The heat exchanger is clogged.	Clean the heat exchanger.
			3) Power Supply Voltage.	If the power supply voltage is less than 342 V, it is outside specifications.
			4) External Air Temperature.	If the external air temperature is over than 43°C it is outside the specifications.
			5) Capacity Setting Error.	<ul style="list-style-type: none"> Is the indoor unit capacity total appropriate? Are the outdoor/indoor unit capacity settings appropriate?
			6) The THHS sensor is defective.	To judge failure of the THHS, go to the item for error code "5110."
			7) The solenoid valves (SV1, 2) are defective, or the solenoid valve drive circuit is defective.	To judge failure of the solenoid valve, go to "Individual Parts Failure Judgment Methods" for the "Solenoid Valve."
			8) The wiring is defective.	Check 1 connections, 2 contact at the connectors and 3 for broken wires in the following wiring. TB1A ~ [F1, F2]-SCRM-CN04~CNMF ~ MF TB1A ~ CNTR1 CNU ~ SCRM CNV ~ SCRM CNW ~ SCRM CNFC1~ CNFC2
			9) Fan motor (MF) operation is defective.	Go to "Treating Fan Motor Related Trouble."
			10) The inverter/compressor is defective.	Go to "Treating Inverter/Compressor Related Trouble."
			11) The circuit board is defective.	If none of the items in 1) to 10) is applicable, and if the trouble reappears even after the power is switched on again, replace the INV board (when replacing the circuit board, be sure to connect all the connectors, ground wires, etc. securely).

Checking code		Meaning, detecting method	Cause	Checking method & Countermeasure																																																													
4260	Cooling fan abnormality (Variable capacity unit)	If the heat sink temperature (THHS) $\geq 60^{\circ}\text{C}$ for 18 minutes or longer just before the inverter starts.	1) Same as "4230."	Same as "4230."																																																													
5101	Temperature sensor abnormality (Outdoor unit)	<p>① Detects thermistor short (high temperature pick up) during operation or open circuit (low temperature pick up). The outdoor unit is temporarily stopped and it enters the 3-minute restart prohibit mode. If the temperature detected by the thermistor immediately before the restarting is within the normal range, the unit is restarted.</p> <p>② If a short in the thermistor or an open circuit is detected immediately before restarting, an error stop is performed and one of the following numbers is displayed: 5101, 5102, 5103, 5104, 5106, 5107, 5108 or 5109.</p> <p>③ During the 3-minute restart prohibit mode, the LED for the error stop delay will be displayed.</p> <p>④ Short and open circuit detection is not performed for 10 minutes after the compressor has started operation, during defrosting and for 3 minutes after recovery from defrosting.</p> <p>⑤ Open circuit detection for thermistor TH11, 12 is not performed immediately before starting.</p>	1) Defective thermistor.	Check thermistor resistance.																																																													
5102			2) Tangled lead wires.	Check for tangled lead wires.																																																													
5103			3) Broken covering.	Checking for broken covering.																																																													
5104			4) Pin has come out of connector creating connection deerror.	Check the connector for missing pins.																																																													
5105			5) Broken wire.	Check for broken wires.																																																													
5106			6) Defective thermistor input on main circuit board.	Check pick up temperature using the LED monitor. If there is a big difference between that temperature and the actual temperature, replace the main circuit board.																																																													
5107			7) Thermistor mounting problem.	Confirm that the thermistor is mounted in the correct place.																																																													
5108			<table border="1"> <thead> <tr> <th></th> <th>Short Detection</th> <th>Open Detection</th> </tr> </thead> <tbody> <tr> <td>TH11, 12</td> <td>240°C or more (0.57 kΩ)</td> <td>15°C or less (321 kΩ)</td> </tr> <tr> <td>TH2</td> <td>70°C or more (1.14 kΩ)</td> <td>- 40°C or less (130 kΩ)</td> </tr> <tr> <td>TH3</td> <td>70°C or more (1.14 kΩ)</td> <td>- 40°C or less (130 kΩ)</td> </tr> <tr> <td>TH4</td> <td>70°C or more (1.14 kΩ)</td> <td>- 40°C or less (130 kΩ)</td> </tr> <tr> <td>TH5</td> <td>110°C or more (0.4 kΩ)</td> <td>- 40°C or less (130 kΩ)</td> </tr> <tr> <td>TH6</td> <td>110°C or more (0.4 kΩ)</td> <td>- 40°C or less (130 kΩ)</td> </tr> <tr> <td>TH7</td> <td>110°C or more (1.14 kΩ)</td> <td>- 40°C or less (130 kΩ)</td> </tr> <tr> <td>TH8</td> <td>110°C or more (0.4 kΩ)</td> <td>- 40°C or less (130 kΩ)</td> </tr> <tr> <td>TH9a, b</td> <td>70°C or more (1.14 kΩ)</td> <td>- 40°C or less (130 kΩ)</td> </tr> <tr> <td>THHS</td> <td>—</td> <td>- 40°C or less (2.5 MΩ)</td> </tr> <tr> <td>TH10a</td> <td>140°C or more (0.19 kΩ)</td> <td>- 40°C or less (130 kΩ)</td> </tr> <tr> <td>(Variable Capacity Unit)</td> <td></td> <td></td> </tr> <tr> <td>(Constant Capacity Unit)</td> <td></td> <td></td> </tr> <tr> <td>TH10b</td> <td>140°C or more (0.19 kΩ)</td> <td>- 40°C or less (130 kΩ)</td> </tr> <tr> <td>(Variable Capacity Unit)</td> <td></td> <td></td> </tr> <tr> <td>TH10b</td> <td>110°C or more (0.4 kΩ)</td> <td>- 40°C or less (130 kΩ)</td> </tr> <tr> <td>(Constant Capacity Unit)</td> <td></td> <td></td> </tr> <tr> <td>TH10c</td> <td>240°C or more (0.57 kΩ)</td> <td>- 15°C or less (1.6 MΩ)</td> </tr> <tr> <td>(Variable Capacity Unit)</td> <td></td> <td></td> </tr> </tbody> </table>			Short Detection	Open Detection	TH11, 12	240°C or more (0.57 kΩ)	15°C or less (321 kΩ)	TH2	70°C or more (1.14 kΩ)	- 40°C or less (130 kΩ)	TH3	70°C or more (1.14 kΩ)	- 40°C or less (130 kΩ)	TH4	70°C or more (1.14 kΩ)	- 40°C or less (130 kΩ)	TH5	110°C or more (0.4 kΩ)	- 40°C or less (130 kΩ)	TH6	110°C or more (0.4 kΩ)	- 40°C or less (130 kΩ)	TH7	110°C or more (1.14 kΩ)	- 40°C or less (130 kΩ)	TH8	110°C or more (0.4 kΩ)	- 40°C or less (130 kΩ)	TH9a, b	70°C or more (1.14 kΩ)	- 40°C or less (130 kΩ)	THHS	—	- 40°C or less (2.5 MΩ)	TH10a	140°C or more (0.19 kΩ)	- 40°C or less (130 kΩ)	(Variable Capacity Unit)			(Constant Capacity Unit)			TH10b	140°C or more (0.19 kΩ)	- 40°C or less (130 kΩ)	(Variable Capacity Unit)			TH10b	110°C or more (0.4 kΩ)	- 40°C or less (130 kΩ)	(Constant Capacity Unit)			TH10c	240°C or more (0.57 kΩ)	- 15°C or less (1.6 MΩ)	(Variable Capacity Unit)			
			Short Detection	Open Detection																																																													
TH11, 12			240°C or more (0.57 kΩ)	15°C or less (321 kΩ)																																																													
TH2	70°C or more (1.14 kΩ)	- 40°C or less (130 kΩ)																																																															
TH3	70°C or more (1.14 kΩ)	- 40°C or less (130 kΩ)																																																															
TH4	70°C or more (1.14 kΩ)	- 40°C or less (130 kΩ)																																																															
TH5	110°C or more (0.4 kΩ)	- 40°C or less (130 kΩ)																																																															
TH6	110°C or more (0.4 kΩ)	- 40°C or less (130 kΩ)																																																															
TH7	110°C or more (1.14 kΩ)	- 40°C or less (130 kΩ)																																																															
TH8	110°C or more (0.4 kΩ)	- 40°C or less (130 kΩ)																																																															
TH9a, b	70°C or more (1.14 kΩ)	- 40°C or less (130 kΩ)																																																															
THHS	—	- 40°C or less (2.5 MΩ)																																																															
TH10a	140°C or more (0.19 kΩ)	- 40°C or less (130 kΩ)																																																															
(Variable Capacity Unit)																																																																	
(Constant Capacity Unit)																																																																	
TH10b	140°C or more (0.19 kΩ)	- 40°C or less (130 kΩ)																																																															
(Variable Capacity Unit)																																																																	
TH10b	110°C or more (0.4 kΩ)	- 40°C or less (130 kΩ)																																																															
(Constant Capacity Unit)																																																																	
TH10c	240°C or more (0.57 kΩ)	- 15°C or less (1.6 MΩ)																																																															
(Variable Capacity Unit)																																																																	
5109	Inlet SC Coil (TH9a)																																																																
5112	Heat Exchanger Gas (TH10a)																																																																
5113	Heat Exchanger Gas (TH10b: Variable capacity unit)																																																																
5114	Distribution pipe temperature (TH10b: Constant capacity unit)																																																																
5114	Compressor shell temperature (TH10c)																																																																
5110	Radiator panel (Variable capacity unit)	If a heat sink temperature of (THHS) $\leq -40^{\circ}\text{C}$ is detected just before starting of and during operation of the inverter.	<p>1) The THHS sensor is defective.</p> <p>2) Contact is faulty.</p> <p>3) The INV board si defective.</p>	<p>Judge that the THHS has failed.</p> <p>Check the contacts of CNTH on the INV board.</p> <p>If none of the items in 1) to 2) is applicable, and if the trouble reappears even after the power is switched on again, replace the INV board (when replacing the circuit board, be sure to connect all the connectors, ground wires, etc. securely).</p>																																																													

Checking code		Meaning, detecting method	Cause	Checking method & Countermeasure
5201	Pressure sensor abnormality (Variable capacity unit)	<p>① When pressure sensor detects 1 kg/cm²G (0.098 MPa) or less during operation, outdoor unit once stops with 3 minutes restarting mode, and restarts if the detected pressure of pressure sensor exceeds 1 kg/cm²G (0.098 MPa) immediately before restarting.</p> <p>② If the detected pressure of sensor is less than 1 kg/cm²G (0.098 MPa) immediately before restarting, error stop is commenced displaying 5201.</p> <p>③ Under 3 minutes restarting mode, LED displays intermittent fault check.</p> <p>④ During 3 minutes after compressor start, defrosting and 3 minutes after defrosting operations, trouble detection is ignored.</p>	<p>1) Pressure sensor trouble.</p> <p>-----</p> <p>2) Inner pressure drop due to a leakage.</p> <p>3) Broken cover.</p> <p>4) Coming off of pin at connector portion, poor contact.</p> <p>5) Broken wire.</p> <p>6) Faulty thermistor input circuit of MAIN board.</p>	<p>Refer to Troubleshooting of pressure sensor.</p> <p>-----</p>
5301	IDC sensor/circuit abnormality (Variable capacity unit)	<ul style="list-style-type: none"> If $IDC \geq 20$ A peak is detected just before the inverter starts, or If $IDC \leq 10$ A peak is detected during inverter operation after 5 seconds has passed since the inverter started when the INV board's SW1-1 is OFF. 	<p>1) Contact is faulty.</p> <p>-----</p> <p>2) The current sensor (DCCT) is connected with reverse polarity.</p> <p>-----</p> <p>3) An error was made in the SW1-1 setting.</p> <p>-----</p> <p>4) The INV board is defective. The current sensor (DCCT) is defective.</p>	<p>Check the contacts of CNCT on the INV board.</p> <p>-----</p> <p>Check the DCCT polarity.</p> <p>-----</p> <ul style="list-style-type: none"> With SW1-1 OFF, is the inverter's output wiring open? With SW1-1 OFF, is a compressor which is not specified for this model connected to the inverter's output? <p>-----</p> <p>If none of the items in 1) to 3) is applicable, and if the trouble reappears even after the power is switched on again, replace the INV board and the DCCT (when replacing the circuit board, be sure to connect all the connectors, ground wires, etc. securely) by the following procedure.</p> <p>① Replace the INV board only. If it recovers, the INV board is defective.</p> <p>② If it does not recover, reinstall the INV board and replace the DCCT. If it recovers, the DCCT is defective.</p> <p>If it does not recover after ① and ② above, both the INV board and the DCCT are defective.</p>

(2) Communication/system

Checking code	Meaning, detecting method	Cause	Checking method & Countermeasure
6600	<p>Multiple address error</p> <p>Transmission from units with the same address is detected.</p> <div style="border: 1px solid black; padding: 5px; margin-top: 10px;"> <p>Note) The address/attribute shown on remote controller indicates the controller which has detected error.</p> </div>	<ol style="list-style-type: none"> 1) Two or more controllers of outdoor unit, indoor unit, remote controller, etc. have the same address. 2) In the case that signal has changed due to noise entered into the transmission signal. 	<p>At the generation of 6600 error, release the error by remote controller (with stop key) and start again.</p> <ol style="list-style-type: none"> a) If the error occurs again within 5 minutes → Search for the unit which has the same address with that of the source of the trouble. <div style="border: 1px solid black; padding: 5px; margin-top: 10px;"> <p>When the same address is found, turn off the power source of outdoor unit, and indoor unit for 5 minutes or more after modifying the address, and then turn on it again.</p> </div> b) When no trouble is generated even continuing operation over 5 minutes. → The transmission wave shape/noise on the transmission line should be investigated in accordance with <Investigation method of transmission wave shape/noise>.
6602	<p>Transmission processor hardware error</p> <p>Though transmission processor intends to transmit "0", "1" is displayed on transmission line.</p> <div style="border: 1px solid black; padding: 5px; margin-top: 10px;"> <p>Note) The address/attribute shown on remote controller indicates the controller which has detected error.</p> </div>	<ol style="list-style-type: none"> 1) At the collision of mutual transmission data generated during the wiring work or polarity change of the transmission line of indoor or outdoor unit while turning the power source on, the wave shape is changed and the error is detected. 2) 100 V power source connection to indoor unit. 3) Ground fault of transmission line. 4) Insertion of power supply connector (CN40) of plural outdoor units at the grouping of plural refrigerant systems. 5) Insertion of power supply connector (CN40) of plural outdoor units in the connection system with MELANS. 6) Faulty controller of unit in trouble. 7) Change of transmission data due to the noise in transmission. 8) Connection system with plural refrigerant systems or MELANS for which voltage is not applied on the transmission line for central control. 	

Checking code	Meaning, detecting method	Cause	Checking method & Countermeasure
6602	Transmission processor hardware error	Checking method and processing	
6603	Transmission circuit bus-busy error ① Collision of data transmission: Transmission can not be performed for 4 ~ 10 consecutive minutes due to collision of data transmission. ② Data can not be transmitted on transmission line due to noise for 4 ~ 10 consecutive minutes. Note) The address/attribute shown on remote controller indicates the controller which has detected error.	1) As the voltage of short frequency like noise is mixed in transmission line continuously, transmission processor can not transmit. 2) Faulty controller of generating unit.	a) Check transmission wave shape/noise on transmission line by following <Investigation method of transmission wave shape/noise>. → No noise indicates faulty controller of generating unit. → Noise if existed, check the noise.

Checking code	Meaning, detecting method	Cause	Checking method & Countermeasure
6606	<p>Communications with transmission processor error</p> <p>Communication trouble between apparatus processor and transmission processor.</p> <div data-bbox="260 405 547 566" style="border: 1px solid black; padding: 5px; margin-top: 10px;"> <p>Note) The address/attribute shown on remote controller indicates the controller which has detected error.</p> </div>	<ol style="list-style-type: none"> 1) Data is not properly transmitted due to casual erroneous operation of the generating controller. 2) Faulty generating controller. 	<p>Turn off power sources of indoor unit and outdoor unit.</p> <div data-bbox="963 315 1426 398" style="border-left: 1px solid black; border-right: 1px solid black; border-radius: 15px; padding: 5px; margin-top: 10px;"> <p>When power sources are turned off separately, microcomputer is not reset and normal operations can not be restored.</p> </div> <p>→ Controller trouble is the source of the trouble when the same trouble is observed again.</p>

		Meaning, detecting method			
6607	No ACK error	When no ACK signal is detected in 6 continuous times with 30 second interval by transmission side controller, the transmission side detects error.			
<div style="border: 1px solid black; padding: 5px; width: fit-content; margin: 0 auto;"> Note) The address/attribute shown on remote controller indicates the controller not providing the answer (ACK). </div>					
System composition	Generating unit address	Display of trouble	Detecting method	Cause	Checking method & countermeasure
(1) Single refrigerant system	① Outdoor unit (OC)	Remote controller (RC)	No reply (ACK) at IC transmission to OC	1) Poor contact of transmission line of OC or IC. 2) Damping of transmission line voltage/signal by acceptable range of transmission wiring exceeded. <div style="border: 1px solid black; padding: 2px; width: fit-content; margin: 5px auto;"> Farthest : Less than 200 m Remote controller wiring: Less than 10 m </div> 3) Erroneous sizing of transmission line (Not within the range below). Wire diameter: 1.25 mm ² or more 4) Faulty control circuit board of OC	Shut down OC unit power source, and make it again. It will return to normal state at an accidental case. When normal state can not be recovered, check for the 1) ~ 4) of the cause.
	② Indoor unit (IC)	Remote controller (RC)	No reply (ACK) at RC transmission to IC	1) When IC unit address is changed or modified during operation. 2) Faulty or slipping off of transmission wiring of IC. 3) Slipping off of IC unit connector (CN2M). 4) Faulty IC unit controller. 5) Faulty remote controller. 6) The transmission booster is defective, has disconnected wires, or the power has been cut-off.	Shut down both OC and IC power sources simultaneously for 5 minutes or more, and make them again. It will return to normal state at an accidental case. When normal state can not be recovered, check for the 1) ~ 6) of the cause.
	③ Remote controller (RC)	Remote controller (RC)	No reply (ACK) at IC transmission to RC	1) Faulty transmission wiring at IC unit side. 2) Faulty transmission wiring of RC. 3) When remote controller address is changed or modified during operation. 4) Faulty remote controller. 5) The transmission booster is defective, has disconnected wires, or the power has been cut-off.	Shut down OC power sources for 5 minutes or more, and make it again. It will return to normal state at an accidental case. When normal state can not be recovered, check for the 1) ~ 5) of the cause.

Checking code	Meaning, detecting method				
6607 (continued)	No ACK error	When no ACK signal is detected in 6 continuous times with 30 second interval by transmission side controller, the transmission side detects error.			
<div style="border: 1px solid black; padding: 5px; width: fit-content; margin: 0 auto;"> Note) The address/attribute shown on remote controller indicates the controller not providing the answer (ACK). </div>					
System composition	Generating unit address	Display of trouble	Detecting method	Cause	Checking method & countermeasure
(2) Group operation system using plural refrigerants	① Outdoor unit (OC)	Remote controller (RC)	No reply (ACK) at IC transmission to OC	As same that for single refrigerant system.	Same as measure for single refrigerant system.
	② Indoor unit (IC)	Remote controller (RC)	No reply (ACK) at RC transmission to IC	1) Cause of 1) ~ 5) of "Cause for single refrigerant system". 2) Slipping off or short circuit of transmission line of OC terminal block for centralized control (TB7). 3) Shut down of OC unit power source of one refrigerant system. 4) Neglecting insertion of OC unit power supply connector (CN40). 5) Inserting more than 2 sets of power supply connector (CN40) for centralized control use. For generation after normal operation conducted once, the following causes can be considered. <ul style="list-style-type: none"> • Total capacity error (7100) • Capacity code setting error (7101) • Connecting set number error (7102) • Address setting error (7105) 6) The transmission booster is defective, has disconnected wires, or the power has been cut-off.	a) Shut down the power source of both IC and OC for over 5 minutes simultaneously, and make them again. Normal state will be returned in case of accidental trouble. b) Check for 1) ~ 6) of causes. If cause is found, remedy it. c) Check other remote controller or OC unit LED for troubleshooting for trouble. Trouble → Modify the trouble according to the content of check code. No trouble → Faulty indoor controller
	③ Remote controller (RC)	Remote controller (RC)	No reply (ACK) at IC transmission to RC	1) Cause of 1) ~ 3) of "Cause for single refrigerant system". 2) Slipping off or short circuit of transmission line of OC terminal block for centralized control (TB7). 3) Shut down of OC unit power source of one refrigerant system. 4) Neglecting insertion of OC unit power supply connector (CN40). 5) Inserting more than 2 sets of power supply connector (CN40) for centralized control use. At generation after normal operation conducted once, the following causes can be considered. <ul style="list-style-type: none"> • Total capacity error (7100) • Capacity code setting error (7101) • Connecting set number error (7102) • Address setting error (7105) 6) The transmission booster is defective, has disconnected wires, or the power has been cut-off.	a) Shut down the power source of OC for over 5 minute, and make it again. Normal state will be returned in case of accidental trouble. b) Check for 1) ~ 6) of causes. If cause is found, remedy it. When normal state can not be obtained, check 1) ~ 6) of causes.

Checking code	Meaning, detecting method				
6607 (continued)	No ACK error	When no ACK signal is detected in 6 continuous times with 30 second interval by transmission side controller, the transmission side detects error.			
<div style="border: 1px solid black; padding: 5px; width: fit-content; margin: auto;"> (Note) The address/attribute shown on remote controller indicates the controller not providing the answer (ACK). </div>					
System composition	Generating unit address	Display of trouble	Detecting method	Cause	Checking method & countermeasure
(3) Connecting system with system controller (MELANS)	① Outdoor unit (OC)	Remote controller (RC)	No reply (ACK) at IC transmission to OC	As same that for single refrigerant system.	Same countermeasure as that for single refrigerant system.
	② Indoor unit (IC)	Remote controller (RC)	No reply (ACK) at transmission of SC to IC	Trouble of partial IC units: 1) Same cause as that for single refrigerant system.	→ Same countermeasure as that for single refrigerant system.
				Trouble of all IC in one refrigerant system: 1) Cause of total capacity error (7100) 2) Cause of capacity code setting error (7101) 3) Cause of connecting number error (7102) 4) Cause of address setting error (7105) 5) Slipping off or short circuit of transmission line of OC unit terminal block for central control (TB7). 6) Power source shut down of OC unit. 7) Trouble of OC unit electrical system. 8) The transmission booster is defective, has disconnected wires, or the power has been cut-off.	Confirm OC trouble diagnosis LED → At trouble generation, check for the content according to check code. Check the content of 5) ~ 8) shown left.
				Trouble of all IC: 1) As same that for single refrigerant system. 2) Insertion of power supply connector (CN40) into OC unit transmission line for centralized control. 3) The transmission booster is defective, has disconnected wires, or the power has been cut-off. 4) Faulty system controller (MELANS).	Confirm voltage of transmission line for centralized control • More than 20 V → Confirm 1) 2) left. • Less than 20 V → Confirm 3) left.
	③ Remote controller (RC)	Remote controller (RC)	No reply (ACK) at transmission of IC to RC	Same cause as that for plural refrigerant system.	Same countermeasure as that for plural refrigerant system.
				No reply (ACK) at transmission of MELANS to RC	Trouble of partial IC units: 1) Same cause of that for single refrigerant system.
Trouble of all IC in one refrigerant system: 1) Error detected by OC unit Total capacity error (7100) Capacity code setting error (7101) Connecting number error (7102) Address setting error (7105) 2) Slipping off or short circuit of transmission line of OC unit terminal block for central control (TB7). 3) Power source shut down of OC unit. 4) Trouble of OC unit electrical system. 5) The transmission booster is defective, has disconnected wires, or the power has been cut-off.					Confirm OC trouble diagnosis LED → At trouble generation, check for the content according to check code. Check the content of 2) ~ 5) shown left.
Trouble of all IC: 1) As same that for single refrigerant system. 2) Insertion of power supply connector (CN40) into OC unit transmission line for centralized control. 3) The transmission booster is defective, has disconnected wires, or the power has been cut-off. 4) Faulty MELANS.	Check the causes of 1) ~ 4) left.				

Checking code	Meaning, detecting method				
6607 (continued)	No ACK error	When no ACK signal is detected in 6 continuous times with 30 second interval by transmission side controller, the transmission side detects error. <div style="border: 1px solid black; padding: 5px; width: fit-content; margin: 10px auto;"> Note) The address/attribute shown on remote controller indicates the controller not providing the answer (ACK). </div>			
System composition	Generating unit address	Display of trouble	Detecting method	Cause	Checking method & countermeasure
(3) Connecting system with system controller (MELANS)	④ System controller (SC)	Remote controller (RC)	No reply (ACK) at transmission of IC to SC	Trouble of partial remote controller: 1) Faulty wiring of RC transmission line. 2) Slipping off or poor contact of RC transmission connector. 3) Faulty RC. 4) The transmission booster is defective, has disconnected wires, or the power has been cut-off.	Check 1) ~ 4) left.
				Trouble of all IC in one refrigerant system. 1) Error detected by OC unit Total capacity error (7100) Capacity code setting error (7101) Connecting number error (7102) Address setting error (7105) 2) Slipping off or short circuit of transmission line of OC unit terminal block for central control (TB7). 3) Power source shut down of OC unit. 4) Trouble of OC unit electrical system. 5) The transmission booster is defective, has disconnected wires, or the power has been cut-off.	Confirm OC trouble diagnosis LED → At trouble generation, check for the content according to check code. Check the content of 2) ~ 5) shown left.
				Trouble of all RC: 1) As same that for single refrigerant system. 2) Inserting supply power connector (CN40) to OC transmission line for centralized control. 3) The transmission booster is defective, has disconnected wires, or the power has been cut-off. 4) Faulty MELANS.	Check the causes 1) ~ 4) left.
No relation with system	Address which should not be existed	-	-	1) IC unit is keeping the memory of the original group setting with RC although the RC address was changed later. The same symptom will appear for the registration with SC. 2) IC unit is keeping the memory of the original interlocking registration with Fresh Master with RC although the Fresh Master address was changed later.	As some IC units are keeping the memory of the address not existing, delete the information. Employ one of the deleting method among two below. 1) Deletion by remote controller. Delete unnecessary information by the manual setting function of remote controller. 2) Deletion by connecting information deleting switch of OC unit. <div style="border: 1px solid black; padding: 5px; width: fit-content; margin: 10px auto;"> Be careful that the use of this method will delete all the group information set with RC and all the interlocking information of Fresh Master and IC unit. </div> <ol style="list-style-type: none"> ① Shut down OC unit power source, and wait for 5 minutes. ② Turn on the dip switch SW2-2 provided on OC unit control circuit board. ③ Make OC unit power source, and wait for 5 minutes. ④ Shut down OC unit power source, and wait for 5 minutes. ⑤ Turn off the dip switch SW2-2 provided on OC unit control circuit board. ⑥ Make OC unit power source.

Checking code	Meaning, detecting method	Cause	Checking method & Countermeasure
6608	<p>No response error</p> <p>Though acknowledgement of receipt (ACK) is received after transmission, no response command is returned. Detected as error by transmission side when the same symptom is re-peated 10 times with an interval of 3 seconds.</p> <div style="border: 1px solid black; padding: 5px; margin-top: 10px;"> <p>Note) The address/attribute shown on remote controller indicates the controller which has detected error.</p> </div>	<ol style="list-style-type: none"> 1) At the collision of mutual transmission data when transmission wiring is modified or the polarity is changed while turning the power source on, the wave shape changes detecting error. 2) Repeating of transmission error due to noise. 3) Damping of transmission line voltage/signal due to exceeding of the acceptable range for transmission wiring. <ul style="list-style-type: none"> • Farthest Less than 200 m • RC wiring Less than 12 m 4) Damping of transmission voltage/signal due to improper type of transmission line. <ul style="list-style-type: none"> • Wire size: More than 1.25 mm² 	<ol style="list-style-type: none"> a) Generation at test run Turn off the power sources of OC unit, IC unit and Fresh Master for more than 5 minutes simultaneously, and make them again. → Returning to normal state means the trouble detection due to transmission line work while powering. b) Check 3) and 4) of the causes left. c) Investigate the transmission wave shape/noise on transmission line according to <Investigation method of transmission wave shape/noise>. <div style="border: 1px solid black; border-radius: 10px; padding: 5px; margin-top: 10px; text-align: center;"> <p>Much possibility if 6602 is generated.</p> </div>

(3) System error

Checking code	Meaning, detecting method	Cause	Checking method & Countermeasure																																												
7100	<p>Total capacity error</p> <p>Total capacity of indoor units in the same refrigerant system exceeds limitations.</p> <div style="border: 1px solid black; padding: 5px; margin-top: 10px;"> <p>Error source: Outdoor unit</p> </div>	<ol style="list-style-type: none"> 1) Total capacity of indoor units in the same refrigerant system exceeds the following: <table border="1" style="margin: 10px auto; border-collapse: collapse; text-align: center;"> <thead> <tr> <th>Model</th> <th>Total capacity</th> </tr> </thead> <tbody> <tr><td>PUHY-400</td><td>520</td></tr> <tr><td>PUHY-500</td><td>650</td></tr> <tr><td>PUHY-600</td><td>780</td></tr> <tr><td>PUHY-650</td><td>845</td></tr> <tr><td>PUHY-700</td><td>910</td></tr> <tr><td>PUHY-750</td><td>975</td></tr> </tbody> </table> 2) Erroneous setting of OC model selector switch (SW3-10). <div style="text-align: center; margin-top: 10px;"> <table style="border-collapse: collapse;"> <tr> <td style="padding: 0 5px;">1</td><td style="padding: 0 5px;">2</td><td style="padding: 0 5px;">3</td><td style="padding: 0 5px;">4</td><td style="padding: 0 5px;">5</td><td style="padding: 0 5px;">6</td><td style="padding: 0 5px;">7</td><td style="padding: 0 5px;">8</td><td style="padding: 0 5px;">9</td><td style="padding: 0 5px;">10</td> </tr> <tr> <td style="border: 1px solid black; width: 15px; height: 15px;"></td><td style="border: 1px solid black; width: 15px; height: 15px;"></td><td style="border: 1px solid black; width: 15px; height: 15px;"></td><td style="border: 1px solid black; width: 15px; height: 15px;"></td><td style="border: 1px solid black; width: 15px; height: 15px;"></td><td style="border: 1px solid black; width: 15px; height: 15px;"></td><td style="border: 1px solid black; width: 15px; height: 15px;"></td><td style="border: 1px solid black; width: 15px; height: 15px;"></td><td style="border: 1px solid black; width: 15px; height: 15px;"></td><td style="border: 1px solid black; width: 15px; height: 15px;"></td> </tr> <tr> <td colspan="10" style="text-align: center;">SW3</td> </tr> </table> </div> 	Model	Total capacity	PUHY-400	520	PUHY-500	650	PUHY-600	780	PUHY-650	845	PUHY-700	910	PUHY-750	975	1	2	3	4	5	6	7	8	9	10											SW3										<ol style="list-style-type: none"> a) Check for the model total (capacity cord total) of indoor units connected. b) Check whether indoor unit capacity code (SW2) is wrongly set. <p style="margin-top: 10px;">For erroneous switch setting, modify it, turn off power source of outdoor unit, and indoor unit simultaneously for 5 minutes or more to modify the switch for setting the model name (capacity code).</p> <hr style="border-top: 1px dashed black;"/> <p>Check for the model selector switch (Dip switches SW3-10 on outdoor unit control circuit) of OC.</p>
Model	Total capacity																																														
PUHY-400	520																																														
PUHY-500	650																																														
PUHY-600	780																																														
PUHY-650	845																																														
PUHY-700	910																																														
PUHY-750	975																																														
1	2	3	4	5	6	7	8	9	10																																						
SW3																																															
7101	<p>Capacity code error</p> <p>Error display at erroneous connection of Indoor unit of which model name can not be connected.</p> <div style="border: 1px solid black; padding: 5px; margin-top: 10px;"> <p>Error source: Outdoor unit Indoor unit</p> </div>	<ol style="list-style-type: none"> 1) The Indoor unit model name (model code) connected is not connectable. Connectable range 20 ~ 250 2) Erroneous setting of the switch (SW2) for setting of model name of Indoor unit connected. 	<ol style="list-style-type: none"> a) Check for the model name of the Indoor unit connected. b) Check for the switch (SW2 if indoor controller for setting of Indoor unit model name of generating address. When it is not agreed to the model name, modify the capacity code while shutting off the power source of Indoor unit. <p>* The capacity of Indoor unit can be confirmed by the self-diagnosis function (SW1 operation) of Indoor unit.</p>																																												
7102	<p>Connected unit count over</p> <p>Number of units connected in the same refrigerant system exceeds limitations.</p> <div style="border: 1px solid black; padding: 5px; margin-top: 10px;"> <p>Error source: Outdoor unit</p> </div>	<ol style="list-style-type: none"> 1) Number of unit connected to terminal block (TB3) for outdoor/indoor transmission line exceeds limitations given be-lows: <table border="1" style="margin: 10px auto; border-collapse: collapse; text-align: center;"> <thead> <tr> <th>Model</th> <th>Total Indoor Units</th> </tr> </thead> <tbody> <tr> <td>① PU(H)Y-(P) ... YMF-B</td> <td>1 ~ 20</td> </tr> <tr> <td>② PU(H)Y-(P) ... YSMF-B</td> <td>1 ~ 32</td> </tr> </tbody> </table> 2) Slipping off of transmission wiring at Outdoor unit. 3) Short circuit of transmission line in case of 2) and 3), remote controller displays "HO". 4) When PUHN is connected with SW4-6 = OFF. 5) When PUHN is not connected with SW4-6 = ON. 	Model	Total Indoor Units	① PU(H)Y-(P) ... YMF-B	1 ~ 20	② PU(H)Y-(P) ... YSMF-B	1 ~ 32	<ol style="list-style-type: none"> a) Check whether the connection of units to the terminal block for indoor/outdoor transmission wiring (TB3) of outdoor unit is not exceeding the limitation. (See ① ~ ② left.) b) Check for 2) ~ 5). c) Check for the connection of transmission wiring to the terminal block for centralized control is erroneously connected to the indoor/outdoor transmission wiring terminal block (TB3). 																																						
Model	Total Indoor Units																																														
① PU(H)Y-(P) ... YMF-B	1 ~ 20																																														
② PU(H)Y-(P) ... YSMF-B	1 ~ 32																																														

Checking code	Meaning, detecting method	Cause	Checking method & Countermeasure
7105	Address setting error • Erroneous setting of Outdoor unit address <div style="border: 1px solid black; padding: 2px; width: fit-content;">Error source: Outdoor unit</div>	1) Setting error of Outdoor unit address The address of Outdoor unit is not being set to 51~100.	Check that the address of Outdoor unit is being set to 51 ~ 100. Reset the address if it stays out of the range, while shutting the power source off.
7110	The indoor unit will not operate because it is not correctly connected to the outdoor unit of the same refrigerant system.	1) The transmission booster is defective, has disconnected wires, or the power has been cut-off. 2) The transmission booster and outdoor unit power supplies have been cut-off.	a) Check that the power has not been cut-off due to the power supply of transmission booster being connected to the indoor unit switch. (The air conditioner will not operate correctly if the power supply of transmission booster is not turned on.) → Reset the outdoor unit power supply.
7111	Remote control sensor error Error not providing the temperature designed to remote controller sensor. <div style="border: 1px solid black; padding: 2px; width: fit-content;">Error source: Indoor unit</div>	1) In case when the old type remote controller for M-NET is used and the remote controller sensor is designed on indoor unit. (SW1-1 turned ON)	a) Replace the old remote controller by the new remote controller.
7130	Different Refrigerant unit connected error	(See Table 1)	Use the same type of refrigerant in all units included in the system.

If different units within one system are using different types of refrigerant as shown in table 1 below, the system will not operate correctly.

Table1

	Refrigerant type		
	Example 1	Example 2	Example 3
Variable capacity unit	R407C	R407C	R22
Constant capacity unit	R407C	R22	R407C
Indoor units	R22 only	–	–

[3] LED Monitor Display

(1) How to read LED for service monitor

By setting of DIP SW1-1 ~ 1-8 and SW4-2, the unit operating condition can be observed with the service LED on the MAIN board on Variable capacity unit. (For the relation of each DIP SW to the content, see the table provided. Constant capacity unit operation can also be checked if SW4-2 = ON.)

As shown in the figure below, the LED consist of 7 segments is put in 4 sets side by side for numerical and graphic display.

OC: Outdoor unit	SV : Solenoid valve	THHS : Inverter radiator panel
IC : Indoor unit	LEV : Electronic expansion valve	
	COMP: Compressor	
SW1: Variable capacity unit Main board		
E : Memory storage for service activities (sampling per minute)		

7 seg LED

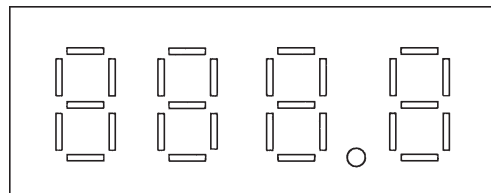

The numerical display includes that of pressure, temperature or the like, while the graphic display includes that of operating condition, solenoid valve ON/OFF state or the like.

- Numerical display

Example: Display at 18.8 kg/cm²G (1.84 MPa) of pressure sensor data (Item No. 56)

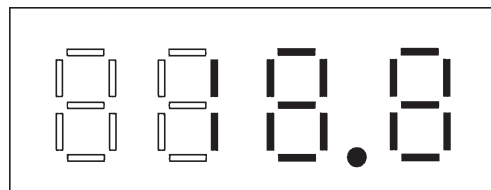

- Graphic display (Two LEDs aligned vertically express a flag.)

Example: At forcible powering in outdoor unit operation display

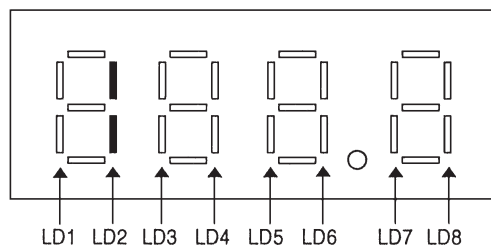

① Variable capacity unit (SW4-2 OFF)

No	SW1	Item	Display								Remarks
	12345678910		LD1	LD2	LD3	LD4	LD5	LD6	LD7	LD8	
0	0000000000	Relay Output Display 1 (Light up to display)	COMP Operating	COMP1 Operating	52C2	21S4a	SV1		SV 22/32	Lights for Normal Operation	LD8 is a relay output indicator which lights up at all times when the microcomputer's power is ON. LD8 is determined as the reverse of CH11.
		Check Display 1 OC Error	0000 ~ 9999 (Address and error code reversed)								
1	1000000000	Relay Output Display 2	SV4	21S4b	SV5b	SV6	CH2, 3	52F	Retry Operation	Emergency Operation	
2	0100000000 (Also includes IC)	Check Display 2	0000 ~ 9999 (Address and error code reversed)								If there is no error, "- - -" is displayed.
3	1100000000										
4	0010000000	Special Control	Confirmed refrigerant overcharge	Liquid correction ①	Liquid correction ②	Liquid correction ③	Liquid correction ④	Liquid correction ⑤	Liquid correction ⑥	Liquid correction ⑦	
5	1010000000	Communication Demand Volume	0000 ~ 9999								"- - -" if there is no demand control.
6	0110000000	External Signal	ON/OFF Demand	Night Mode	Snow Sensor	Auto change over mode (Cooling)	Auto change over mode (Heating)				
7	1110000000	Outdoor Unit Operation Display		Warm-up Mode	3-minute, restart	Compressor Operating	Preliminary Error	Error		Packet Being Sent	
8	0001000000	Indoor Unit Check	Unit No. 1	Unit No. 2	Unit No. 3	Unit No. 4	Unit No. 5	Unit No. 6	Unit No. 7	Unit No. 8	Lights up if an abnormal stop has occurred in the IC. The indicator for Unit No. 1 goes off when error reset is carried out from the smallest address. After No.17 unit, No.264 and 265.
9	1001000000		Unit No. 9	Unit No. 10	Unit No. 11	Unit No. 12	Unit No. 13	Unit No. 14	Unit No. 15	Unit No. 16	
10	0101000000	Indoor Unit Operation Mode	Unit No. 1	Unit No. 2	Unit No. 3	Unit No. 4	Unit No. 5	Unit No. 6	Unit No. 7	Unit No. 8	Lights up during cooling. Blinks during heating. Goes off during stop and blower operation. After No. 17 unit, No. 266 and 267.
11	1101000000		Unit No. 9	Unit No. 10	Unit No. 11	Unit No. 12	Unit No. 13	Unit No. 14	Unit No. 15	Unit No. 16	
12	0011000000	Indoor Unit Thermostat	Unit No. 1	Unit No. 2	Unit No. 3	Unit No. 4	Unit No. 5	Unit No. 6	Unit No. 7	Unit No. 8	Lights up when thermostat is ON. Goes off when thermostat is OFF. After No. 17 unit, No. 268 and 269.
13	1011000000		Unit No. 9	Unit No. 10	Unit No. 11	Unit No. 12	Unit No. 13	Unit No. 14	Unit No. 15	Unit No. 16	
14	0111000000										
15	1111000000	Outdoor Unit Operation Mode	Permission	Standby		Cooling		Heating		Demand	
16	0000100000	Outdoor Unit Control Mode	Initial Operation	Cooling Refrigerant Recovery	Heating Refrigerant Recovery	Defrost	Balance Oil	Cooling Low Oil Recovery			
17	1000100000	Error Delay in Outdoor Unit	High Pressure Error 1, 2	—	Low Pressure Error	No. 1 Discharge Temperature Error	No. 2 Discharge Temperature Error	No. 1 Over-current Protection	No. 2 Over-current Protection	Heat Sink Thermostat Operating	The flag corresponding to the item where there is an error delay lights up. Only the [Super Y] setting is valid for TH10a and TH10b.
18	0100100000		Overcurrent Break	INV Error	Refrigerant Overcharge	Configuration Detection Error	Oil Temperature Error	TH10a Error	TH10b Error		
19	1100100000		TH11 Error	TH12 Error	TH2 Error	TH3 Error	TH4 Error	TH5 Error	TH6 Error	TH7 Error	
20	0010100000		TH8 Error	TH9a Error	TH9b Error	TH10c Error	Pressure Sensor Error	THHS Error			

No	SW1	Item	Display								Remarks
	12345678910		LD1	LD2	LD3	LD4	LD5	LD6	LD7	LD8	
21	1010100000	Outdoor Unit Preliminary Error History	High Pressure Error 1, 2	—	Low Pressure Error	No. 1. Discharge Temperature Error	No. 2. Discharge Temperature Error	No. 1. Over-current Protection	No. 2. Over-current Protection	Heat Sink Thermostat Operation	Lights up if an error delay has occurred between the time the power was turned on and the present time. To turn the indicators off, switch the power OFF briefly. Only the [Super Y] setting is valid for TH10a and TH10b.
22	0110100000		Overcurrent Break	INV Error	Refrigerant Over-charge	Configuration Detection Error	Oil Temperature Error	TH10a Error	TH10b Error		
23	1110100000		TH11 Error	TH12 Error	TH2 Error	TH3 Error	TH4 Error	TH5 Error	TH6 Error	TH7 Error	
24	0001100000		TH8 Error	TH9a Error	TH9b Error	TH10c Error	Pressure Sensor Error	THHS Error			
25	1001100000	Error History 1	0000 ~ 9999								The error and error delay code are displayed. If the address and error code are shown in reverse, or there is no error, “- - -” is displayed.
26	0101100000	Inverter Error Detail	Inverter Error Detail (1 ~ 9)								If there is no error, “- - -” is displayed.
27	1101100000	Error History 2	0000 ~ 9999								
28	0011100000	Inverter Error Detail	Inverter Error Detail (1 ~ 9)								
29	1011100000	Error History 3	0000 ~ 9999								
30	0111100000	Inverter Error Detail	Inverter Error Detail (1 ~ 9)								
31	1111100000	Error History 4	0000 ~ 9999								
32	0000100000	Inverter Error Detail	Inverter Error Detail (1 ~ 9)								
33	1000100000	Error History 5	0000 ~ 9999								
34	0100100000	Inverter Error Detail	Inverter Error Detail (1 ~ 9)								
35	1100100000	Error History 6	0000 ~ 9999								
36	0010010000	Inverter Error Detail	Inverter Error Detail (1 ~ 9)								
37	1010010000	Error History 7	0000 ~ 9999								
38	0110010000	Inverter Error Detail	Inverter Error Detail (1 ~ 9)								
39	1110010000	Error History 8	0000 ~ 9999								
40	0001010000	Inverter Error Detail	Inverter Error Detail (1 ~ 9)								
41	1001010000	Error History 9	0000 ~ 9999								
42	0101010000	Inverter Error Detail	Inverter Error Detail (1 ~ 9)								
43	1101010000	Error History 10	0000 ~ 9999								
44	0011010000	Inverter Error Detail	Inverter Error Detail (1 ~ 9)								
45	1011010000	Type of Preliminary Inverter Error	1 ~ 9								If there is no error, “- - - -” is always overwritten.
46	0111010000	TH11 Data	- 99.9 ~ 999.9								
47	1111010000	TH12 Data	↑								
48	0000110000	TH2 Data	↑								
49	1000110000	TH3 Data	↑								
50	0100110000	TH4 Data	↑								
51	1100110000	TH5 Data	↑								

No	SW1 12345678910	Item	Display								Remarks
			LD1	LD2	LD3	LD4	LD5	LD6	LD7	LD8	
52	0010110000	TH6 Data	- 99.9 ~ 999.9								
53	1010110000	TH7 Data	↑								
54	0110110000	TH8 Data	↑								
55	1110110000	TH9a Data	↑								
56	0001110000	TH9b Data	↑								
57	1001110000	TH10c Data	↑								
58	0101110000	High Pressure Sensor Data	↑								
59	1101110000	Low Pressure Sensor Data	↑								
60	0011110000	THHS Data	↑								
61	1011110000										
62	0111110000	αOC	0 ~ 9.999								
63	1111110000	αOC*	↑								
64	0000001000	Accumulator Level	0 ~ 9 ("AL =" is also displayed)								
65	1000001000	TH10a	- 99.9 ~ 999.9								
66	0100001000	TH10b	↑								
67	1100001000	ΣQj	0000 ~ 9999								
68	0010001000	Target Tc	- 99.9 ~ 999.9								
69	1010001000	Target ET	↑								
70	0110001000	Tc	↑								
71	1110001000	Te	↑								
72	0001001000	Temporary Frequency	0000 ~ 9999								
73	1001001000	COMP1 Output Frequency	↑								Frequency actually output from the inverter.
74	0101001000	AK	↑								
75	1101001000	SLEV	↑								
76	0011001000	LEV1	↑								
77	1011001000	FANCON Output Value (Toff%)	↑								Displays the FANCON output value used for control.
78	0111001000	COMP1 Operating Current	↑								Displayed alternately every 5 seconds.
79	1111001000	Fan used	↑								
80	0000101000	OC Address	↑								
81	1000101000	IC1 Address/ Capacity Code	0000 ~ 9999								
82	0100101000	IC2 Address/ Capacity Code	↑								
83	1100101000	IC3 Address/ Capacity Code	↑								
84	0010101000	IC4 Address/ Capacity Code	↑								
85	1010101000	IC5 Address/ Capacity Code	↑								

When there is an error stop with No101-125, the data on error stops or the data immediately before the error postponement stop, which is stored in service memory, are displayed.

Variable capacity unit

No	SW1	Item	Display								Remarks
			LD1	LD2	LD3	LD4	LD5	LD6	LD7	LD8	
86	0110101000	IC6 Address/ Capacity Code	0000 ~ 9999								Displayed alternately every 5 seconds.
87	1110101000	IC7 Address/ Capacity Code	↑								
88	0001101000	IC8 Address/ Capacity Code	↑								
89	1001101000	IC9 Address/ Capacity Code	↑								
90	0101101000	IC10 Address/ Capacity Code	↑								
91	1101101000	IC11 Address/ Capacity Code	↑								
92	0011101000	IC12 Address/ Capacity Code	↑								
93	1011101000	IC13 Address/ Capacity Code	↑								
94	0111101000	IC14 Address/ Capacity Code	↑								
95	1111101000	IC15 Address/ Capacity Code	↑								
96	0000011000	IC16 Address/ Capacity Code	↑								
97	1000011000	COMP1 Operation Time, Higher order 4 digits	↑								
98	0100011000	Lower order 4 digits	↑								
99	1100011000	COMP2 Operation Time, Higher order 4 digits	↑								
100	0010011000	Lower order 4 digits	↑								
101	1010011000	Relay Output Display 1 Lighting Display	COMP Operating	52C1	52C2	21S4a	SV1		SV 22/32	Lights for Normal Operation	
102	0110011000	Relay Output Display 2	SV4	21S4b	SV5b	SV6	CH2, 3	52F	Retry Operation	Emergency Operation	
103	1110011000	TH11 Data	- 99.9 ~ 999.9								
104	0001011000	TH12 Data	↑								
105	1001011000	TH2 Data	↑								
106	0101011000	TH3 Data	↑								
107	1101011000	TH5 Data	↑								
108	0011011000	TH9a Data	↑								
109	1011011000	TH9b Data	↑								
110	0111011000	TH10c Data	↑								
111	1111011000	High Pressure Sensor Data	↑								
112	0000111000	Low Pressure Sensor Data	↑								
113	1000111000	THHS Data	↑								
114	0100111000	Accumulator Level	0 ~ 9 ("AL =" is also displayed)								
115	1100111000	Temporary Frequency	0000 ~ 9999								

When there is an error stop with No101-125, the data on error stops or the data immediately before the error postponement stop, which is stored in service memory, are displayed.

Variable capacity unit

No	SW1 12345678910	Item	Display								Remarks
			LD1	LD2	LD3	LD4	LD5	LD6	LD7	LD8	
116	0010111000	α OC	0 ~ 9.999								
117	1010111000	α OC*	↑								
118	0110111000	Σ Qj	0000 ~ 9999								
119	1110111000	COMP1 Output Frequency	↑								
120	0001111000	AK	↑								
121	1001111000	SLEV	↑								
122	0101111000	LEV1	↑								
123	1101111000	TH6	- 99.9 ~ 999.9								
124	0011111000	COMP1 Operating Current	0000 ~ 9999								
125	1011111000	Outdoor Unit Operation Mode		Packet Being Sent	3-minute Restart	Compressor Operating	Error Delay	Error		Vacuum Operation maintenance delay	
126	0111111000	Configuration connection value	0000 ~ 9999								
127	1111111000	CS circuit Closed Detection Time	↑								
128	0000000100	IC1 Room Temperature	- 99.9 ~ 999.9								
129	1000000100	IC2 Room Temperature	↑								
130	0100000100	IC3 Room Temperature	↑								
131	1100000100	IC4 Room Temperature	↑								
132	0010000100	IC5 Room Temperature	↑								
133	1010000100	IC6 Room Temperature	↑								
134	0110000100	IC7 Room Temperature	↑								
135	1110000100	IC8 Room Temperature	↑								
136	0001000100	IC9 Room Temperature	↑								
137	1001000100	IC10 Room Temperature	↑								
138	0101000100	IC11 Room Temperature	↑								
139	1101000100	IC12 Room Temperature	↑								
140	0011000100	IC13 Room Temperature	↑								
141	1011000100	IC14 Room Temperature	↑								

No	SW1	Item	Display								Remarks
			LD1	LD2	LD3	LD4	LD5	LD6	LD7	LD8	
142	0111000100	IC15 Room Temperature	- 99.9 ~ 999.9								
143	1111000100	IC16 Room Temperature	↑								
144	0000100100	IC1 Liquid Pipe Temperature	↑								
145	1000100100	IC2 Liquid Pipe Temperature	↑								
146	0100100100	IC3 Liquid Pipe Temperature	↑								
147	1100100100	IC4 Liquid Pipe Temperature	↑								
148	0010100100	IC5 Liquid Pipe Temperature	↑								
149	1010100100	IC6 Liquid Pipe Temperature	↑								
150	0110100100	IC7 Liquid Pipe Temperature	↑								
151	1110100100	IC8 Liquid Pipe Temperature	↑								
152	0001100100	IC9 Liquid Pipe Temperature	↑								
153	1001100100	IC10 Liquid Pipe Temperature	↑								
154	0101100100	IC11 Liquid Pipe Temperature	↑								
155	1101100100	IC12 Liquid Pipe Temperature	↑								
156	0011100100	IC13 Liquid Pipe Temperature	↑								
157	1011100100	IC14 Liquid Pipe Temperature	↑								
158	0111100100	IC15 Liquid Pipe Temperature	↑								
159	1111100100	IC16 Liquid Pipe Temperature	↑								
160	0000010100	IC1 Gas Pipe Temperature	↑								
161	1000010100	IC2 Gas Pipe Temperature	↑								
162	0100010100	IC3 Gas Pipe Temperature	↑								
163	1100010100	IC4 Gas Pipe Temperature	↑								
164	0010010100	IC5 Gas Pipe Temperature	↑								
165	1010010100	IC6 Gas Pipe Temperature	↑								
166	0110010100	IC7 Gas Pipe Temperature	↑								
167	1110010100	IC8 Gas Pipe Temperature	↑								
168	0001010100	IC9 Gas Pipe Temperature	↑								
169	1001010100	IC10 Gas Pipe Temperature	↑								
170	0101010100	IC11 Gas Pipe Temperature	↑								
171	1101010100	IC12 Gas Pipe Temperature	↑								

No	SW1 12345678910	Item	Display								Remarks
			LD1	LD2	LD3	LD4	LD5	LD6	LD7	LD8	
172	0011010100	IC13 Gas Pipe Temperature	- 99.9 ~ 999.9								
173	1011010100	IC14 Gas Pipe Temperature	↑								
174	0111010100	IC15 Gas Pipe Temperature	↑								
175	1111010100	IC16 Gas Pipe Temperature	↑								
176	0000110100	IC1 SH	↑								
177	1000110100	IC2 SH	↑								
178	0100110100	IC3 SH	↑								
179	1100110100	IC4 SH	↑								
180	0010110100	IC5 SH	↑								
181	1010110100	IC6 SH	↑								
182	0110110100	IC7 SH	↑								
183	1110110100	IC8 SH	↑								
184	0001110100	IC9 SH	↑								
185	1001110100	IC10 SH	↑								
186	0101110100	IC11 SH	↑								
187	1101110100	IC12 SH	↑								
188	0011110100	IC13 SH	↑								
189	1011110100	IC14 SH	↑								
190	0111110100	IC15 SH	↑								
191	1111110100	IC16 SH	↑								
192	0000001100	IC1 SC	↑								
193	1000001100	IC2 SC	↑								
194	0100001100	IC3 SC	↑								
195	1100001100	IC4 SC	↑								
196	0010001100	IC5 SC	↑								
197	1010001100	IC6 SC	↑								
198	0110001100	IC7 SC	↑								
199	1110001100	IC8 SC	↑								
200	0001001100	IC9 SC	↑								
201	1001001100	IC10 SC	↑								
202	0101001100	IC11 SC	↑								
203	1101001100	IC12 SC	↑								
204	0011001100	IC13 SC	↑								
205	1011001100	IC14 SC	↑								
206	0111001100	IC15 SC	↑								
207	1111001100	IC16 SC	↑								

No	SW1	Item	Display								Remarks
			LD1	LD2	LD3	LD4	LD5	LD6	LD7	LD8	
208	0000101100	IC1 LEV Opening Pulse	0000 ~ 9999								
209	1000101100	IC2 LEV Opening Pulse	↑								
210	0100101100	IC3 LEV Opening Pulse	↑								
211	1100101100	IC4 LEV Opening Pulse	↑								
212	0010101100	IC5 LEV Opening Pulse	↑								
213	1010101100	IC6 LEV Opening Pulse	↑								
214	0110101100	IC7 LEV Opening Pulse	↑								
215	1110101100	IC8 LEV Opening Pulse	↑								
216	0001101100	IC9 LEV Opening Pulse	↑								
217	1001101100	IC10 LEV Opening Pulse	↑								
218	0101101100	IC11 LEV Opening Pulse	↑								
219	1101101100	IC12 LEV Opening Pulse	↑								
220	0011101100	IC13 LEV Opening Pulse	↑								
221	1011101100	IC14 LEV Opening Pulse	↑								
222	0111101100	IC15 LEV Opening Pulse	↑								
223	1111101100	IC16 LEV Opening Pulse	↑								
224	0000011100	IC1 Operation Mode	0: Stop 1: Fan 2: Cooling 3: Heating 4: Dry								
225	1000011100	IC2 Operation Mode									
226	0100011100	IC3 Operation Mode									
227	1100011100	IC4 Operation Mode									
228	0010011100	IC5 Operation Mode									
229	1010011100	IC6 Operation Mode									
230	0110011100	IC7 Operation Mode									
231	1110011100	IC8 Operation Mode									
232	0001011100	IC9 Operation Mode									
233	1001011100	IC10 Operation Mode									
234	0101011100	IC11 Operation Mode									

No	SW1	Item	Display								Remarks
	12345678910		LD1	LD2	LD3	LD4	LD5	LD6	LD7	LD8	
235	1101011100	IC12 Operation Mode	0: Stop 1: Fan 2: Cooling 3: Heating 4: Dry								
236	0011011100	IC13 Operation Mode									
237	1011011100	IC14 Operation Mode									
238	0111011100	IC15 Operation Mode									
239	1111011100	IC16 Operation Mode									
240	0000111100	IC1 Filter	0000 ~ 9999								
241	1000111100	IC2 Filter	↑								
242	0100111100	IC3 Filter	↑								
243	1100111100	IC4 Filter	↑								
244	0010111100	IC5 Filter	↑								
245	1010111100	IC6 Filter	↑								
246	0110111100	IC7 Filter	↑								
247	1110111100	IC8 Filter	↑								
248	0001111100	IC9 Filter	↑								
249	1001111100	IC10 Filter	↑								
250	0101111100	IC11 Filter	↑								
251	1101111100	IC12 Filter	↑								
252	0011111100	IC13 Filter	↑								
253	1011111100	IC14 Filter	↑								
254	0111111100	IC15 Filter	↑								
255	1111111100	IC16 Filter	↑								
256	0000000010										
257	1000000010										
258	0100000010										
259	1100000010										
260	0010000010										
261	1010000010										
262	0110000010										
263	1110000010										
264	0001000010	Indoor Unit Check	Unit No. 17	Unit No. 18	Unit No. 19	Unit No. 20	Unit No. 21	Unit No. 22	Unit No. 23	Unit No. 24	Lights up if an abnormal stop has occurred in the IC.
265	1001000010		Unit No. 25	Unit No. 26	Unit No. 27	Unit No. 28	Unit No. 29	Unit No. 30	Unit No. 31	Unit No. 32	
266	0101000010	Indoor Unit Operation Mode	Unit No. 17	Unit No. 18	Unit No. 19	Unit No. 20	Unit No. 21	Unit No. 22	Unit No. 23	Unit No. 24	Lights up during cooling. Blinks during heating. Goes off during stop and blower operation.
267	1101000010		Unit No. 25	Unit No. 26	Unit No. 27	Unit No. 28	Unit No. 29	Unit No. 30	Unit No. 31	Unit No. 32	
268	0011000010	Indoor Unit Thermostat	Unit No. 17	Unit No. 18	Unit No. 19	Unit No. 20	Unit No. 21	Unit No. 22	Unit No. 23	Unit No. 24	Lights up when thermostat is ON. Goes off when thermostat is OFF.
269	1011000010		Unit No. 25	Unit No. 26	Unit No. 27	Unit No. 28	Unit No. 29	Unit No. 30	Unit No. 31	Unit No. 32	

No	SW1	Item	Display								Remarks
			LD1	LD2	LD3	LD4	LD5	LD6	LD7	LD8	
270	0111000010										
271	1111000010										
272	0000100010										
273	1000100010										
274	0100100010										
275	1100100010										
276	0010100010										
277	1010100010										
278	0110100010										
279	1110100010										
280	0001100010										
281	1001100010										
282	0101100010										
283	1101100010										
284	0011100010										
285	1011100010										
286	0111100010										
287	1111100010										
288	0000010010										
289	1000010010										
290	0100010010										
291	1100010010										
292	0010010010										
293	1010010010										
294	0110010010										
295	1110010010										
296	0001010010										
297	1001010010										
298	0101010010										
299	1101010010										
300	0011010010										
301	1011010010										
302	0111010010										
303	1111010010										
304	0000110010										
305	1000110010										
306	0100110010										
307	1100110010										
308	0010110010										

No	SW1	Item	Display								Remarks
			LD1	LD2	LD3	LD4	LD5	LD6	LD7	LD8	
309	1010110010										
310	0110110010										
311	1110110010										
312	0001110010										
313	1001110010										
314	0101110010										
315	1101110010										
316	0011110010										
317	1011110010										
318	0111110010										
319	1111110010										
320	0000001010										
321	1000001010										
322	0100001010										
323	1100001010										
324	0010001010										
325	1010001010										
326	0110001010										
327	1110001010										
328	0001001010										
329	1001001010										
330	0101001010										
331	1101001010										
332	0011001010										
333	1011001010										
334	0111001010										
335	1111001010										
336	0000101010										
337	1000101010	IC17 Address/ Capacity Code					0000 ~ 9999				Displayed alternately every 5 seconds.
338	0100101010	IC18 Address/ Capacity Code					↑				
339	1100101010	IC19 Address/ Capacity Code					↑				
340	0010101010	IC20 Address/ Capacity Code					↑				
341	1010101010	IC21 Address/ Capacity Code					↑				
342	0110101010	IC22 Address/ Capacity Code					↑				
343	1110101010	IC23 Address/ Capacity Code					↑				
344	0001101010	IC24 Address/ Capacity Code					↑				

No	SW1	Item	Display								Remarks
			LD1	LD2	LD3	LD4	LD5	LD6	LD7	LD8	
345	1001101010	IC25 Address/ Capacity Code	0000 ~ 9999								
346	0101101010	IC26 Address/ Capacity Code	↑								
347	1101101010	IC27 Address/ Capacity Code	↑								
348	0011101010	IC28 Address/ Capacity Code	↑								
349	1011101010	IC29 Address/ Capacity Code	↑								
350	0111101010	IC30 Address/ Capacity Code	↑								
351	1111101010	IC31 Address/ Capacity Code	↑								
352	0000011010	IC32 Address/ Capacity Code	↑								
353	1000011010										
354	0100011010										
355	1100011010										
356	0010011010										
357	1010011010										
358	0110011010										
359	1110011010										
360	0001011010										
361	1001011010										
362	0101011010										
363	1101011010										
364	0011011010										
365	1011011010										
366	0111011010										
367	1111011010										
368	0000111010										
369	1000111010										
370	0100111010										
371	1100111010										
372	0010111010										
373	1010111010										
374	0110111010										
375	1110111010										
376	0001111010										
377	1011111010										
378	0101111010										
379	1101111010										
380	0011111010										

No	SW1	Item	Display								Remarks
			LD1	LD2	LD3	LD4	LD5	LD6	LD7	LD8	
381	1011111010										
382	0111111010										
383	1111111010										
384	000000110	IC17 Room Temperature				- 99.9	~ 999.9				
385	100000110	IC18 Room Temperature					↑				
386	010000110	IC19 Room Temperature					↑				
387	110000110	IC20 Room Temperature					↑				
388	001000110	IC21 Room Temperature					↑				
389	101000110	IC22 Room Temperature					↑				
390	011000110	IC23 Room Temperature					↑				
391	111000110	IC24 Room Temperature					↑				
392	000100110	IC25 Room Temperature					↑				
393	100100110	IC26 Room Temperature					↑				
394	010100110	IC27 Room Temperature					↑				
395	110100110	IC28 Room Temperature					↑				
396	001100110	IC29 Room Temperature					↑				
397	101100110	IC30 Room Temperature					↑				
398	011100110	IC31 Room Temperature					↑				
399	111100110	IC32 Room Temperature					↑				
400	0000100110	IC17 Liquid Pipe Temperature				- 99.9	~ 999.9				
401	1000100110	IC18 Liquid Pipe Temperature					↑				
402	0100100110	IC19 Liquid Pipe Temperature					↑				
403	1100100110	IC20 Liquid Pipe Temperature					↑				
404	0010100110	IC21 Liquid Pipe Temperature					↑				
405	1010100110	IC22 Liquid Pipe Temperature					↑				
406	0110100110	IC23 Liquid Pipe Temperature					↑				
407	1110100110	IC24 Liquid Pipe Temperature					↑				

No	SW1	Item	Display								Remarks
			LD1	LD2	LD3	LD4	LD5	LD6	LD7	LD8	
408	0001100110	IC25 Liquid Pipe Temperature				↑					
409	1001100110	IC26 Liquid Pipe Temperature				↑					
410	0101100110	IC27 Liquid Pipe Temperature				↑					
411	1101100110	IC28 Liquid Pipe Temperature				↑					
412	0011100110	IC29 Liquid Pipe Temperature				↑					
413	1011100110	IC30 Liquid Pipe Temperature				↑					
414	0111100110	IC31 Liquid Pipe Temperature				↑					
415	1111100110	IC32 Liquid Pipe Temperature				↑					
416	0000010110	IC17 Gas Pipe Temperature				- 99.9	~	999.9			
417	1000010110	IC18 Gas Pipe Temperature				↑					
418	0100010110	IC19 Gas Pipe Temperature				↑					
419	1100010110	IC20 Gas Pipe Temperature				↑					
420	0010010110	IC21 Gas Pipe Temperature				↑					
421	1010010110	IC22 Gas Pipe Temperature				↑					
422	0110010110	IC23 Gas Pipe Temperature				↑					
423	1110010110	IC24 Gas Pipe Temperature				↑					
424	0001010110	IC25 Gas Pipe Temperature				↑					
425	1001010110	IC26 Gas Pipe Temperature				↑					
426	0101010110	IC27 Gas Pipe Temperature				↑					
427	1101010110	IC28 Gas Pipe Temperature				↑					
428	0011010110	IC29 Gas Pipe Temperature				↑					
429	1011010110	IC30 Gas Pipe Temperature				↑					
430	0111010110	IC31 Gas Pipe Temperature				↑					
431	1111010110	IC32 Gas Pipe Temperature				↑					
432	0000110110	IC17 SH				- 99.9	~	999.9			
433	1000110110	IC18 SH				↑					

No	SW1	Item	Display								Remarks	
	12345678910		LD1	LD2	LD3	LD4	LD5	LD6	LD7	LD8		
434	0100110110	IC19 SH					↑					
435	1100110110	IC20 SH					↑					
436	0010110110	IC21 SH					↑					
437	1010110110	IC22 SH					↑					
438	0110110110	IC23 SH					↑					
439	1110110110	IC24 SH					↑					
440	0001110110	IC25 SH					↑					
441	1001110110	IC26 SH					↑					
442	0101110110	IC27 SH					↑					
443	1101110110	IC28 SH					↑					
444	0011110110	IC29 SH					↑					
445	1011110110	IC30 SH					↑					
446	0111110110	IC31 SH					↑					
447	1111110110	IC32 SH					↑					
448	000001110	IC17 SC					- 99.9 ~ 999.9					
449	1000001110	IC18 SC					↑					
450	0100001110	IC19 SC					↑					
451	1100001110	IC20 SC					↑					
452	0010001110	IC21 SC					↑					
453	1010001110	IC22 SC					↑					
454	0110001110	IC23 SC					↑					
455	1110001110	IC24 SC					↑					
456	0001001110	IC25 SC					↑					
457	1001001110	IC26 SC					↑					
458	0101001110	IC27 SC					↑					
459	1101001110	IC28 SC					↑					
460	0011001110	IC29 SC					↑					
461	1011001110	IC30 SC					↑					
462	0111001110	IC31 SC					↑					
463	1111001110	IC32 SC					↑					
464	0000101110	IC17 LEV Opening Pulse					0000 ~ 9999					
465	1000101110	IC18 LEV Opening Pulse					↑					
466	0100101110	IC19 LEV Opening Pulse					↑					
467	1100101110	IC20 LEV Opening Pulse					↑					
468	0010101110	IC21 LEV Opening Pulse					↑					
469	1010101110	IC22 LEV Opening Pulse					↑					

No	SW1	Item	Display								Remarks
			LD1	LD2	LD3	LD4	LD5	LD6	LD7	LD8	
470	0110101110	IC23 LEV Opening Pulse				↑					
471	1110101110	IC24 LEV Opening Pulse				↑					
472	0001101110	IC25 LEV Opening Pulse				↑					
473	1001101110	IC26 LEV Opening Pulse				↑					
474	0101101110	IC27 LEV Opening Pulse				↑					
475	1101101110	IC28 LEV Opening Pulse				↑					
476	0011101110	IC29 LEV Opening Pulse				↑					
477	1011101110	IC30 LEV Opening Pulse				↑					
478	0111101110	IC31 LEV Opening Pulse				↑					
479	1111101110	IC32 LEV Opening Pulse				↑					
480	0000011110	IC17 Operation Mode									0: Stop 1: Fan 2: Cooling 3: Heating 4: Dry
481	1000011110	IC18 Operation Mode									
482	0100011110	IC19 Operation Mode									
483	1100011110	IC20 Operation Mode									
484	0010011110	IC21 Operation Mode									
485	1010011110	IC22 Operation Mode									
486	0110011110	IC23 Operation Mode									
487	1110011110	IC24 Operation Mode									
488	0001011110	IC25 Operation Mode									
489	1001011110	IC26 Operation Mode									
490	0101011110	IC27 Operation Mode									
491	1101011110	IC28 Operation Mode									
492	0011011110	IC29 Operation Mode									
493	1011011110	IC30 Operation Mode									
494	0111011110	IC31 Operation Mode									
495	1111011110	IC32 Operation Mode									

② Constant capacity unit (SW4-2 ON)

No	SW1	Item	Display								Remarks
			LD1	LD2	LD3	LD4	LD5	LD6	LD7	LD8	
0	0000000000	Relay Output Display 1 (blinking display)	COMP Operation	COMP 1 Operating		21S4a	SV1		SV2, 3 Only for the PUHN-P-YMF-B	Lights for Normal Operation	LD8 is a relay output indicator which lights up at all times when the microcomputer's power is ON. LD8 is determined as the reverse of CH11.
		Check Display 1 OC Error	0000 ~ 9999 (Address and error code reversed)								
1	1000000000	Relay Output Display 2	SV4		SV5b		CH2, 3				
2	0100000000										
3	1100000000										
4	0010000000	Special Control								Backup No. 9	
5	1010000000										
6	0110000000										
7	1110000000	Outdoor Unit (sub-unit) Operation Display			3-minute restart	Compressor operating	Preliminary Error	Error	Power off LEV open	Power off LEV closed	
8	0001000000										
9	1001000000										
10	0101000000										
11	1101000000										
12	0011000000										
13	1011000000										
14	0111000000										
15	1111000000										
16	0000100000										
17	1000100000	Outdoor Unit Error Delay	High pressure error 1, 2	—	Low pressure error	No. 1 discharge temperature error		No. 1 Overcurrent protection		Heat sink thermostat operating	The flag corresponding to the item where there is an error delay lights up.
18	0100100000				Overcurrent break		TH10a Error	TH10b Error			
19	1100100000		TH11 Error			TH3 Error	TH4 Error	TH5 Error	TH6 Error	TH7 Error	
20	0010100000		TH8 Error	TH9a Error			High pressure sensor error				
21	1010100000	Outdoor Unit Preliminary Error History	High pressure error 1, 2	—	Low pressure error	No. 1 discharge temperature error		No. 1 Overcurrent protection			Lights up if an error delay has occurred between the time the power was turned on and the present time. To turn the indicators off, switch the power OFF briefly.
22	0110100000				Overcurrent break		TH10a Error	TH10b Error			
23	1110100000		TH11 Error			TH3 Error	TH4 Error	TH5 Error	TH6 Error	TH7 Error	
24	0001100000		TH8 Error	TH9a Error							

No	SW1 12345678910	Item	Display								Remarks
			LD1	LD2	LD3	LD4	LD5	LD6	LD7	LD8	
25	1001100000										
26	0101100000										
27	1101100000										
28	0011100000										
29	1011100000										
30	0111100000										
31	1111100000										
32	0000010000										
33	1000010000										
34	0100010000										
35	1100010000										
36	0010010000										
37	1010010000										
38	0110010000										
39	1110010000										
40	0001010000										
41	1001010000										
42	0101010000										
43	1101010000										
44	0011010000										
45	1011010000										
46	0111010000	TH11 Data					- 99.9 ~ 999.9				
47	1111010000										
48	0000110000										
49	1000110000	TH3 Data					- 99.9 ~ 999.9				
50	0100110000	TH4 Data					↑				
51	1100110000	TH5 Data					↑				
52	0010110000	TH6 Data					↑				
53	1010110000	TH7 Data					↑				
54	0110110000	TH8 Data					↑				
55	1110110000	TH9 Data					↑				
56	0001110000										
57	1001110000										
58	0101110000										
59	1101110000	Low Pressure Sensor Data					- 99.9 ~ 999.9				
60	0011110000										
61	1011110000										
62	0111110000										
63	1111110000										

No	SW1	Item	Display								Remarks
			LD1	LD2	LD3	LD4	LD5	LD6	LD7	LD8	
64	0000001000	Accumulator level	0 ~ 9 ("AL =" is also displayed)								
65	1000001000	TH10a	- 99.9 ~ 999.9								
66	0100001000	TH10b	↑								
67	1100001000										
68	0010001000										
69	1010001000										
70	0110001000										
71	1110001000										
72	0001001000										
73	1001001000										
74	0101001000	AK2	0000 ~ 9999								
75	1101001000	LEV2	↑								
76	0011001000	LEV1	↑								
77	1011001000	FANCON Output Value	↑								Displays the FANCON output value used for control.
78	0111001000										
79	1111001000										
80	0000101000	OS Address	0000 ~ 9999								
81	1000101000										
82	0100101000										
83	1100101000										
84	0010101000										
85	1010101000										
86	0110101000										
87	1110101000										
88	0001101000										
89	1001101000										
90	0101101000										
91	1101101000										
92	0011101000										
93	1011101000										
94	0111101000										
95	1111101000										
96	0000011000										
97	1000011000	COMP 1 Operating Time First 4 Digits	0000 ~ 9999								
98	0100011000	Last 4 Digits	0000 ~ 9999								
99	1100011000										
100	0010011000										

**Service Handbook PUHY-400YMF-B, 500YMF-B
PUHY-P400YMF-B, P500YMF-B**

**PUHY-600YSMF-B, 650YSMF-B, 700YSMF-B, 750YSMF-B
PUHY-P600YSMF-B, P650YSMF-B, P700YSMF-B, P750YSMF-B**



HEAD OFFICE MITSUBISHI DENKI BLDG. MARUNOUCHI TOKYO 100-8310 TELEX J24532 CABLE MELCO TOKYO